

SLIMFIT

FORD F-Max H625

1848T sin spoiler



Instrucciones de Montaje

Mounting Instructions

Instructions de Montage

Montageanweisungen

Istruzioni di Montaggio

ES

EN

FR

GE

IT

Gracias por su adquisición y por confiar en nuestra gama de productos. **SLIMFIT** es un equipo de aire acondicionado diseñado y fabricado por **Dirna Bergstrom** para ser utilizado en un vehículo a motor parado durante los períodos de descanso a la sombra y/o por la noche.

SLIMFIT está diseñado con la más avanzada tecnología para lograr un eficaz rendimiento, una reducción en el gasto de combustible y en las emisiones de CO₂ a la atmósfera. Son estas características lo que lo hace único en el mercado del aire acondicionado para vehículos.



Lea atentamente este documento antes de instalar el producto. Conserve este documento para futuras consultas. La documentación original ha sido escrita en español, por lo que el resto de idiomas son traducciones.

Tiene a su disposición todos los manuales del producto en sus versiones digital (PDF) en <https://www.dirna.com/>

Cualquier operación de venta o de garantía está sometida a nuestras condiciones generales de venta en su versión más actualizada, publicada en nuestra página web <https://www.dirna.com/>

Explicación de símbolos



- **Advertencia:** Aviso de seguridad que informa sobre una situación, que de no evitarse, puede provocar lesiones graves o la muerte.



- **Peligro:** Riesgo de corte. Señala una situación que podría provocar un corte.



- **Peligro:** Riesgo de electrocución. Señala una situación que podría provocar una electrocución.



- **Aviso:** Aviso de seguridad que informa sobre una situación, que de no evitarse, puede provocar daños al equipo o a otros materiales.



- **Información:** Información adicional sobre la instalación o el manejo del producto.



- **Frágil:** Indica una situación en la que se debe operar con cuidado para no causar daños al equipo y a otros materiales.



Explicación de responsabilidades

- **Dirna Bergstrom** declina toda responsabilidad ante los daños ocasionados en los siguientes casos:

- Daños en el producto debido a influencias mecánicas y sobretensiones.
 - Modificaciones realizadas en el equipo sin el consentimiento expreso del fabricante.
 - Utilización el equipo para fines no descritos en este documento.
 - Una inadecuada manipulación o instalación del equipo.
- Queda prohibida la manipulación de los circuitos de gas refrigerante sin autorización expresa del fabricante.



Advertencias durante el montaje

- La instalación, reparación y mantenimiento de este equipo de aire acondicionado solo puede ser realizada por aquel personal técnico que posea una formación suficiente en aire acondicionado para vehículos, posibles peligros y normas aplicables.
- Leer detenidamente las instrucciones de montaje antes de iniciar la instalación del equipo. Durante la instalación, seguir al pie de la letra las instrucciones indicadas.
- Desconectar la llave de contacto antes de iniciar la instalación del equipo.
- Desconectar la batería del vehículo antes de iniciar la instalación del equipo.
- Instale **SLIMFIT** de forma segura para evitar caídas.
- Utilizar las herramientas adecuadas para cada operación.
- Durante la instalación, asegurar la conexión de los componentes eléctricos, verificando su encaje correcto.
- Si en la instalación del equipo los cableados atraviesan paredes con bordes afilados, utilice conductos o guías para evitar que los cables se dañen.
- Si durante la instalación el equipo se inclina, o la cabina se abate con el equipo instalado sobre ella, deberá esperarse un mínimo de 60 minutos, desde que el equipo quede horizontal, antes de ponerlo en marcha.
- Equipo precargado con gas refrigerante r-134a.



- **Aviso importante:** Tenga la precaución al conectar el equipo de no invertir las polaridades. Si esto sucediera, la placa de mandos no se encenderá y el equipo no se pondrá en funcionamiento.



Herramientas necesarias para el montaje

- Juego de llaves Torx
- Juego de llaves Allen
- Llave fija 13, 14, 22
- Tijeras
- Flexómetro
- Destornillador



Uso adecuado del producto

- **SLIMFIT** es un equipo de aire acondicionado de techo apropiado para ser utilizado únicamente en camiones. No es adecuada su instalación y funcionamiento en maquinaria agrícola ni de construcción sujeta a intensas vibraciones.
- El uso no conforme al previsto anula la garantía del equipo y excluye de responsabilidad al fabricante.
- Si no está seguro de cómo utilizar **SLIMFIT**, revise el manual de usuario del producto.
- Si la temperatura en la cabina de su vehículo es muy elevada para el descanso, enfríe primero la cabina con el aire acondicionado de su vehículo durante algunos minutos y después ponga en marcha **SLIMFIT** para mantener la temperatura de confort.



Documentación relacionada

- Guía rápida: 1003115344
- Manual de usuario: 1003148646
- Listado de recambios: 1003150687
- Diagnóstico de averías: 1003148649

Dirna Bergstrom declara que el equipo **SLIMFIT** cumple con los requerimientos de las siguientes Directivas CE y que se han aplicado las normas y especificaciones técnicas armonizadas enumeradas a continuación:

- Directiva CE 2014/53/EU
- Directiva CE 2011/65/EU
- Directiva CE 2014/30/EU

1 Desmontar escotilla y los elementos de fijación y entregar éstos al cliente.

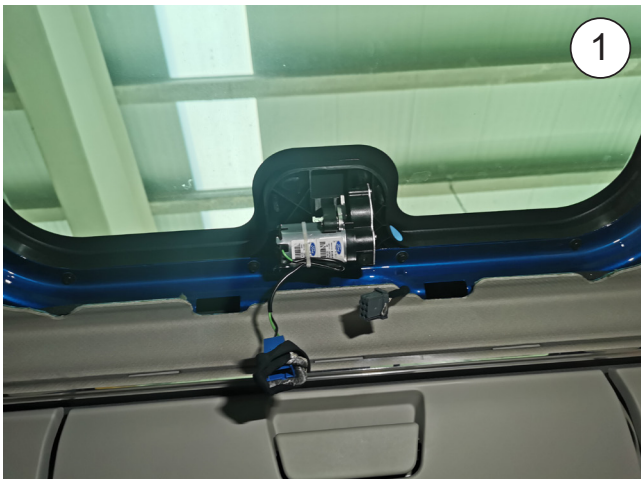
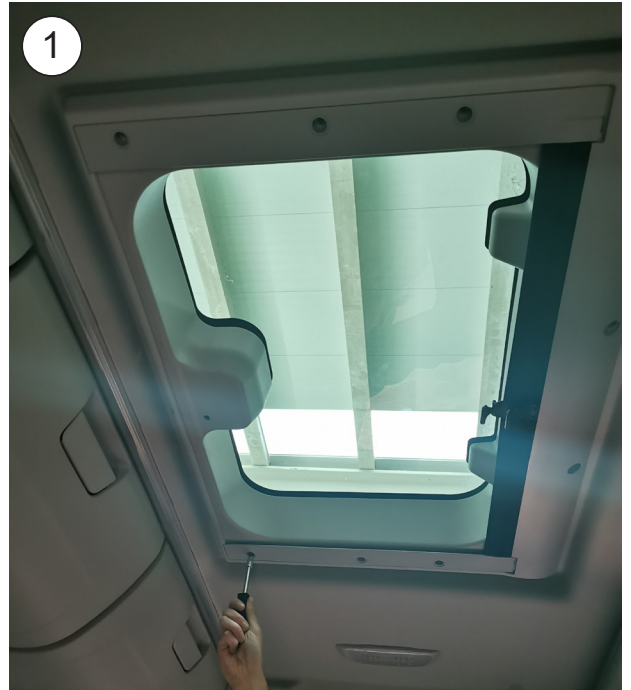

2 Pegue la junta EPDM 30x25 alrededor del hueco escotilla (mirar detalle para cortar los bordes finales de la unión de la junta).

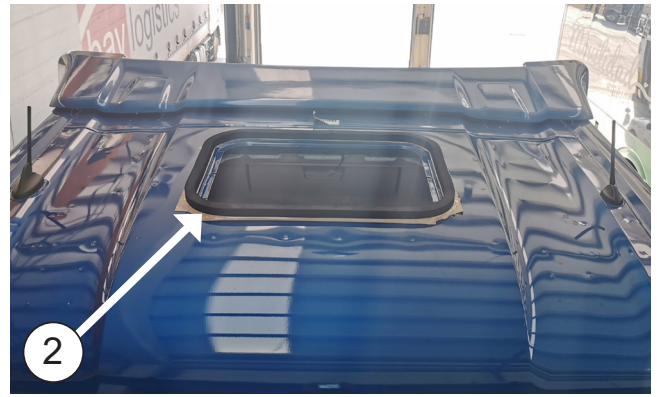

! **Atención:** La junta EPDM tiene que estar pegada junto al saliente del hueco de la escotilla.

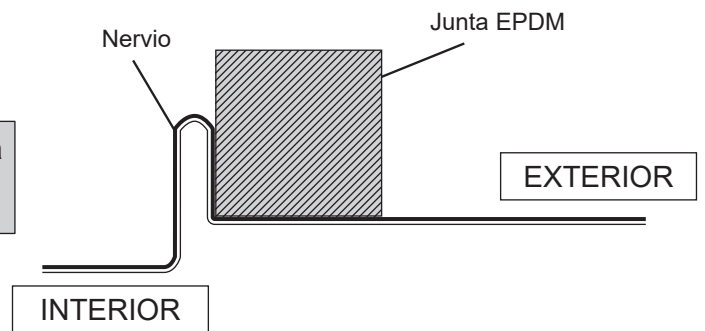

COMO CORTAR LA JUNTA EPDM PARA EVITAR FILTRACIÓN DE AGUA EN LA CABINA

A- Pegar la junta, manteniendo 100 mm de papel protector por cada lado.

B- Quita los dos piezas de papel.

C- Pegue presionado ambos finales.

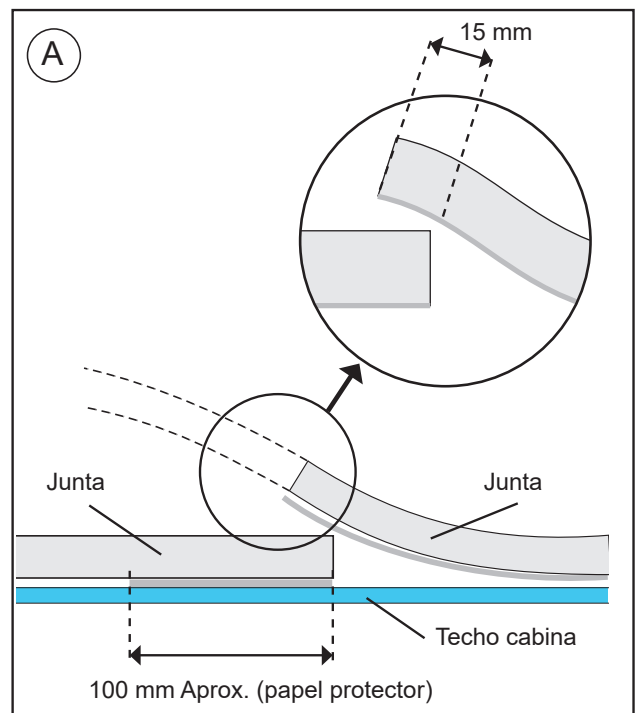

B

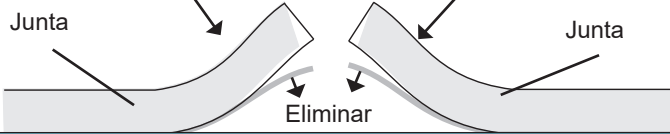

C

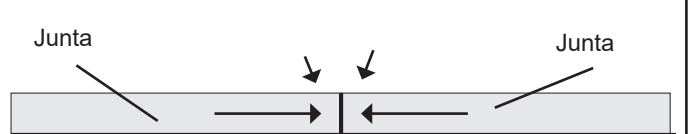

3 Posicionar el equipo sobre la junta introduciendo el panel interior de distribución en el hueco de escotilla.

¡Atención! Al colocar el equipo sobre el hueco escotilla, verificar que las salidas de desagüe no queden obstruidas por la junta EPDM.

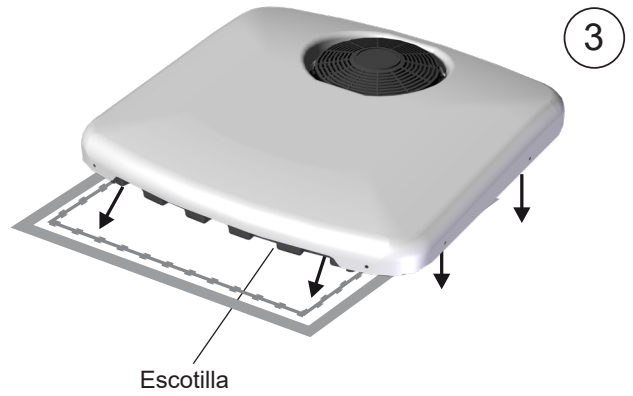

4 Roscar (4) hexágonos M8/125x26 con arandela goma, arandela plana en insertos de la base y apretar con un par de apriete de $12,7 \pm 10$ Nm.

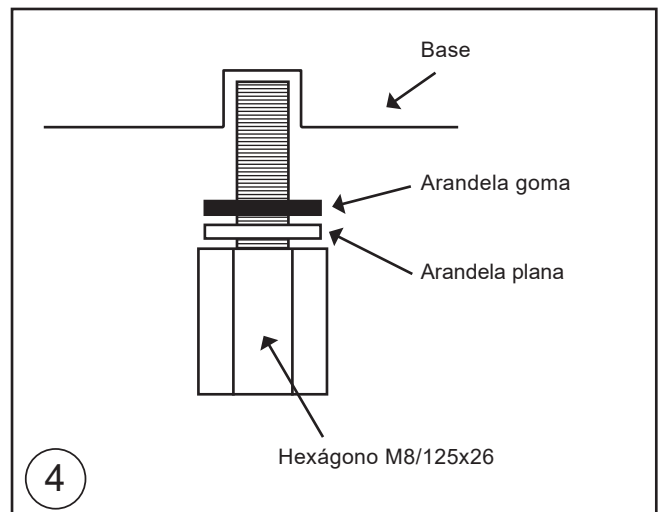
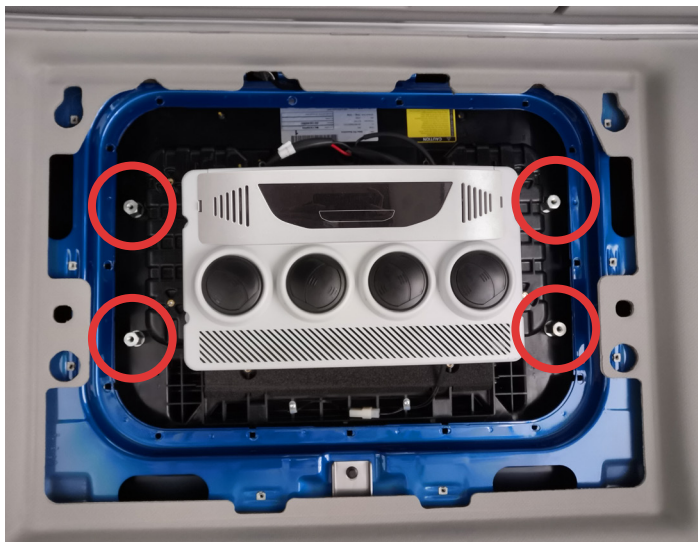

- 5** Colocar soportes de fijación con arandela plana, arandela grower y tornillo M8/125x50 **sin apretar**.



- 6** Roscar (2) hexágonos M6 L=38 en la parte trasera del equipo (sentido marcha) con arandela de goma y apretar con un par de apriete de $4,75 \pm 10\%$ Nm.

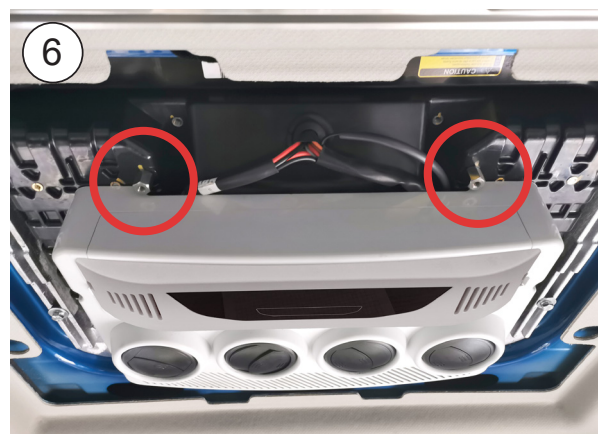

- 7** Roscar (2) hexágonos M6 L=78 en la parte delantera del equipo (sentido de la marcha) con arandela de goma y apretar con un par de apriete de $4,75 \pm 10\%$ Nm.

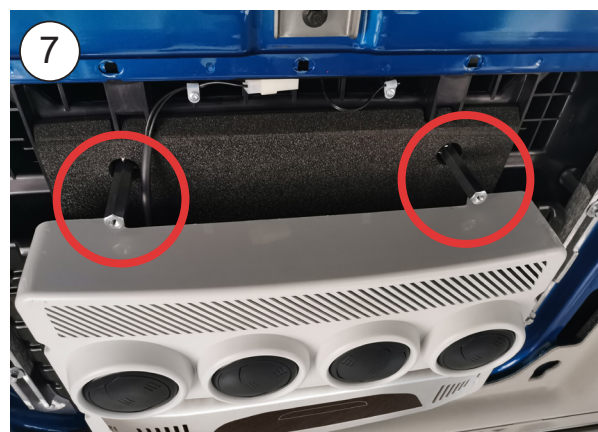

8 Presentar consola y centrar el equipo.



9 Retirar la consola y apretar tornillos M8/125x50 hasta hacer tope con los hexágonos para fijar el equipo.

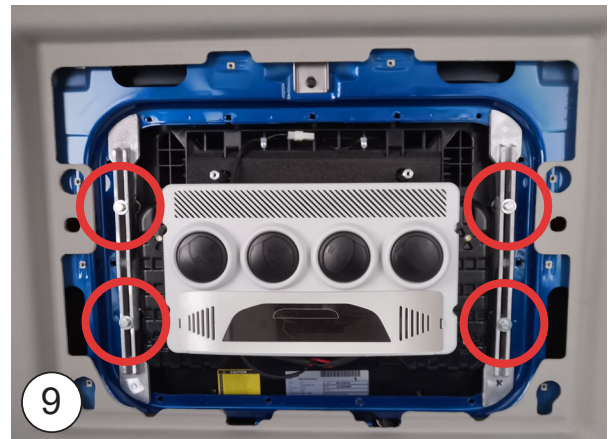

10 Montar consola con (4) tornillos M6.



Vista explosionada hasta la fijación de los soportes

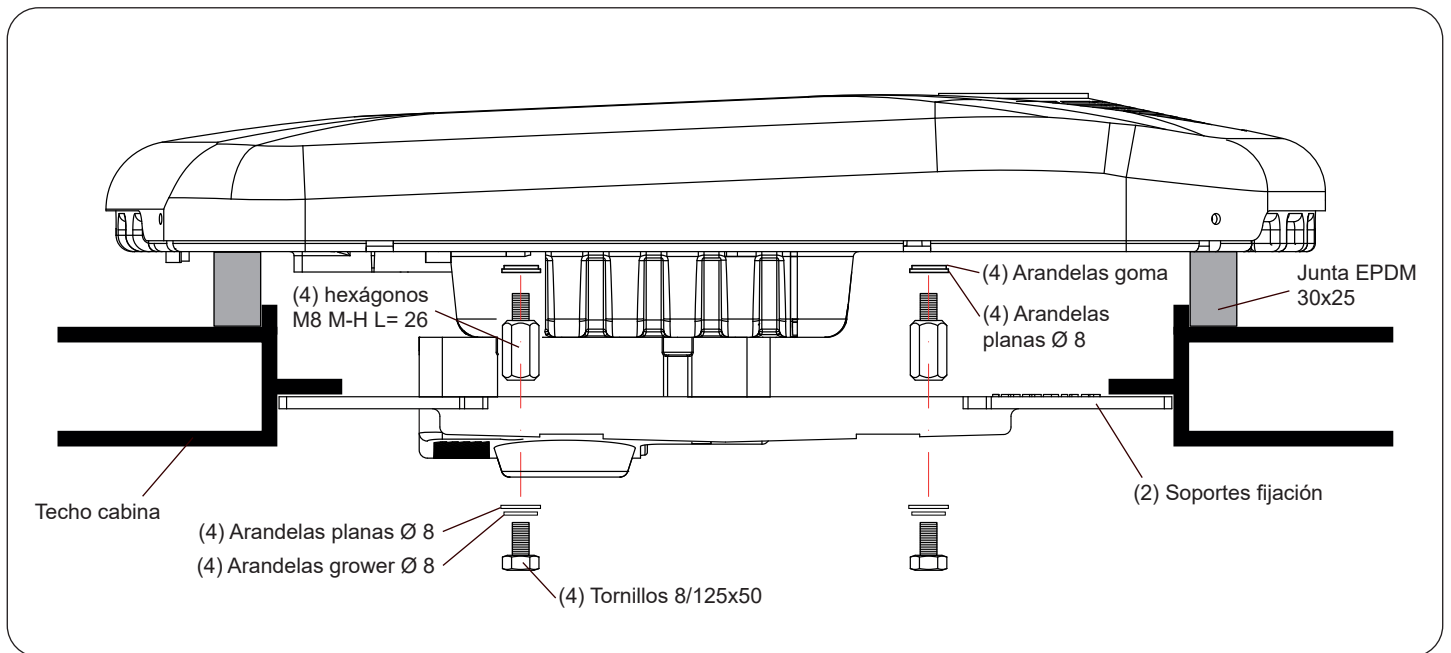

Vista explosionada lateral hasta la fijación de la consola

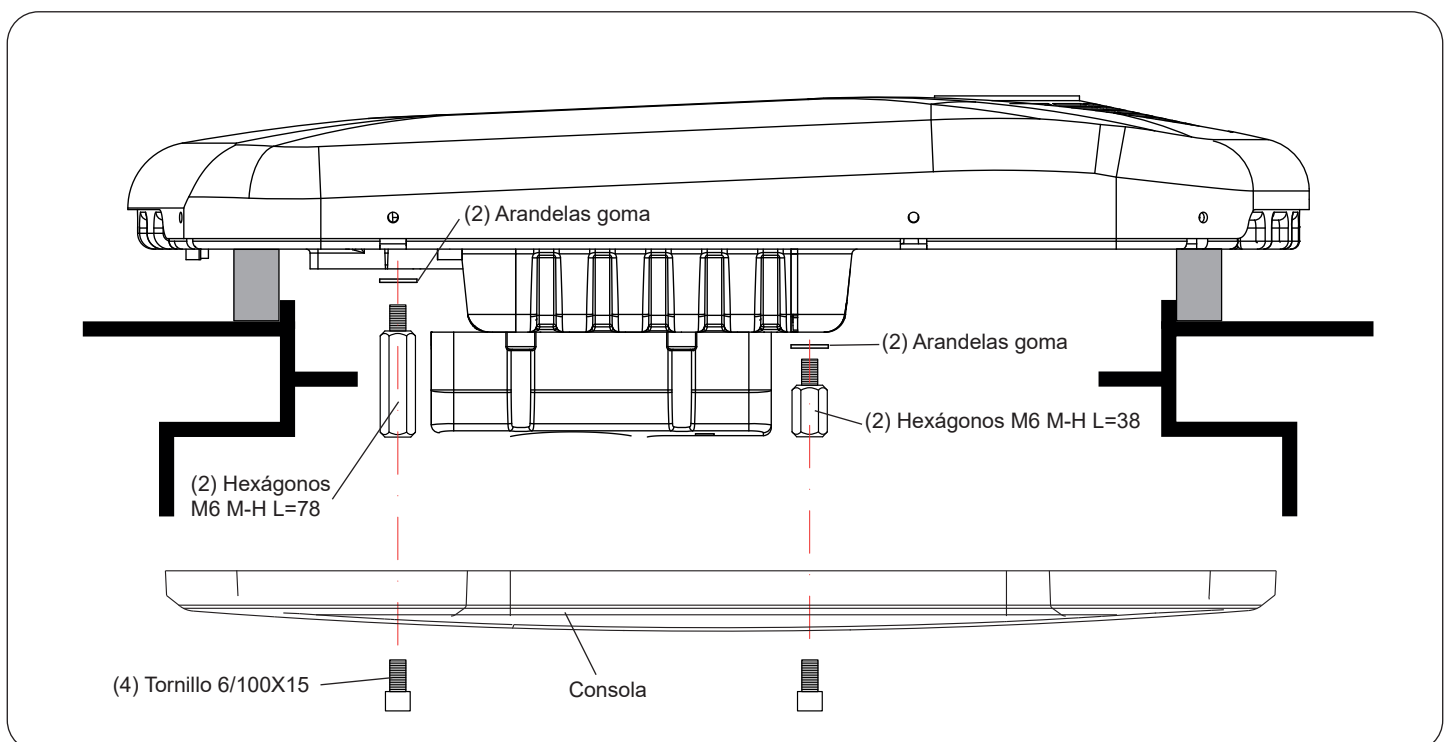

CONEXIÓN CABLEADO DE ALIMENTACIÓN



Atención: Seguir las pautas de instalación eléctrica según las indicaciones del fabricante.

1 Conectar cableado de empalme en el equipo.

2 Conectar con el conector original del vehículo.

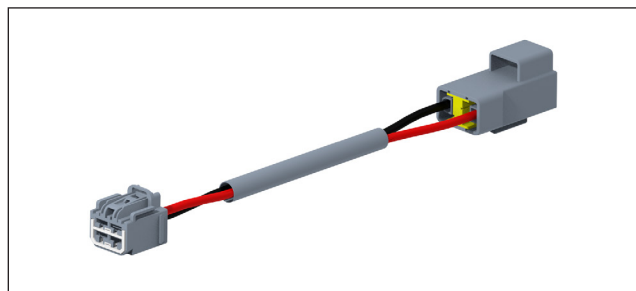

Conectar a cableado original

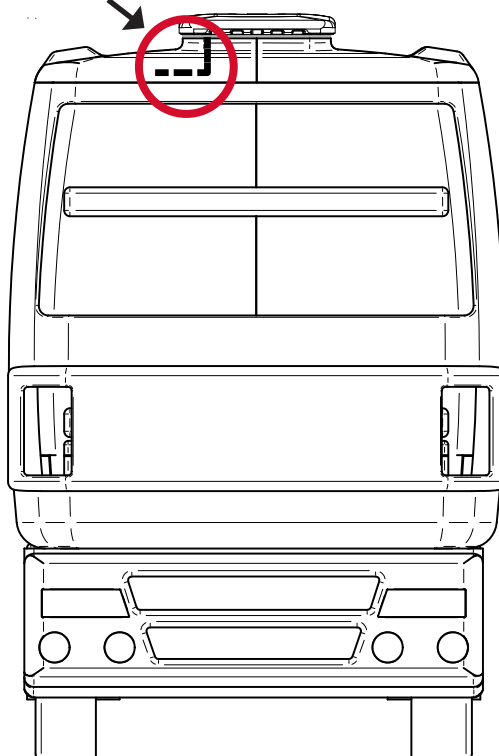

Esquema eléctrico

¡AVISO IMPORTANTE!

Precaución de no invertir las polaridades al conectar la alimentación en el equipo el display no se enciende y el equipo no funciona.

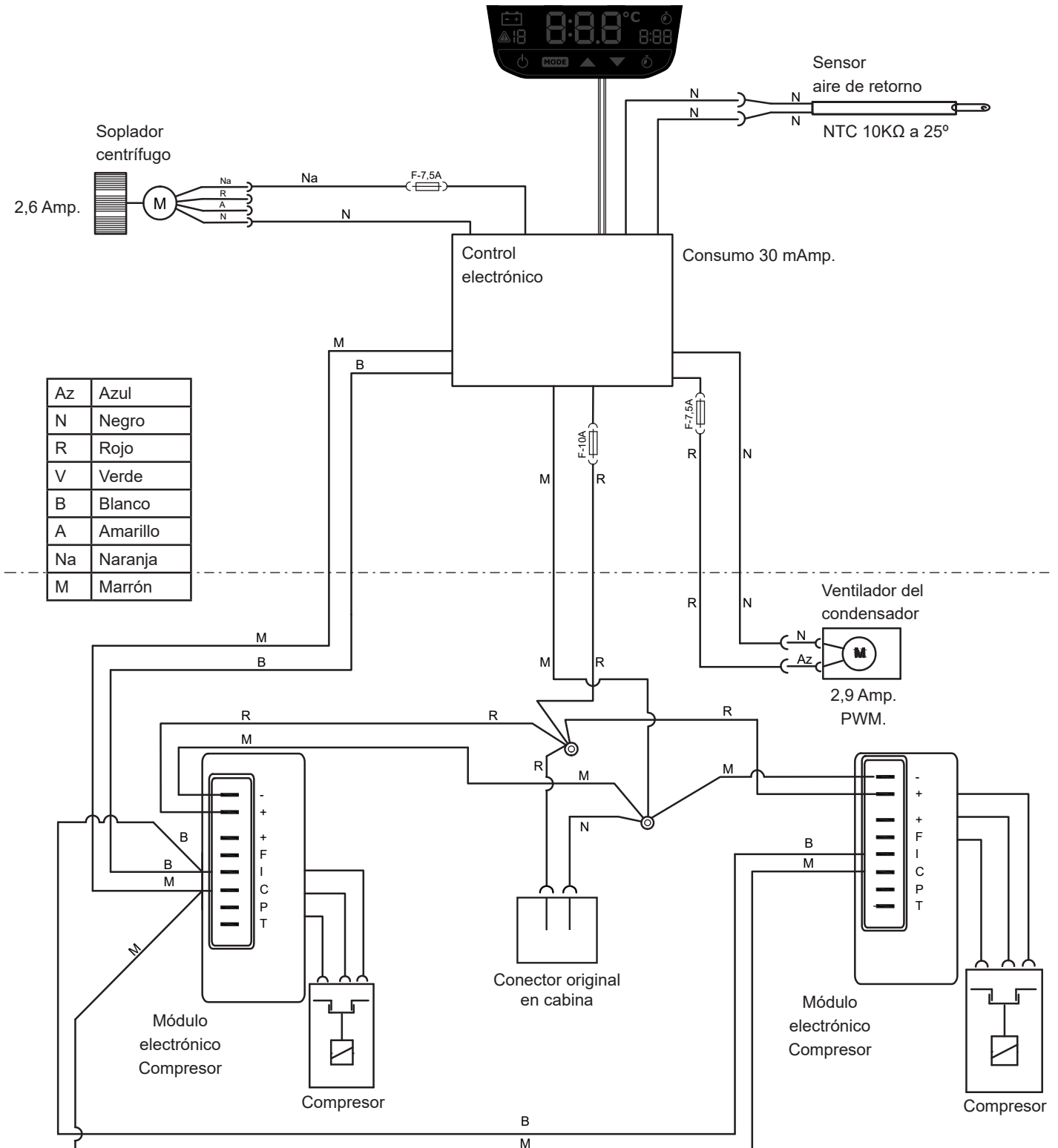

Thank you for placing your trust in our range of products. **SLIMFIT** is an air conditioning unit designed and manufactured by **Dirna Bergstrom** to run off a stationary vehicle's engine during rest periods in the shade and/or at night.

SLIMFIT is designed with cutting-edge technology to achieve high performance, reduced fuel consumption, and a lower level of CO₂ emissions. These are the features that make it unique on the vehicle air conditioning market.



Read this document carefully before installing the product. Keep this document for future reference. The original documentation was written in Spanish, all other languages are translations.

All product manuals are available in their digital versions (PDF) at <https://www.dirna.com/>

All sales and warranty transactions are subject to our general conditions of sale in their latest version, published on our website <https://www.dirna.com/>

Explanation of symbols



- **Warning:** A safety warning indicating a situation which, if not avoided, could result in death or serious injury.



- **Danger:** Cutting risk. Indicates a situation that could lead to cutting.



- **Danger:** Risk of electrocution. Indicates a situation that could lead to electrocution.



- **Caution:** Safety warning informing about a situation, which if not avoided, could result in damage to the unit or other materials.



- **Information:** Additional information on the installation or handling of the product.



- **Fragile:** Indicates a situation in which care must be taken to avoid damage to the unit and other materials.



Explanation of liability

- **Dirna Bergstrom** accepts no responsibility for damage caused in the following cases:
 - Damage to the product due to mechanical influences and surges.
 - Modifications made to the unit without the manufacturer's express consent.
 - Use of the unit for purposes not described in this document.
 - Improper handling or installation of the unit.
- It is forbidden to tamper with the refrigerant gas circuits without the manufacturer's express authorisation.



Warnings during assembly

- The installation, repair and maintenance of this air conditioning unit may only be carried out by technical staff with sufficient training in vehicle air conditioning, possible dangers and applicable standards.
- Read the installation instructions carefully before starting to install the unit. During installation, follow the instructions carefully.
- Switch off the ignition key before starting to install the unit.
- Disconnect the vehicle's battery before starting to install the unit.
- Install **SLIMFIT** securely to prevent it from falling.
- Use the appropriate tools for each operation.
- During installation, ensure the connection of the electrical components, checking that they are fitted correctly.
- If during installation of the unit the cables pass through walls with sharp edges, use conduits or guides to prevent damage to the cables.
- If during installation the unit is tilted, or the cab is tilted with the unit installed on top, you must wait at least 60 minutes after placing the unit in horizontal position before it is started.
- Unit pre-charged with r-134a refrigerant gas.
- **Important:** When connecting the unit make sure the polarities are not reversed. If this happens, the control board will not switch on and the unit will not operate.

**Tools required for assembly**

- Torx wrenches set.
- Allen wrenches set.
- Open-jawed spanner 13, 14, 22.
- Scissors.
- Flexo-meter.
- Screwdriver.

**Proper use of the product**

- **SLIMFIT** is a roof-mounted air conditioning unit suitable only for use in trucks. It is not suitable for installation and operation in agricultural or construction machinery subject to intense vibrations.
- Non-intended use will void the unit's warranty and exempts the manufacturer from any responsibility.
- If you are not sure how to use **SLIMFIT**, read the product's user manual.
- If the temperature in your vehicle's cab is too high for rest, first cool the cab with your vehicle's air conditioning for a few minutes and then run **SLIMFIT** to maintain the comfort temperature.

**Associated documentation**

- Quick guide: 1003115344
- User manual: 1003148646
- List of spare parts: 1003150687
- Troubleshooting: 1003148649

Dirna Bergstrom declares that the **SLIMFIT** unit complies with the requirements of the following EC Directives and that the harmonised standards and technical specifications listed below have been applied:

- EC Directive 2014/53/EU
- EC Directive 2011/65/EU
- EC Directive 2014/30/EU

1 Take down the hatch and the fastening elements, and hand them over to the customer.

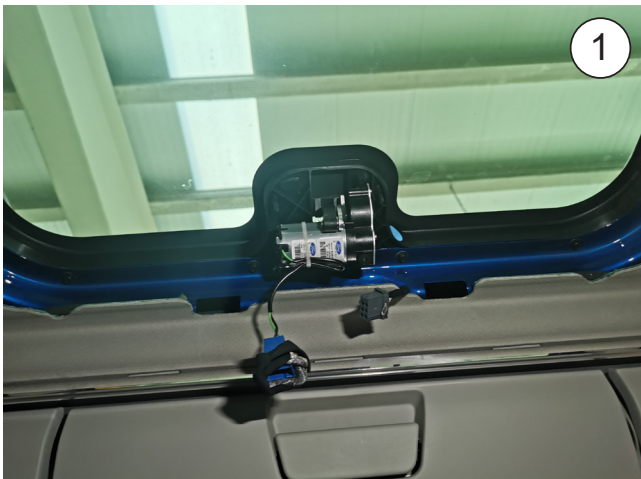

2 Attach the EPDM 30x25 seal around the hatch gap (see the details to cut the ends of the seal joint).

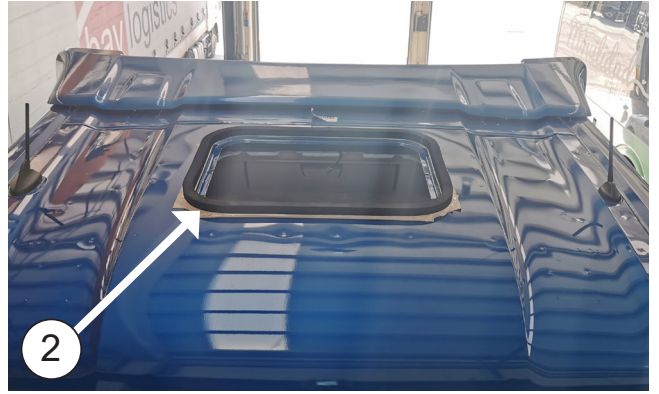

! **Take care:** The EPDM seal must be secured to the projecting edge of the hatch gap.

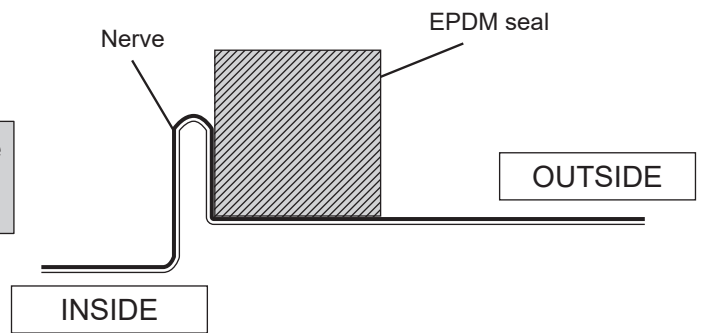

! **HOW TO CUT EPDM GASKET TO AVOID WATER FILTRATION INTO THE CABIN**

- A-** Glue gasket, keeping 100 mm of protection paper at each side.
- B-** Remove the two pieces of paper.
- C-** Glue by pressing both ends.

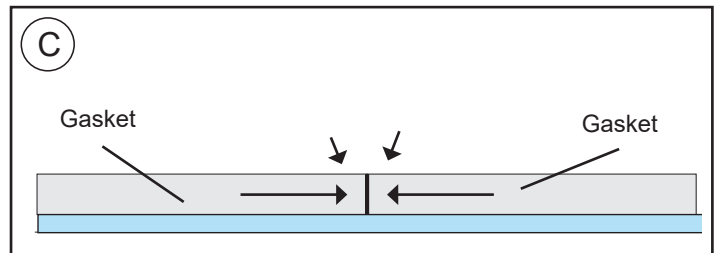
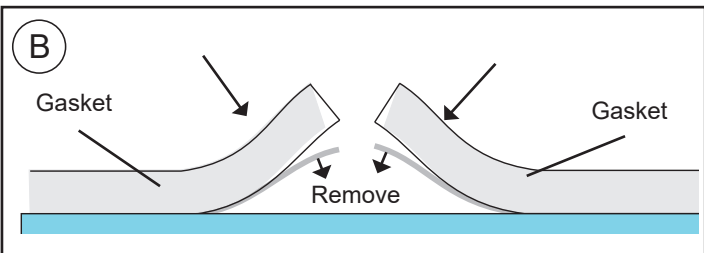
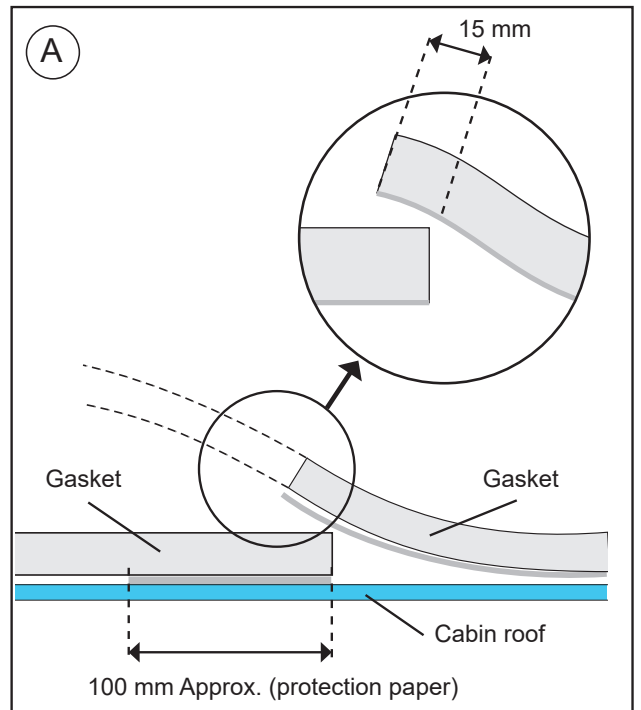

3 Position the unit on the seal, introducing the interior distribution panel in the hatch gap.

Caution! When positioning the unit above the hatch gap, check that the wastewater run-offs are not blocked by the EPDM seal.

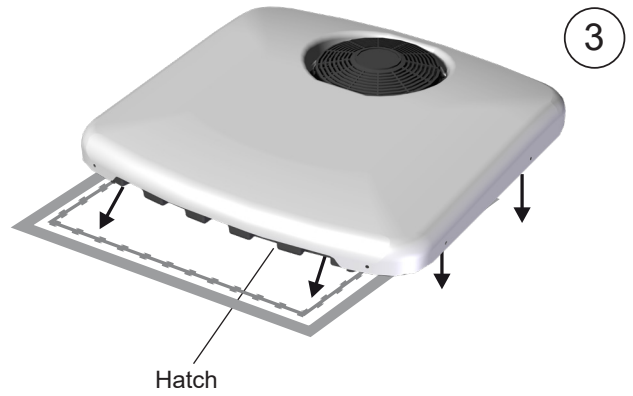

4 Screw (4) M8/125x26 hexagons with rubber washer, flat washer in the base inserts, and tighten with a torque of 12.7 ± 10 Nm.

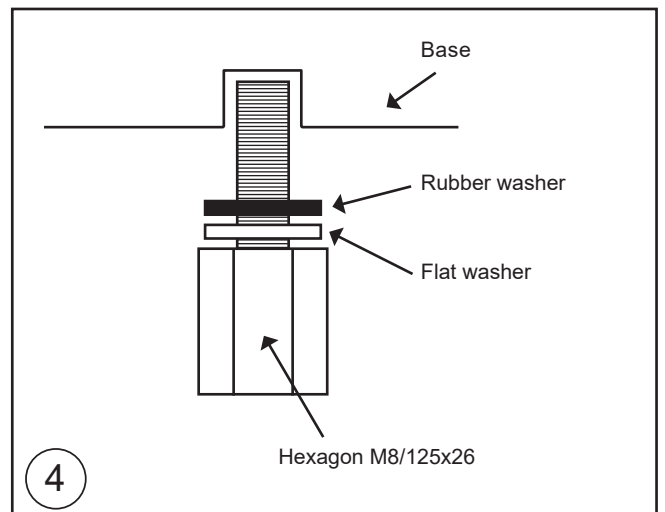
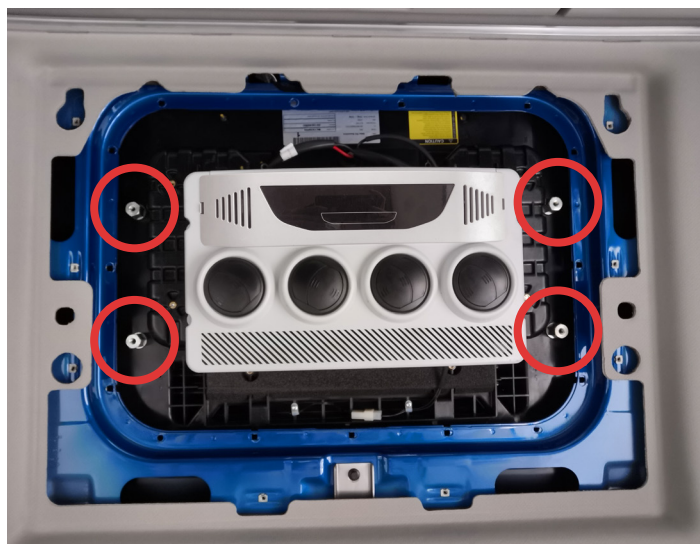

- 5** Position the fastening mounts with a flat washer, grover washer and M8/125x50 screw, **without tightening.**



- 6** Screw (2) M6 L=38 hexagons on the rear of the unit (direction of travel) with rubber washers, and tighten with a torque of $4.75 \pm 10\%$ Nm.

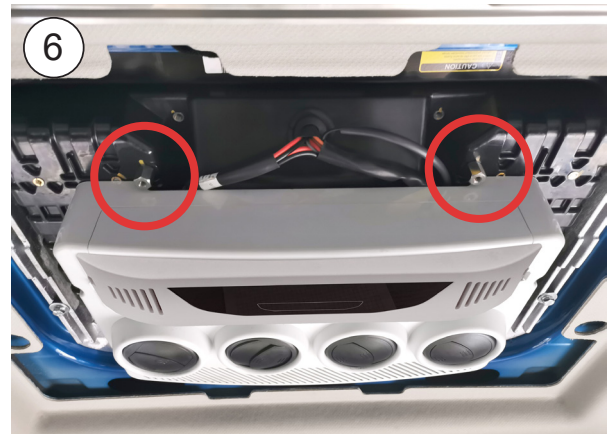

- 7** Screw (2) M6 L=78 hexagons on the front of the unit (direction of travel) with rubber washers, and tighten with a torque of $4.75 \pm 10\%$ Nm.

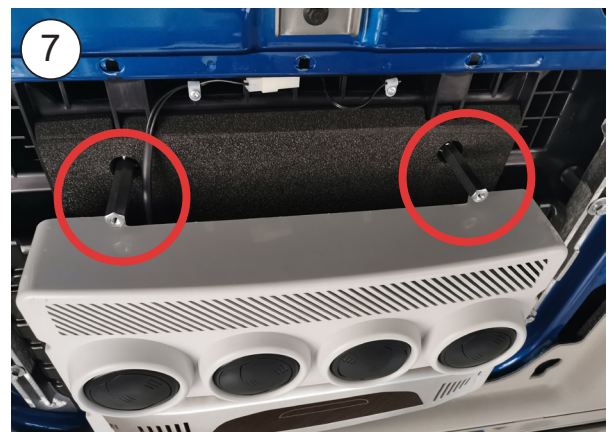

8 Position the console and align the unit.



9 Remove the console supplement and tighten M8/125x50 screws until it comes up against the hexagons, in order to secure the unit.

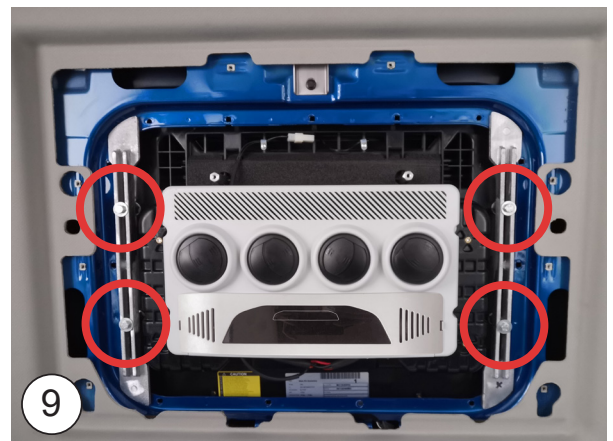

10 Mount the console with (4) M6 screws.



Exploded view through to mount fastenings

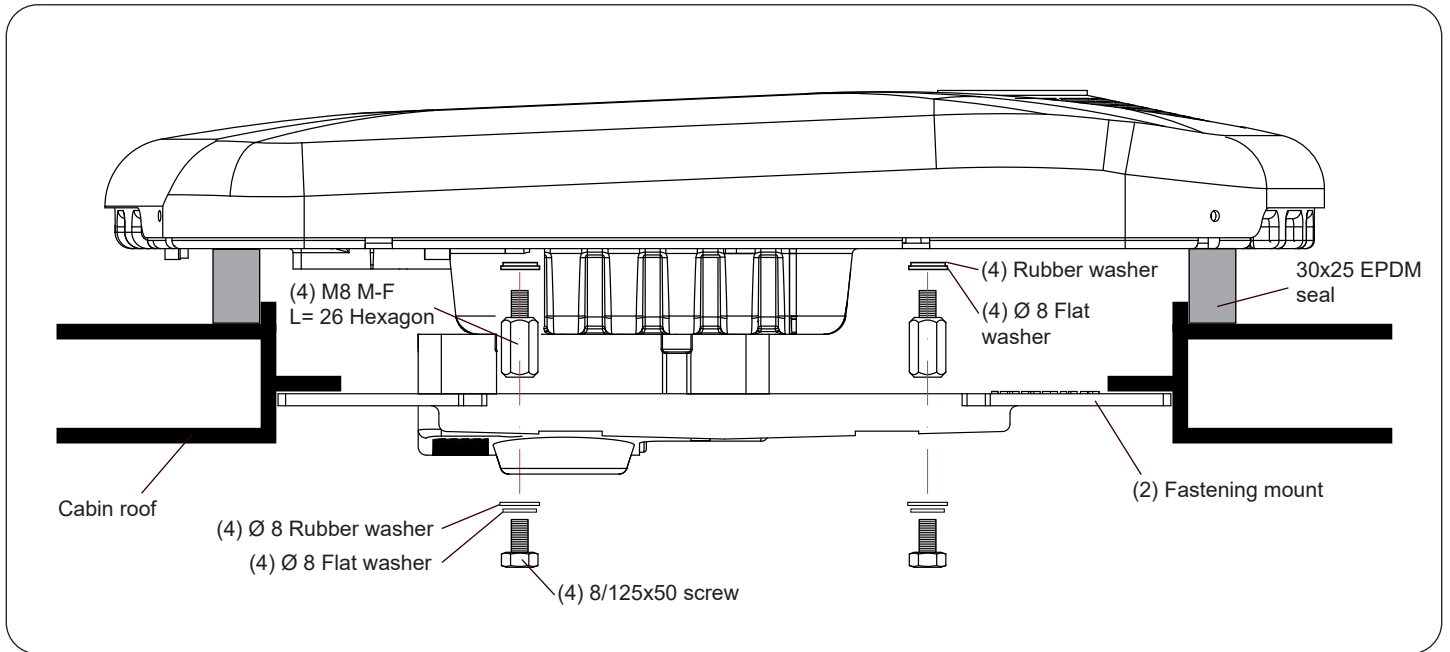

Exploded side view through to console attachment

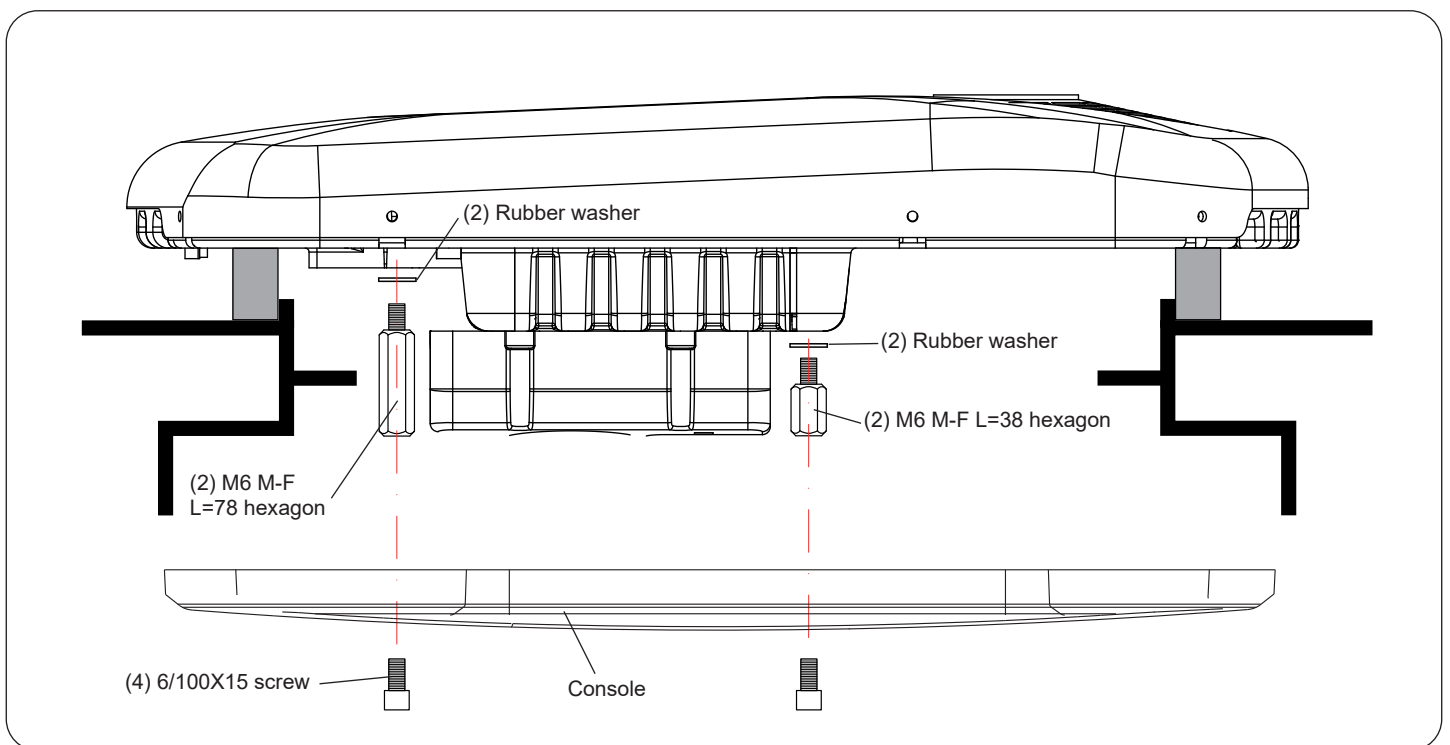

POWER SUPPLY CONNECTION



Caution: Follow the electrical installation guidelines according to the manufacturer's instructions.

1 Connect wiring harness in the unit.

2 Plug in to the original connector of the vehicle.

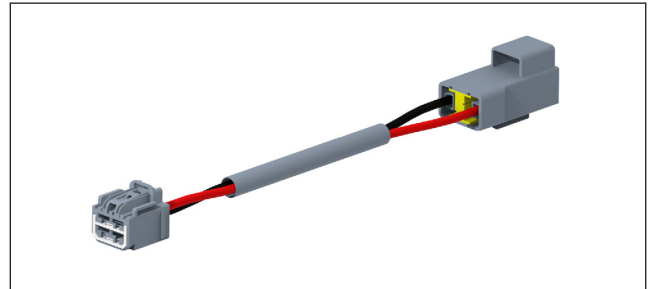

Connect to the original wiring

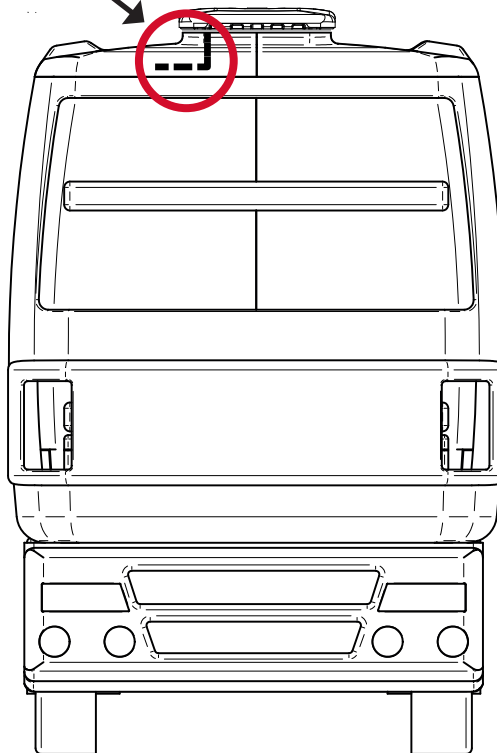

Wiring diagram

⚠ IMPORTANT NOTE!

Take care not to invert polarities when connecting the unit to the power supply; the display does not come on and the unit does not work.

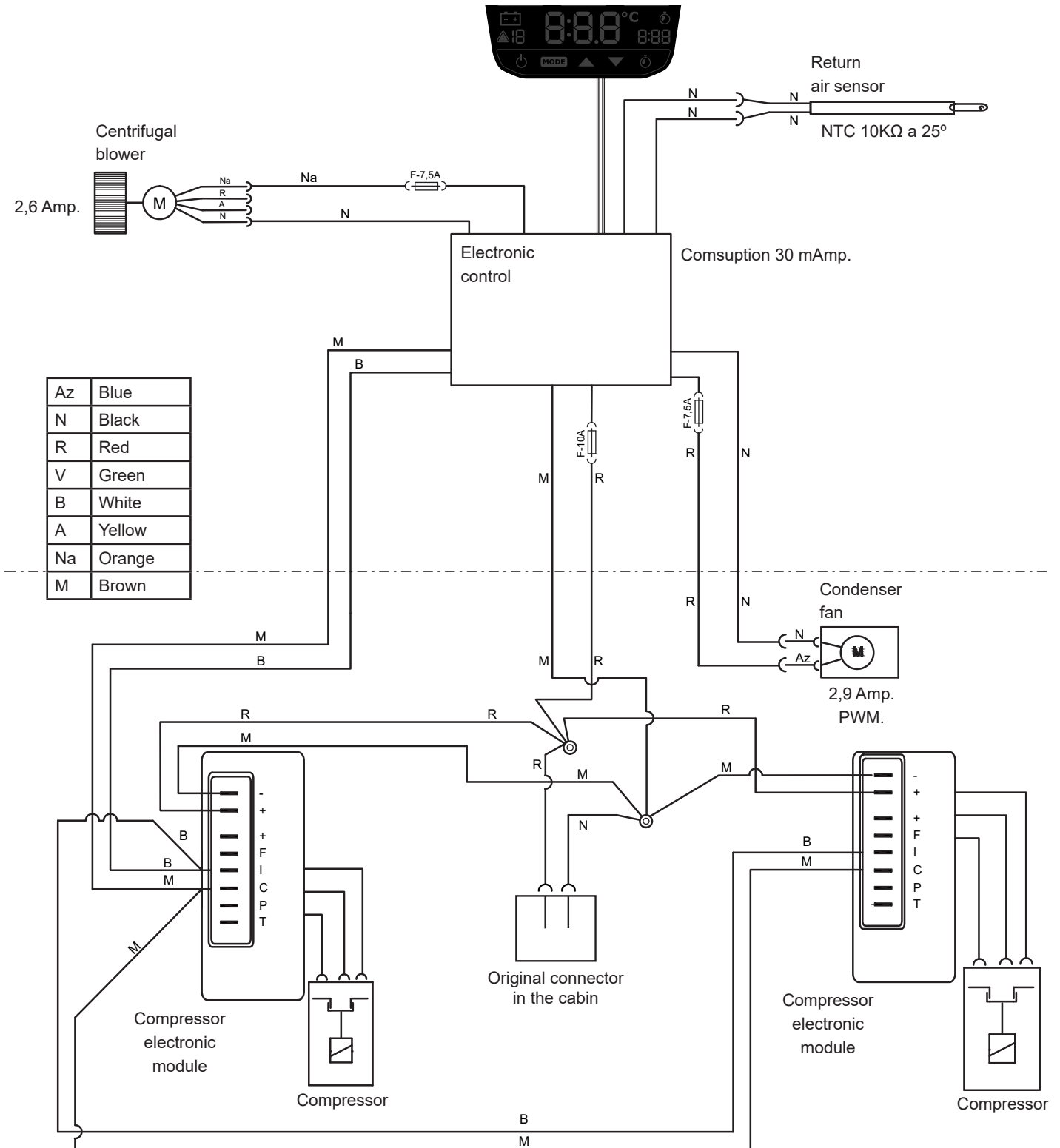

Nous vous remercions de votre achat et de la confiance témoignée à notre gamme de produits. **SLIMFIT** est une unité de climatisation conçue et fabriquée par **Dirna Bergstrom** pour une utilisation dans un véhicule avec le moteur à l'arrêt pendant les périodes de repos à l'ombre et/ou la nuit.

SLIMFIT est conçue avec la technologie la plus avancée pour obtenir des performances efficaces, une consommation réduite de carburant et diminuer les émissions de CO₂ dans l'atmosphère. Grâce à ces particularités, elle est unique sur le marché de la climatisation pour véhicules.



Veillez lire attentivement ce document avant d'installer le produit. Conservez ce document pour toute référence ultérieure.

La documentation d'origine a été rédigée en espagnol, les autres langues sont donc des traductions.

Vous avez à votre disposition tous les manuels des produits dans leurs versions numériques (PDF) sur <https://www.dirna.com/>

Toute opération de vente ou de garantie est soumise à nos conditions générales de vente dans leur version la plus à jour, publiée sur notre site Web <https://www.dirna.com/>

Explication des symboles



- **Mise en garde** : Avis de sécurité informant d'une situation qui, si elle n'est pas évitée, pourrait conduire à des blessures graves ou la mort.



- **Danger** : Risque de coupure. Signale une situation qui pourrait conduire à une coupure.



- **Danger** : Risque d'électrocution. Signale une situation qui pourrait conduire à une électrocution.



- **Avertissement** : Avis de sécurité informant d'une situation qui, si elle n'est pas évitée, pourrait entraîner des dommages matériels (équipement ou autre).



- **Information** : Information complémentaire sur l'installation ou la manipulation du produit.



- **Fragile** : Indique une situation dans laquelle il faut procéder avec précaution afin de ne pas endommager l'équipement ou d'autre matériel.



Explication des responsabilités

- **Dirna Bergstrom** décline toute responsabilité en termes de dommages causés dans les cas suivants :

- Dommages au produit dus à des influences mécaniques et à des surtensions.
- Modifications apportées à l'équipement sans le consentement exprès du fabricant.
- Utilisation de l'équipement à des fins non décrites dans ce document.
- Manipulation ou installation inappropriée de l'équipement.

- La manipulation des circuits de gaz réfrigérant sans autorisation expresse du fabricant est interdite.



Mises en garde au cours du montage

- L'installation, la réparation et l'entretien de cet équipement de climatisation ne peuvent être réalisés que par un personnel technique suffisamment formé sur la climatisation des véhicules, les dangers éventuels et les normes applicables.
- Lire attentivement les consignes de montage avant de commencer l'installation de l'équipement. Pendant l'installation, suivre au pied de la lettre les consignes indiquées.
- Débrancher la clé de contact avant de commencer l'installation de l'équipement.
- Débrancher la batterie du véhicule avant de commencer l'installation de l'équipement.
- Installez **SLIMFIT** en toute sécurité afin d'éviter les chutes.
- Utiliser les outils appropriés à chaque opération.
- Pendant l'installation, s'assurer du raccordement des composants électriques en vérifiant leur bon ajustement.
- Si lors de l'installation de l'équipement, les câbles traversent des murs à arêtes vives, utilisez des conduits ou des dispositifs de guidage, afin d'éviter l'endommagement des câbles.
- Si pendant son installation, l'équipement s'incline ou la cabine se rabat avec l'équipement installé dessus, attendez au moins 60 minutes, à compter du moment où l'équipement est à l'horizontale, avant de le mettre en marche.
- Équipement préchargé en gaz réfrigérant r-134a.



- **Avertissement important** : Faites attention lors du raccordement de l'équipement à ne pas inverser les polarités. Si cela se produit, la carte de commande ne s'allumera pas et l'équipement ne se mettra pas en marche.



Outils requis pour le montage

- Jeu de clés Torx.
- Jeu de clés Allen.
- Clé fixe 13, 14, 22.
- Ciseaux.
- Mètre.



Utilisation appropriée du produit

- **SLIMFIT** est une unité de climatisation de toit destinée à être utilisée dans les camions uniquement. Il n'est pas apte pour être installé ou fonctionner sur des machines agricoles ou de construction soumises à des vibrations intenses.
- L'utilisation non conforme à l'usage prévu annule la garantie de l'équipement et exclut la responsabilité du fabricant.
- Si vous n'êtes pas sûr de comment utiliser **SLIMFIT**, consultez le mode d'emploi du produit.
- Si la température dans la cabine de votre véhicule est trop élevée pour le repos, refroidissez d'abord la cabine avec la climatisation de votre véhicule pendant quelques minutes, puis mettez le **SLIMFIT** en marche afin de maintenir une température confortable.



Documentation connexe

- Guide rapide : 1003115344
- Mode d'emploi : 1003148646
- Liste de pièces de rechange : 1003150687
- Diagnostic de pannes : 1003148649

Dirna Bergstrom déclare que l'équipement **SLIMFIT** satisfait aux exigences des Directives CE suivantes, et que les normes et spécifications techniques harmonisées énumérées ci-dessous ont été appliquées :

- Directive CE 2014/53/UE
- Directive CE 2011/65/UE
- Directive CE 2014/30/UE

1 Démontez l'écouille et les éléments de fixation et les remettre au client.

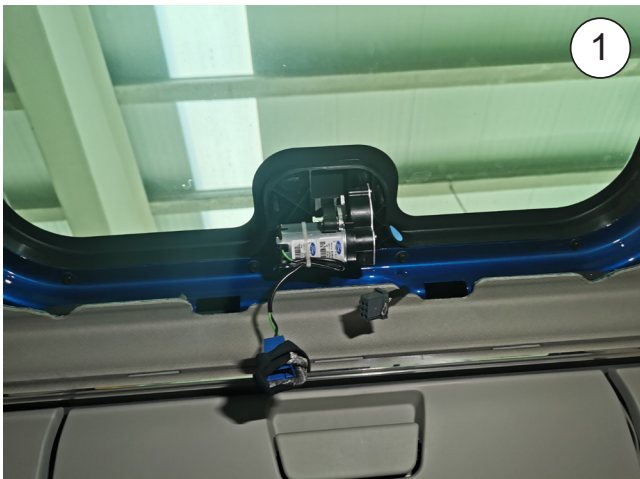

2 Coller le joint EPDM 30x25 autour du creux de l'écoutille (observer le détail pour couper les bords fins de l'union du joint).



! **Attention:** Le joint EPDM doit être collé près du bord de l'espace de la trappe.

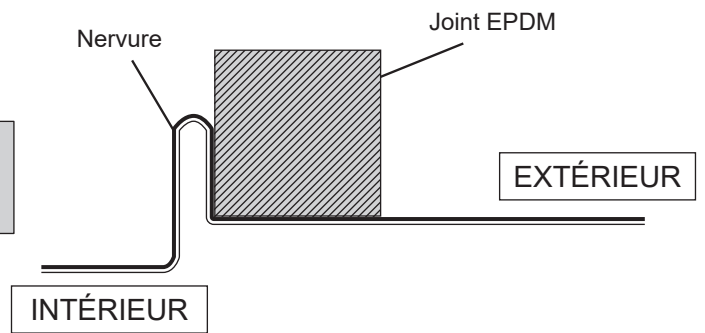

! **COMMENT COUPER LE JOINT EPDM POUR ÉVITER LA FILTRATION D'EAU DANS LA CABINE**

A- Coller le joint et garder 100 mm de papier protecteur de chaque côté.

B- Retirer les deux pièces de papier.

C- Collez en exerçant une pression sur les deux extrémités.

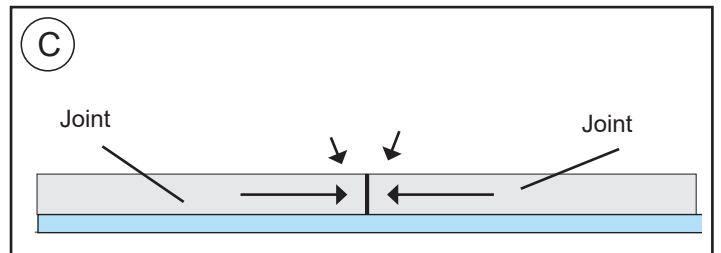
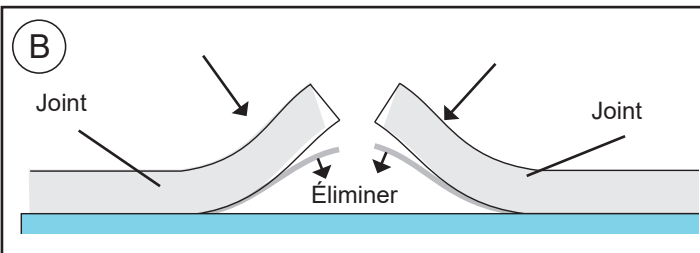
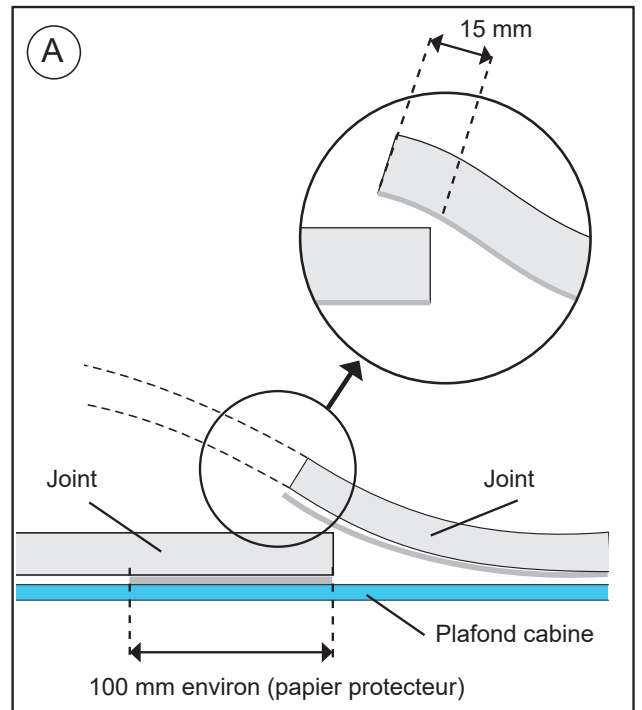

- 3** Positionner l'appareil sur le joint en introduisant le panneau intérieur de distribution dans l'espace de l'écouille.

Attention ! Avant de placer l'équipement sur le creux de l'écouille, il faut vérifier que les sorties d'écoulement ne soient pas bouchées par le joint EPDM.

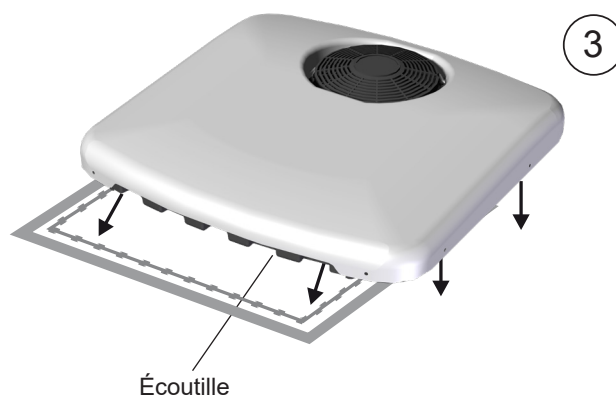

- 4** Visser (4) hexagones M8/125x26 avec une rondelle en caoutchouc, une rondelle plane sur les inserts de la base et serrer avec un couple de serrage de $12,7 \pm 10$ Nm.

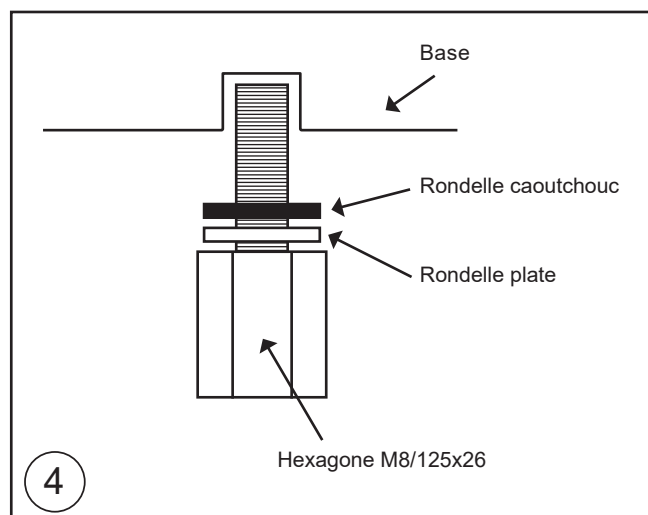

- 5** Placer les supports de fixation avec une rondelle plate, rondelle grower et vis M8/125x50 **sans serrer**.



- 6** Visser (2) hexagones M6 L=38 sur la partie arrière de l'appareil (sens de la marche) avec une rondelle en caoutchouc et serrer avec un couple de serrage de $4,75 \pm 10\%$ Nm.

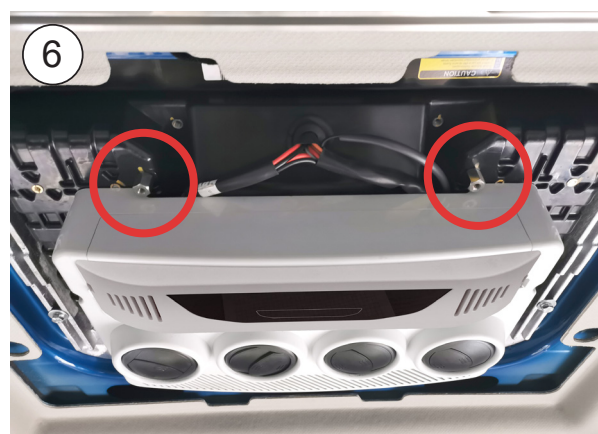

- 7** Visser (2) hexagones M6 L=78 sur la partie avant de l'appareil (sens de la marche) avec une rondelle en caoutchouc et serrer avec un couple de serrage de $4,75 \pm 10\%$ Nm.

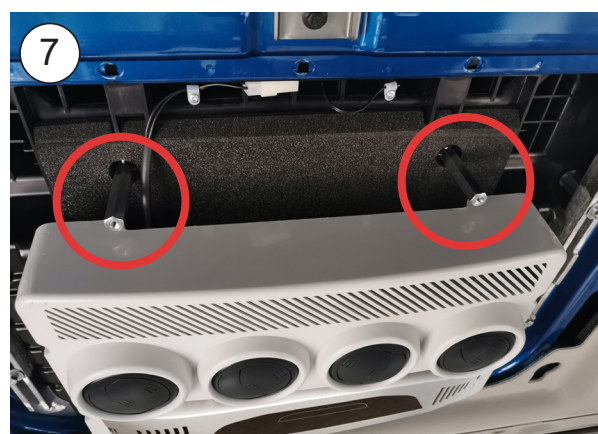

8 Présenter la console et centrer l'équipement.



9 Retirer le supplément console et serrer les vis M8/125x50 jusqu'à buter contre les hexagones pour fixer l'appareil.

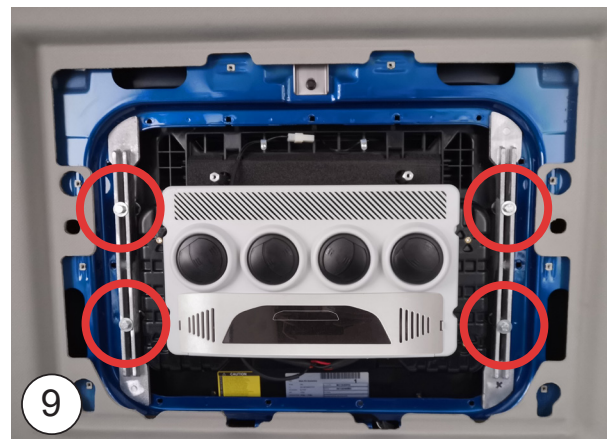

10 Monter la console avec (4) vis M6.



Vue éclatée jusqu'à la fixation des supports

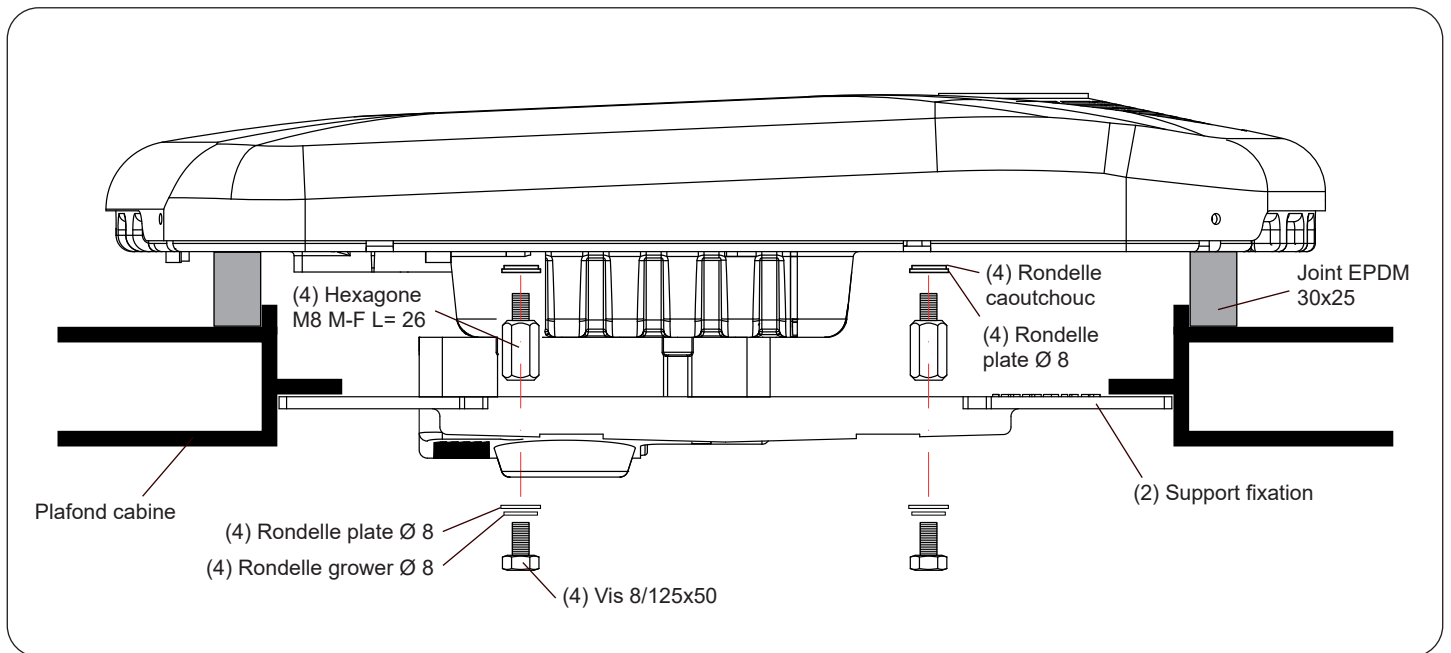

Vue éclatée laterale jusqu'a la fixation des console

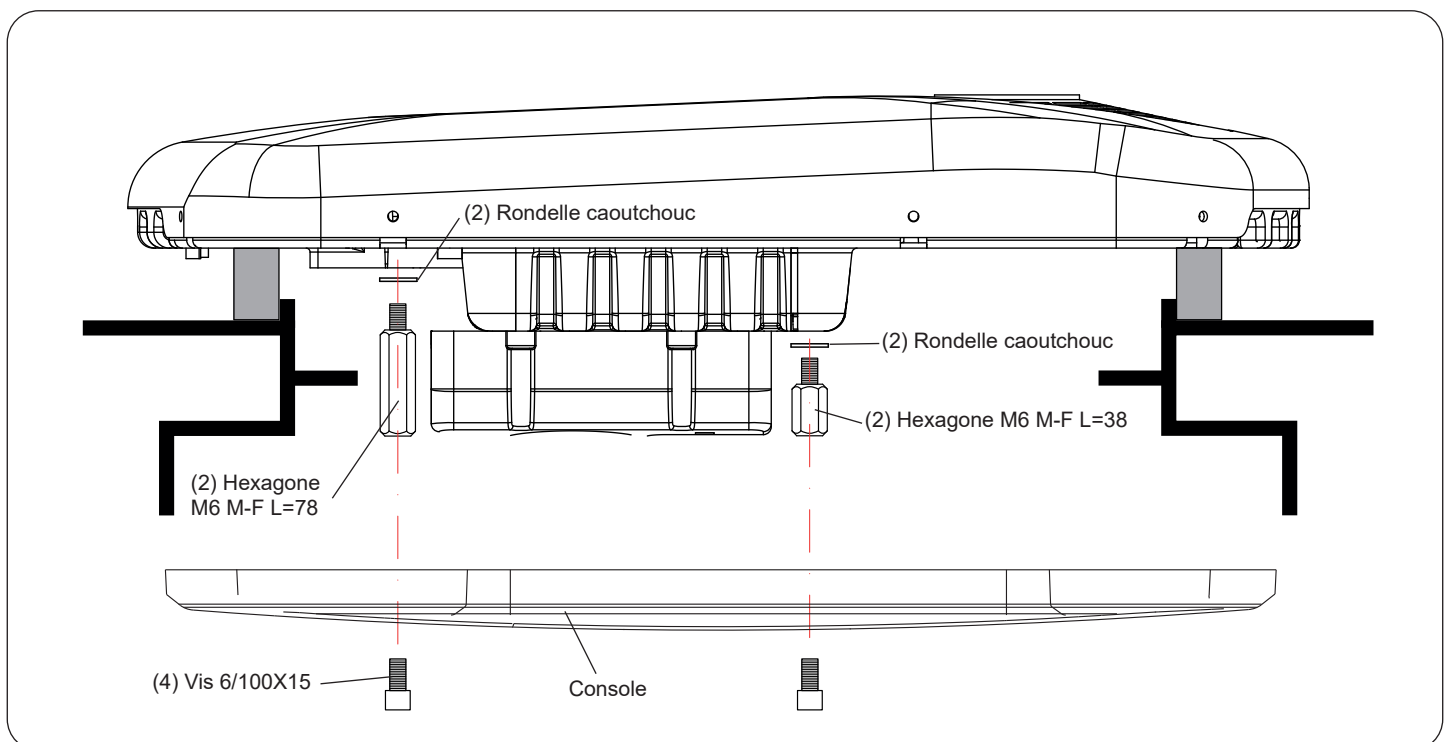

CONNEXION CÂBLAGE D'ALIMENTATION



Attention : Suivez les consignes de l'installation électrique selon les indications du fabricant.

1 Connecter le câblage de raccordement à l'appareil.

2 Connectez avec le connecteur d'origine du véhicule.

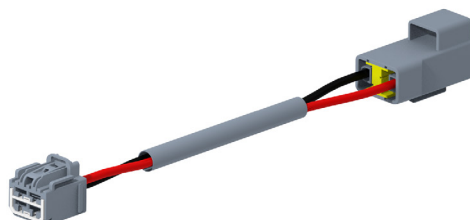

Connecter au câblage d'origine

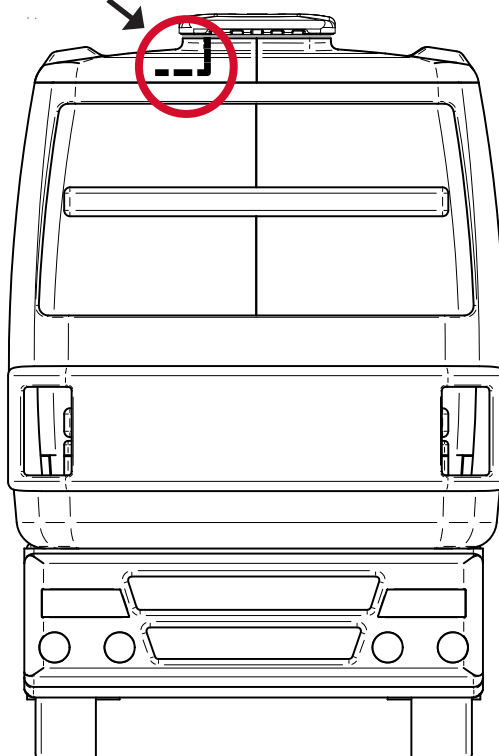

Câblage électrique

AVERTISSEMENT IMPORTANT!

Attention de ne pas inverser les polarités au moment de connecter l'alimentation à l'équipement. Si cela se produisait, la plaque ne s'allumerait pas et l'équipement ne fonctionnerait pas.

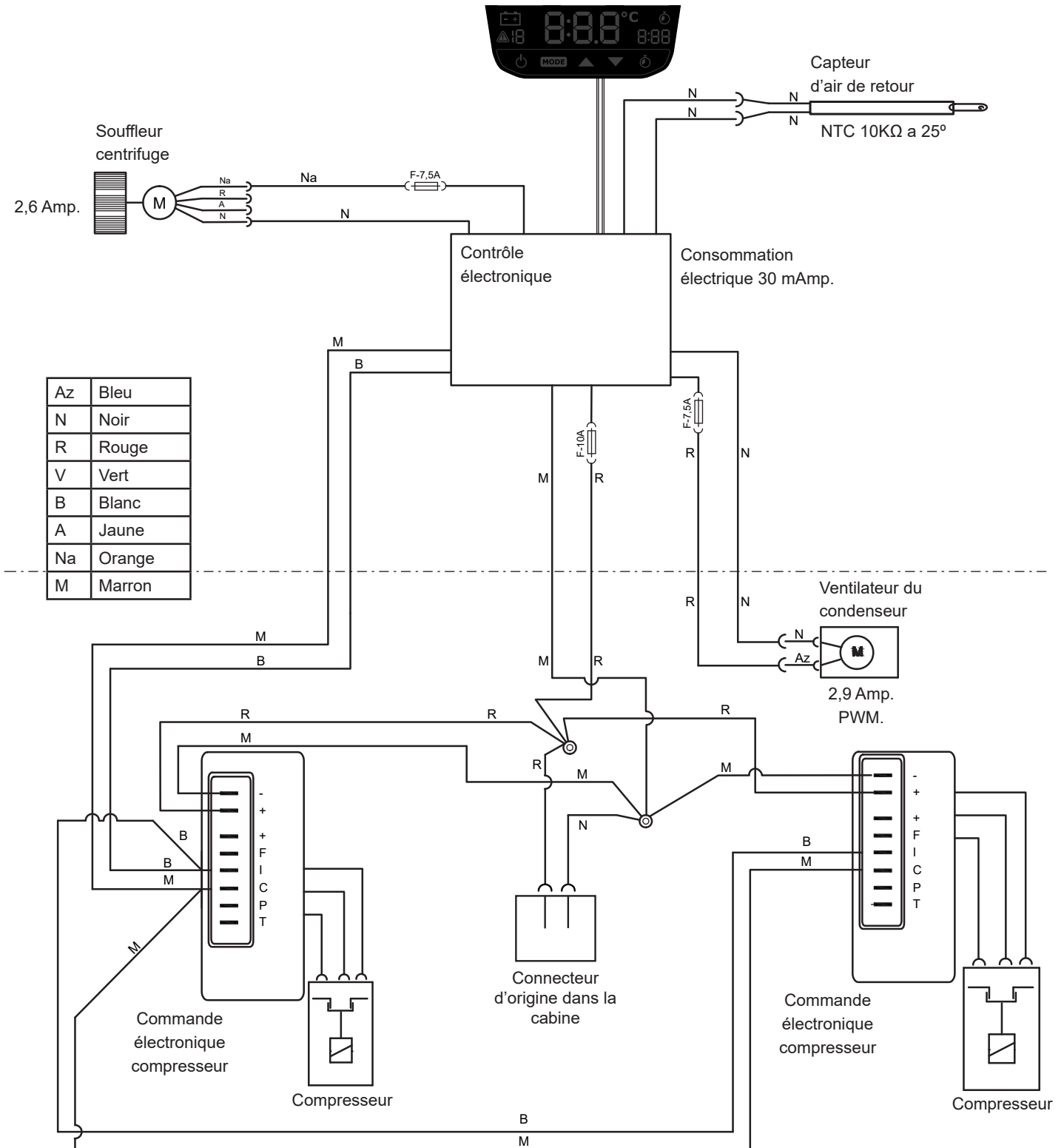

Wir danken Ihnen für Ihren Einkauf und Ihr Vertrauen in unsere Produkte. **SLIMFIT** ist eine von **Dirna Bergstrom** entwickelte und hergestellte Klimaanlage für den Einsatz in einem Kraftfahrzeug, dessen Motor während der Ruhezeiten im Schatten bzw. in der Nacht abgeschaltet ist.

SLIMFIT wurde mit der fortschrittlichsten Technik hergestellt, um eine effiziente Leistung sowie eine Reduzierung des Kraftstoffverbrauchs und der CO₂-Emissionen in die Atmosphäre zu erreichen. Durch diese Eigenschaften ist diese Kfz-Klimaanlage einzigartig auf dem Markt.



Bitte lesen Sie dieses Dokument vor der Installation des Produkts sorgfältig durch und bewahren Sie es zum späteren Nachschlagen auf. Die Originaldokumentation wurde in spanischer Sprache verfasst; bei allen anderen Sprachen handelt es sich um Übersetzungen.

Alle Produktanleitungen sind in digitaler Form (PDF) unter <https://www.dirna.com/> erhältlich.

Für alle Verkäufe und Garantievorgänge gelten unsere allgemeinen Geschäftsbedingungen in ihrer jeweils aktuellen Fassung, die auf unserer Website www.dirna.com veröffentlicht sind.

Verwendete Symbole



- **Achtung:** Sicherheitshinweis, der auf eine Situation hinweist, die, wenn sie nicht vermieden wird, zum Tod oder zu schweren Verletzungen führen kann.



- **Gefahr:** Schnittgefahr. Weist auf eine Situation hin, die zu Schnittverletzungen führen kann.



- **Gefahr:** Stromschlaggefahr. Weist auf eine Situation hin, die zu einem Stromschlag führen kann.



- **Hinweis:** Sicherheitshinweis, der auf eine Situation hinweist, die, wenn sie nicht vermieden wird, zum Schäden am Gerät oder anderen Gegenständen führen kann.



- **Information:** Zusatzinformationen zu Installation oder Handhabung des Produkts.



- **Zerbrechlich:** Weist auf eine Situation hin, in der Vorsicht geboten ist, um Schäden am Gerät und anderen Gegenständen zu vermeiden.



Haftung

- **Dirna Bergstrom** lehnt in den folgenden Fällen jede Haftung für Schäden ab:

- Beschädigung des Produkts durch mechanische Einflüsse und Überspannung.
- Änderungen am Gerät, die ohne ausdrückliche Genehmigung des Herstellers vorgenommen wurden.
- Verwendung des Geräts für Zwecke, die nicht in diesem Dokument beschrieben sind.
- Unsachgemäße Handhabung oder Installation des Geräts.

- Ohne ausdrückliche Genehmigung des Herstellers dürfen keine Eingriffe in die Kältemittelkreisläufe vorgenommen werden.



Warnhinweise hinsichtlich der Montage

- Einbau, Reparatur und Wartung dieser Klimaanlage dürfen nur von Fachpersonal durchgeführt werden, das in Bezug auf Fahrzeugklimatisierung, mögliche Gefahren und geltende Normen ausreichend geschult ist.
- Bitte lesen Sie die Installationsanleitung sorgfältig durch, bevor Sie mit der Installation des Geräts beginnen. Befolgen Sie bei der Installation genau die hier gegebenen Anweisungen.
- Vor der Installation des Geräts den Zündschlüssel ausschalten.
- Vor der Installation des Geräts die Fahrzeugbatterie abklemmen.
- Die **SLIMFIT** sicher anbringen, damit sie nicht herunterfallen kann.
- Für jeden Arbeitsschritt geeignete Werkzeuge benutzen.
- Bei der Installation auf den Anschluss der elektrischen Komponenten achten und prüfen, ob diese richtig sitzen.
- Wenn die Kabel bei der Installation des Geräts entlang scharfkantiger Wände verlaufen, Leerrohre oder Führungen benutzen, um eine Beschädigung der Kabel zu vermeiden.
- Wird das Gerät während der Installation geneigt oder das Fahrerhaus mit montiertem Gerät gekippt, müssen ab dem Zeitpunkt, zu dem das Gerät wieder waagrecht liegt, mindestens 60 Minuten vergehen, bevor es in Betrieb genommen wird.
- Das Gerät ist mit Kältemittel R-134a vorgefüllt.



- **Wichtiger Hinweis:** Beim Anschluss des Geräts darauf achten, dass die Polarität nicht vertauscht wird, da sich sonst die Bedientafel nicht einschaltet und das Gerät nicht funktioniert.



Für die Montage erforderliche Werkzeuge

- Torx-Schraubenschlüssel
- Inbusschraubenschlüssel
- 13er, 14er, 22er Schraubenschlüssel
- Schere
- Metermaß



Bestimmungsgemäße Verwendung

- **SLIMFIT** ist eine auf dem Dach montierte Klimaanlage, die nur für den Einsatz in Lkw geeignet ist. Sie eignet sich nicht für den Einbau und Betrieb in landwirtschaftlichen Maschinen oder Baumaschinen, bei denen starke Schwingungen auftreten.
- Bei nicht bestimmungsgemäßer Verwendung erlischt die Garantie für das Gerät und die Haftung des Herstellers ist ausgeschlossen.
- Wenn Sie hinsichtlich der Verwendung der **SLIMFIT** unsicher sind, schlagen Sie bitte in der Bedienungsanleitung des Produkts nach.
- Wenn die Temperatur im Fahrerhaus Ihres Fahrzeugs zum Ausruhen zu hoch ist, kühlen Sie das Fahrerhaus zunächst einige Minuten lang mit der Klimaanlage Ihres Fahrzeugs ab und lassen Sie dann die **SLIMFIT** laufen, um die Komforttemperatur zu halten.



Zugehörige Dokumente

- Kurzanleitung: 1003115344
- Bedienungsanleitung: 1003148646
- Ersatzteilliste: 1003150687
- Fehlerbehebung: 1003148649

Dirna Bergstrom erklärt, dass das Gerät **SLIMFIT** den Anforderungen der folgenden EG-Richtlinien entspricht und dass die unten aufgeführten harmonisierten Normen und technischen Spezifikationen angewendet wurden:

- Richtlinie 2014/53/EU
- Richtlinie 2011/65/EU
- Richtlinie 2014/30/EU

1 Luke und deren Befestigungselemente ausbauen und diese dem Kunden aushändigen.

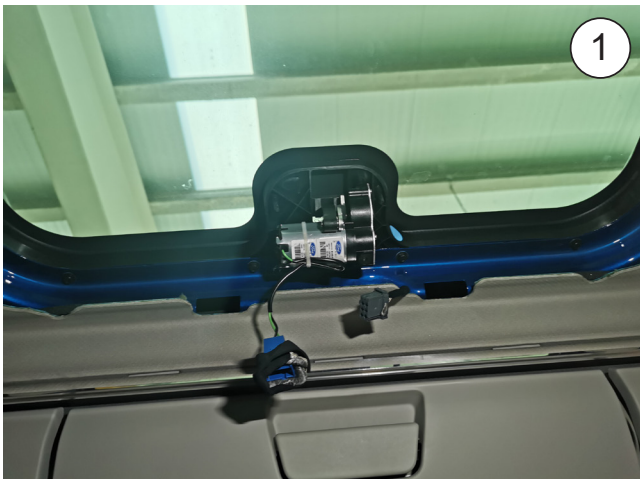
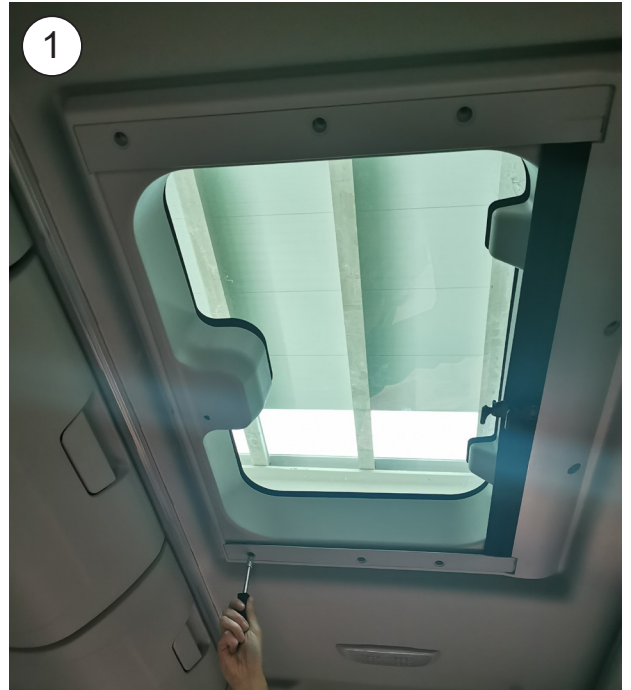

2 EPDM-Dichtung (30x25 mm) um die Lukenausparung herum kleben (siehe Detailzeichnung für das Zurechtschneiden der äußeren Fugenränder der Dichtung).



 **Achtung:** Die EPDM-Dichtung muss am Vorsprung der Lukenausparung angeklebt sein.

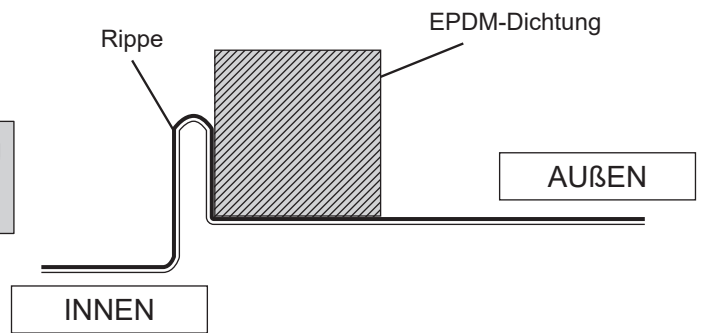

 **WIE DIE EPDM-DICHTUNG GESCHNITTEN A WIRD, UM FILTRATIONEN IN DER KABINE ZU VERMEIDEN**

- A- Dichtung aufkleben und dabei einen Papierschutz von 100 mm auf jeder Seite beibehalten.
- B- Die zwei Papierstücke entfernen.
- C- Unter Anpressen beider Enden aufkleben.

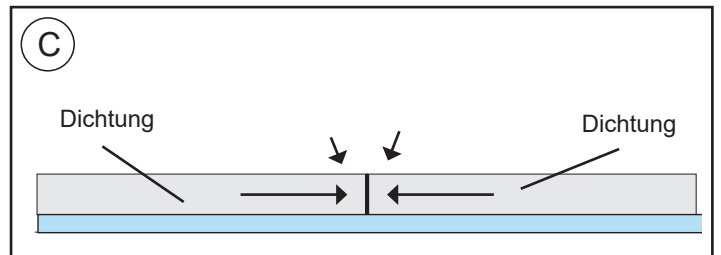
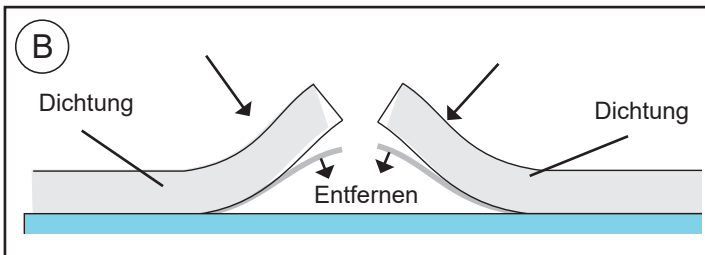
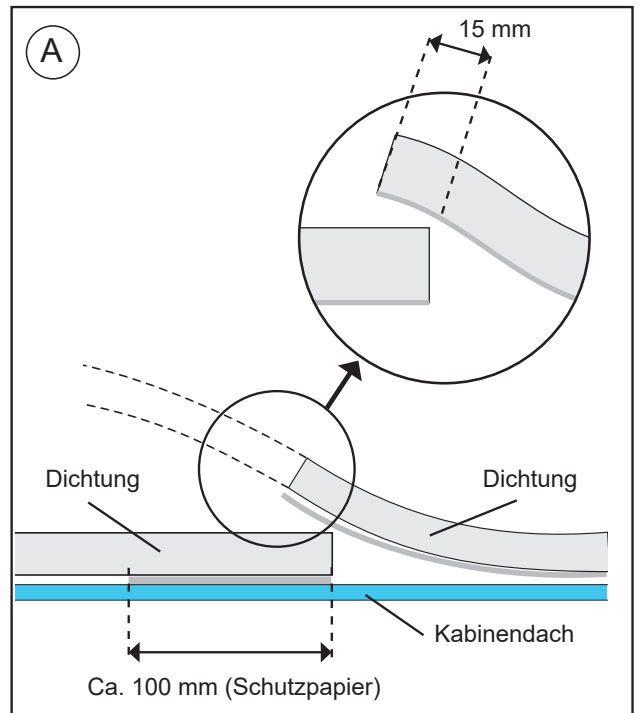

3 Anlage auf die Dichtung legen und die innere Luftverteiltertafel durch die Lukeöffnung stecken.

Achtung! Beim Auflegen des Geräts auf die Lukeausparung darauf achten, dass die Entwässerungsausgänge nicht von der EPDM-Dichtung zusammengedrückt werden.

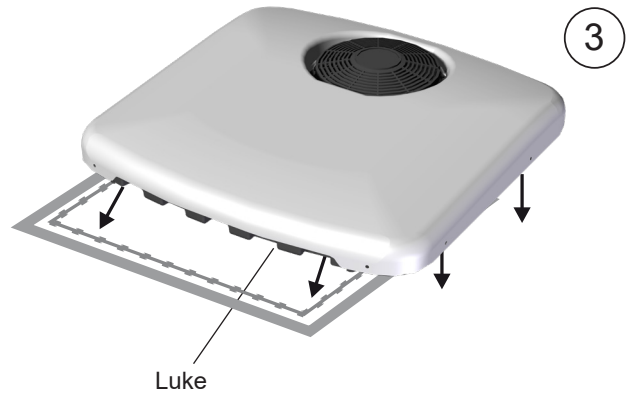

4 (4) Sechskant-Verbindungsmuttern M8/125x26 mit Gummi-Unterlegscheibe und Flachscheibe in die Einsätze der Grundplatte einschrauben und mit einem Anzugsmoment von $12,7 \pm 10$ Nm anziehen.

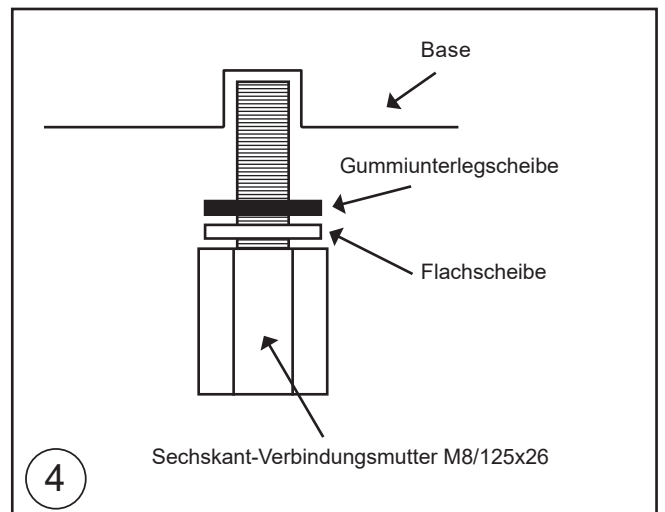
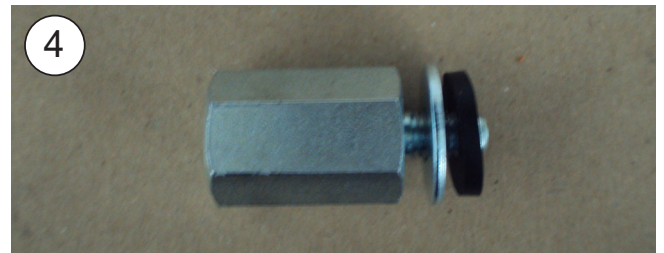
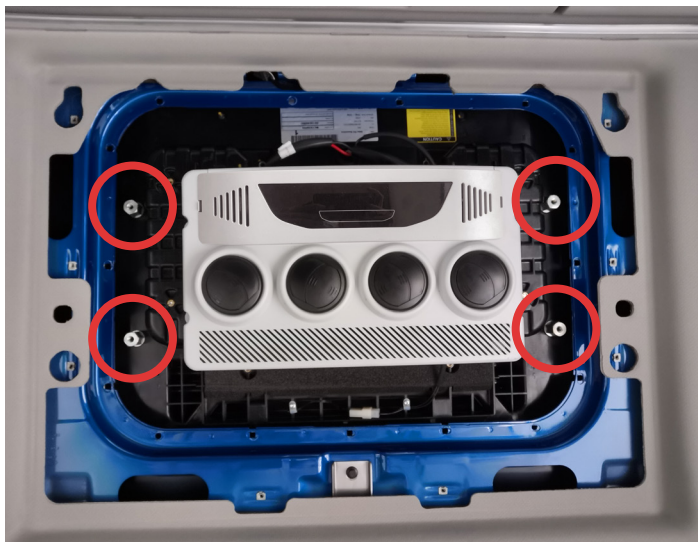

- 5** Befestigungshalterungen mit Flachscheibe, Grower-Scheibe und Schraube M8/125x50 einsetzen ohne anzuziehen.



- 6** (2) Sechskant-Abstandshalter M6 L=38 am hinteren Teil des Geräts (Fahrtrichtung) mit Gummi-Unterlegscheibe einschrauben und auf $4,75 \pm 10\%$ Nm anziehen.

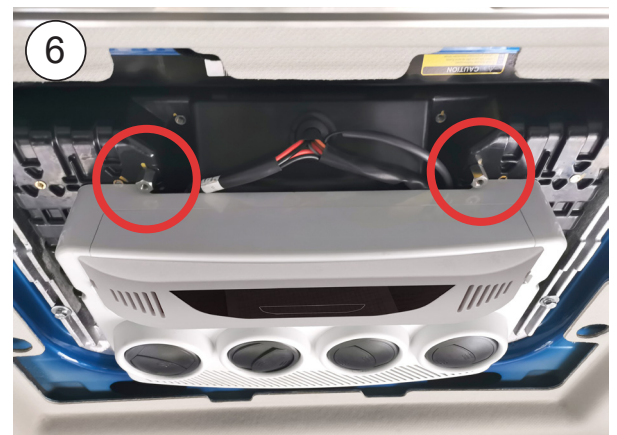

- 7** (2) Sechskant-Abstandshalter M6 L=78 am vorderen Teil des Geräts (Fahrtrichtung) mit Gummi-Unterlegscheibe einschrauben und auf $4,75 \pm 10\%$ Nm anziehen.

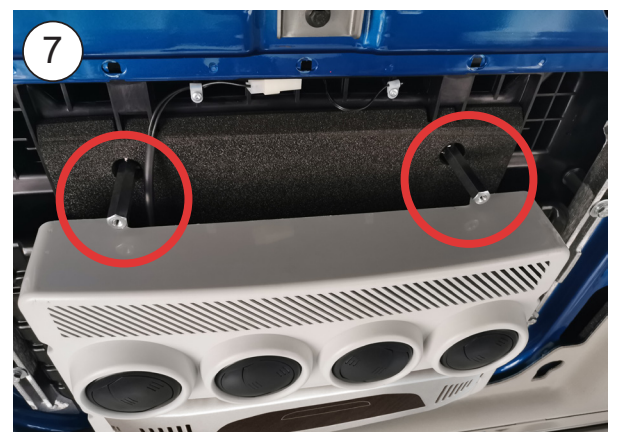

8 Konsole auflegen und Gerät zentrieren.



9 Konsolenergänzung abnehmen und Schrauben M8/125x50 bis zum Anschlag an die Sechskant-Abstandshalter anziehen, um das Gerät zu befestigen.

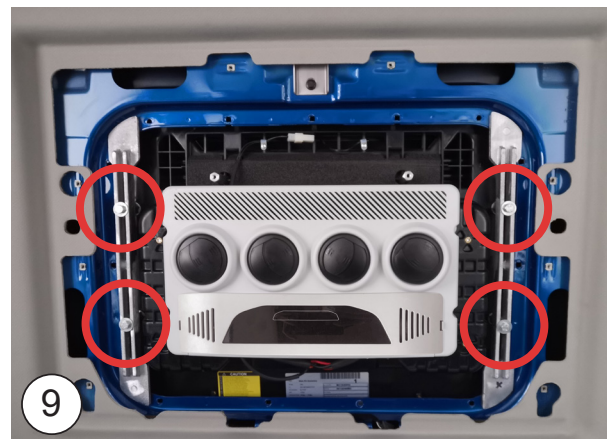

10 Konsole mit (4) Schrauben M6 montieren.



Explosionsansicht bis zur befestigung der halterungen

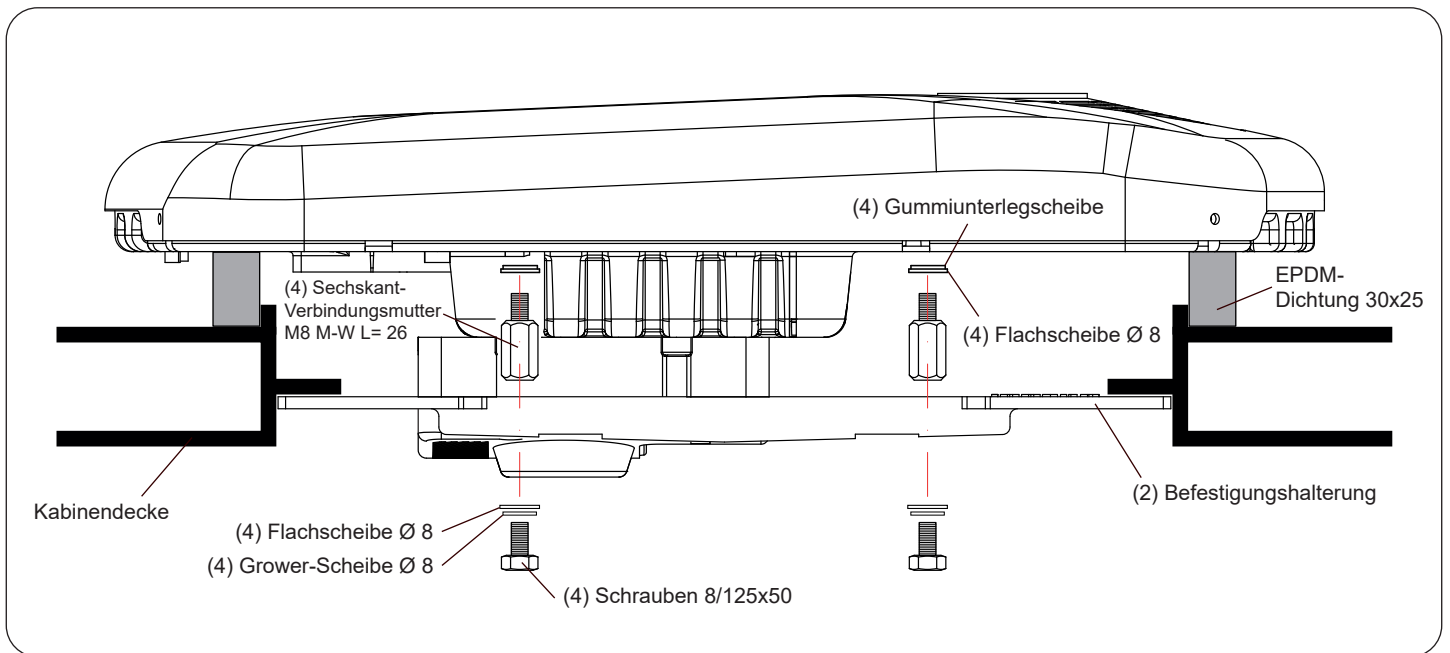

Seitliche explosionsansicht bis zur befestigung der konsolen

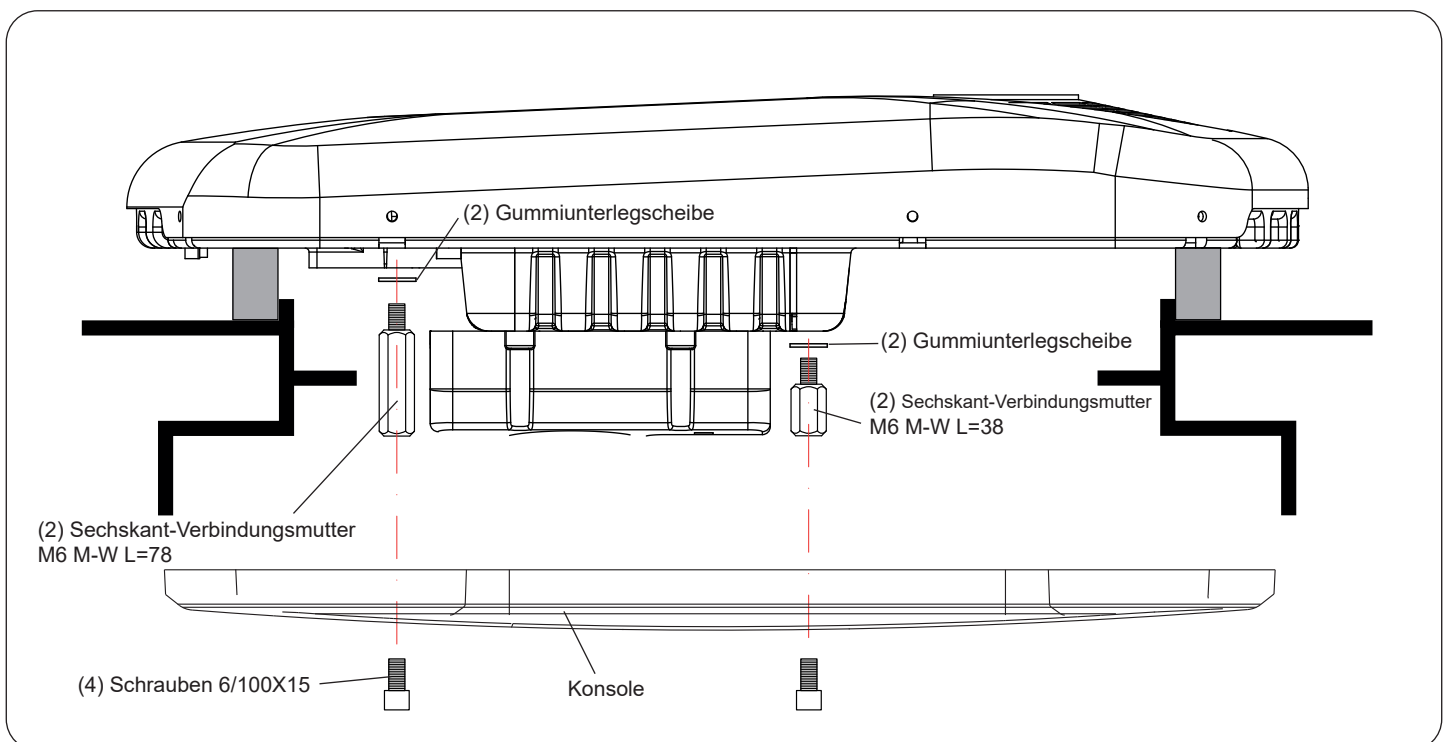

ANSCHLUSS DES NETZKABELS



Achtung: Herstellerhinweise bezüglich der elektrischen Installation beachten.

1 Adapterkabel am Gerät anschließen.

2 Adapterkabel an den Originalstecker des Fahrzeugs anschließen.

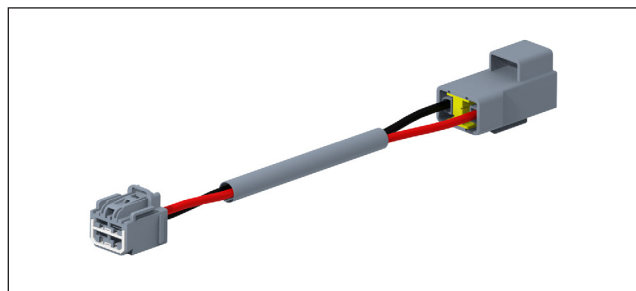

An die Originalverkabelung anschließen

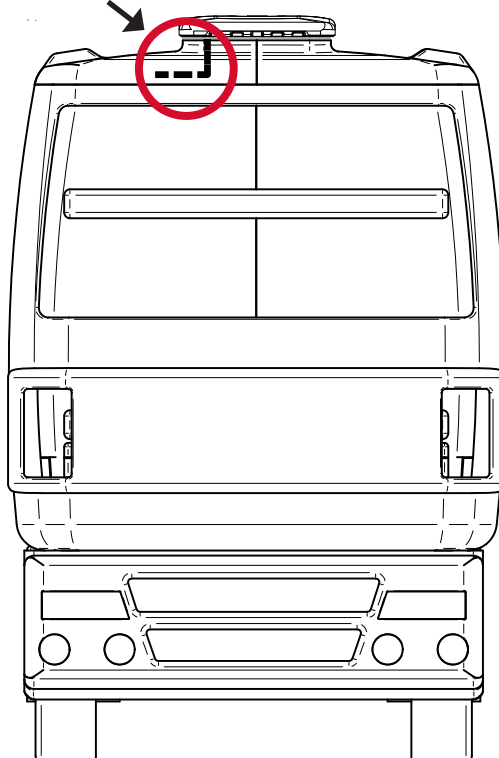

Elektrische Verkabelung

⚠ WICHTIGER WARNHINWEIS!

Darauf achten, dass die Polaritäten beim Anschluss der Stromversorgung an das Gerät nicht vertauscht werden. Ist dies der Fall, schaltet sich die Elektroniktafel nicht ein und das Gerät funktioniert nicht.

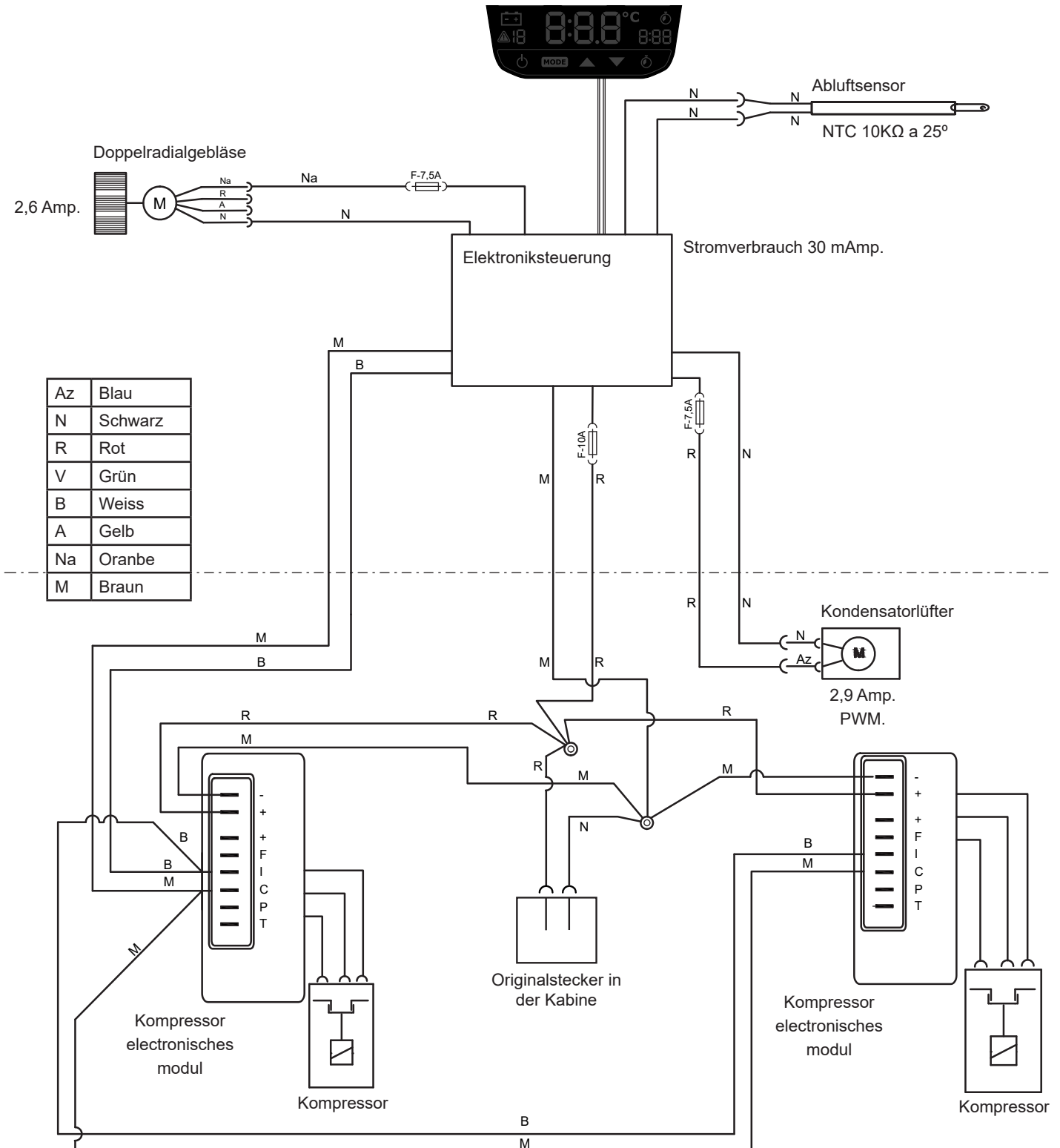

Grazie per l'acquisto e per la fiducia riposta nella nostra gamma di prodotti. **SLIMFIT** è un impianto di aria condizionata progettato e prodotto da **Dirna Bergstrom** per essere usato con il motore del veicolo fermo durante i periodi di sosta all'ombra e/o di notte.

SLIMFIT è progettato con la tecnologia più avanzata per ottenere ottime performance e ridurre i consumi di combustibile e le emissioni di CO₂ in atmosfera. Proprio grazie a queste caratteristiche, è unico nel mercato dell'aria condizionata per veicoli.



Leggere attentamente questo documento prima di installare il prodotto. Conservare questo documento con cura per poterlo consultare in futuro. La documentazione originale è stata stilata in spagnolo, perciò le altre lingue sono traduzioni.

Tutti i manuali del prodotto sono disponibili in versione digitale (PDF) su <https://www.dirna.com/>

La vendita e la garanzia sono disciplinate dalla versione più aggiornata delle nostre condizioni generali di vendita, pubblicata sul nostro sito web <https://www.dirna.com/>

Spiegazione dei simboli



- **Avvertenza:** Avvertenza di sicurezza riguardo a una situazione che, se non venisse evitata, potrebbe provocare gravi lesioni anche mortali.



- **Pericolo:** Rischio di taglio. Segnala una situazione che potrebbe provocare una lesione da taglio.



- **Pericolo:** Rischio di folgorazione. Segnala una situazione che potrebbe provocare una lesione da folgorazione.



- **Avviso:** Avviso di sicurezza riguardo a una situazione che, se non venisse evitata, potrebbe provocare danni all'impianto o ad altri materiali.



- **Informazioni:** Ulteriori informazioni sull'installazione o sulla gestione del prodotto.



- **Fragile:** Indica una situazione in cui si deve procedere con attenzione per non causare danni all'impianto e ad altri materiali.



Esclusione di responsabilità

- **Dirna Bergstrom** declina ogni responsabilità per eventuali danni causati dai casi seguenti:

- Danni al prodotto provocati da sollecitazioni meccaniche e sovratensioni.
 - Modifiche effettuate sull'impianto senza esplicita autorizzazione del costruttore.
 - Uso l'impianto per fini diversi da quelli riportati in questo documento.
 - Movimentazione o installazione errata dell'impianto.
- È vietato qualsiasi intervento sui circuiti del gas refrigerante senza esplicita autorizzazione del costruttore.



Avvertenze durante il montaggio

- L'installazione, la riparazione e la manutenzione di questo impianto di aria condizionata possono essere eseguite esclusivamente da personale tecnico in possesso della formazione necessaria nel campo dell'aria condizionata per veicoli, eventuali pericoli e norme applicabili.
- Leggere attentamente le istruzioni di montaggio prima di iniziare l'installazione dell'impianto. Durante l'installazione, seguire alla lettera le istruzioni indicate.
- Disinserire la chiave di avviamento prima di iniziare l'installazione dell'impianto.
- Disinserire la batteria del veicolo prima di cominciare l'installazione dell'impianto.
- Installare **SLIMFIT** in modo sicuro per evitare cadute.
- Usare gli attrezzi più adatti per ogni operazione.
- Durante l'installazione, assicurare la connessione dei componenti elettrici, verificandone il corretto inserimento.
- Se nell'installazione dell'impianto i cablaggi attraversano pareti con bordi affilati, proteggere adeguatamente i cavi con guaine o passacavi per evitarne il danneggiamento.
- Se durante l'installazione l'impianto viene inclinato o si ribalta la cabina con l'impianto installato, prima di avviarlo occorre attendere almeno 60 minuti dal momento in cui l'impianto è di nuovo in posizione orizzontale.
- Dispositivo precaricato con gas refrigerante R-134a.



- **Avvertenza importante:** quando si collega l'impianto, fare attenzione a non invertire le polarità. Se ciò dovesse succedere, il quadro comandi non si accende e l'impianto non si avvia.



Attrezzi necessari per il montaggio

- Kit di chiavi Torx.
- Kit di chiavi Allen.
- Chiave fissa 13, 14, 22.
- Forbici.
- Metro a nastro.



Corretto uso del prodotto

- **SLIMFIT** è un impianto di aria condizionata da installare sul tetto ed è destinato esclusivamente ai camion. Non è adatto a macchinari agricoli, né per l'edilizia soggetti a forti vibrazioni.
- L'uso non conforme a quello previsto comporta l'annullamento della garanzia dell'impianto e l'esclusione di responsabilità da parte del costruttore.
- In caso di incertezze riguardo all'uso di **SLIMFIT**, consultare il manuale dell'utente del prodotto.
- Se la temperatura nella cabina del veicolo è molto elevata per un riposo confortevole, raffreddare la cabina con l'aria condizionata del veicolo per qualche minuto e quindi avviare **SLIMFIT** per mantenere la temperatura di comfort.



Documenti correlati

- Guida rapida: 1003115344
- Manuale dell'utente: 1003148646
- Elenco dei pezzi di ricambio: 1003150687
- Diagnosi dei guasti: 1003148649

Dirna Bergstrom dichiara che l'impianto **SLIMFIT** soddisfa i requisiti delle seguenti direttive CE e che sono state applicate le norme e le specifiche tecniche armonizzate riportate di seguito:

- Direttiva CE 2014/53/EU
- Direttiva CE 2011/65/EU
- Direttiva CE 2014/30/EU

1 Smontare il coperchio del tettuccio apribile e gli elementi di fissaggio e consegnarli al cliente.

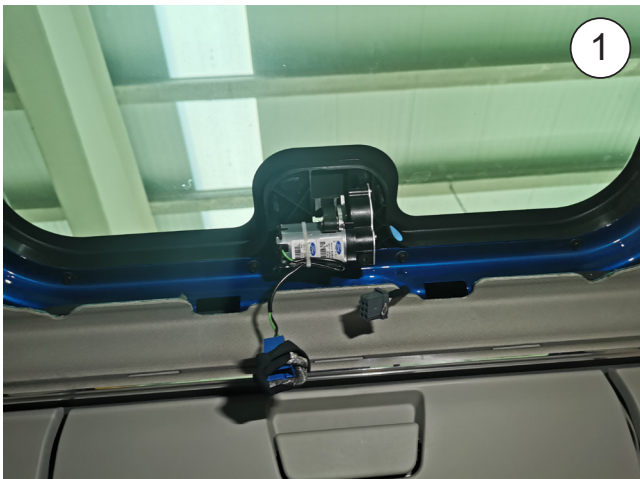

2 Incollare la guarnizione EPDM 30x25 intorno al vano del tettuccio apribile (vedi il particolare per tagliare i bordi finali di attacco della guarnizione).



⚠ **Attenzione:** Incollare la guarnizione EPDM accanto alla sporgenza del vano del tettuccio apribile.

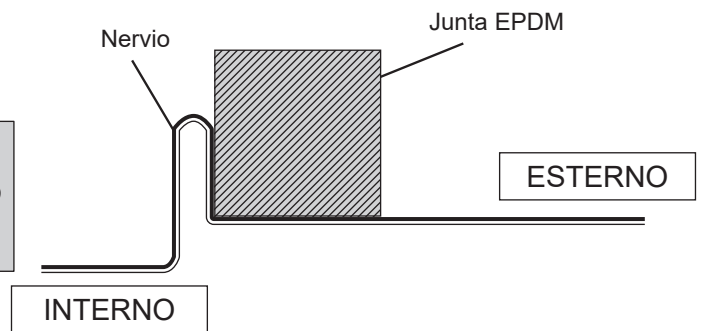

⚠ **INCOLLARE LA GUARNIZIONE EPDM INTORNO A AL FORO DELL'OBLÒ (VEDI PARTICOLARE PER TAGLIARE I BORDI)**

A- Incollare la guarnizione mantenendo una protezione di carta di 100 mm su ogni lato.

B- Rimuovere i due pezzi di carta.

C- Incollare premendo su entrambe le estremità.

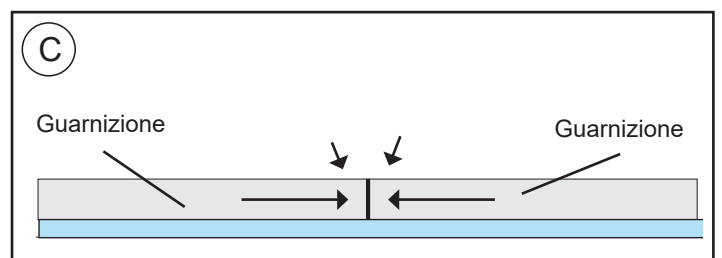
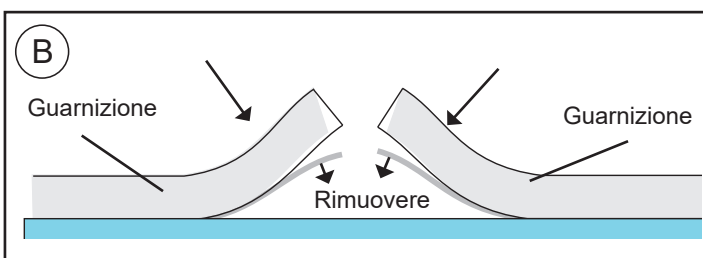
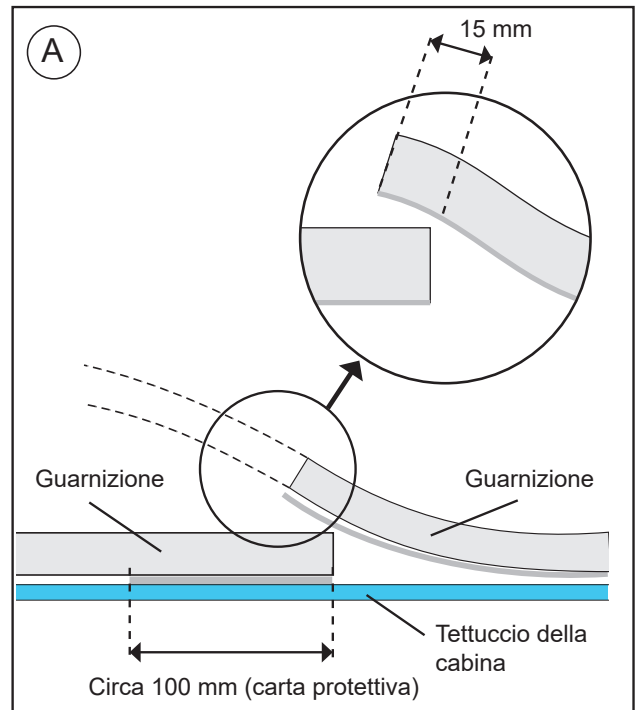

- 3** Sistemare l'impianto sulla guarnizione inserendo il pannello interno di distribuzione nel vano del tettuccio apribile.

Attenzione! Quando si sistema l'impianto sul vano del tettuccio apribile, verificare che le uscite di scarico non siano ostruite dalla guarnizione EPDM.

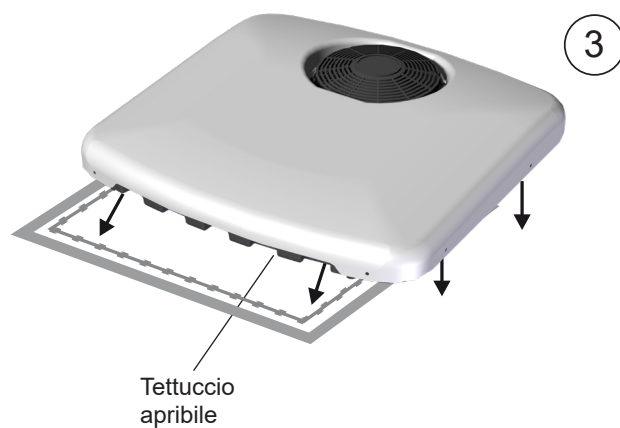

- 4** Avvitare (4) perni esagonali M8/125x26 con rondella di gomma e rondella piana sugli inserti della base e stringere con una coppia di serraggio di 12,7±10 Nm.

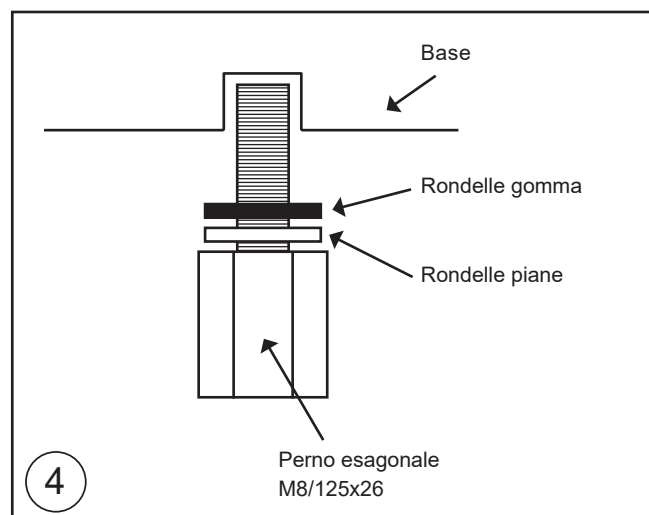
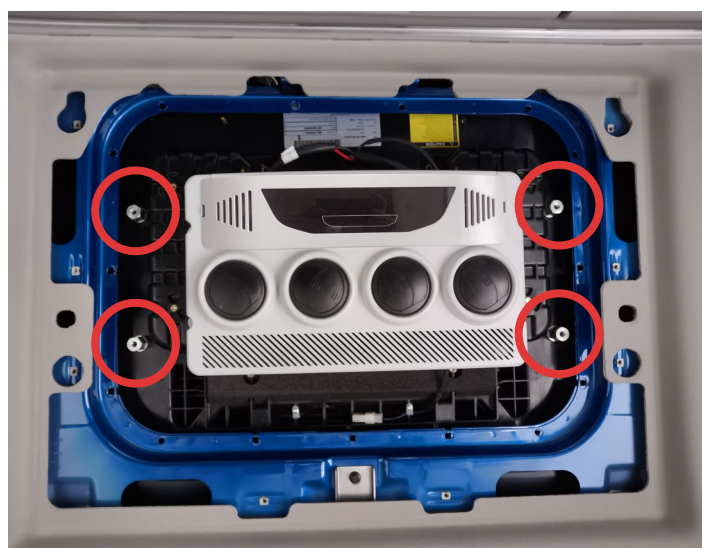

- 5** Inserire i supporti di fissaggio con rondella piana, rondella grower e vite M8/125x50, **senza stringere**.



- 6** Avvitare (2) perni esagonali M6 L=38 nella parte posteriore dell'impianto (senso di marcia) con la rondella di gomma e stringere con una coppia di serraggio di $4,75 \pm 10\%$ Nm.

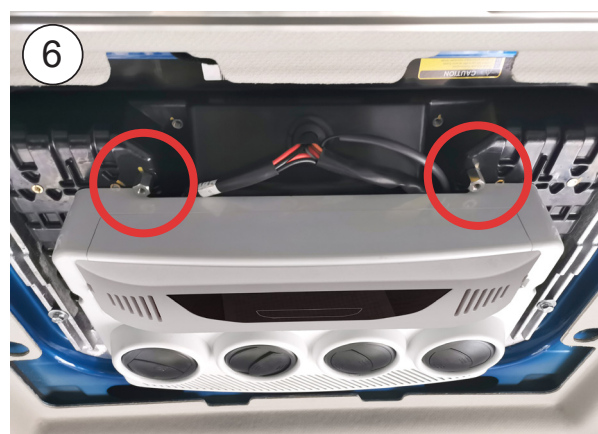

- 7** Avvitare (2) perni esagonali M6 L=78 nella parte anteriore dell'impianto (senso di marcia) con la rondella di gomma e stringere con una coppia di serraggio di $4,75 \pm 10\%$ Nm.

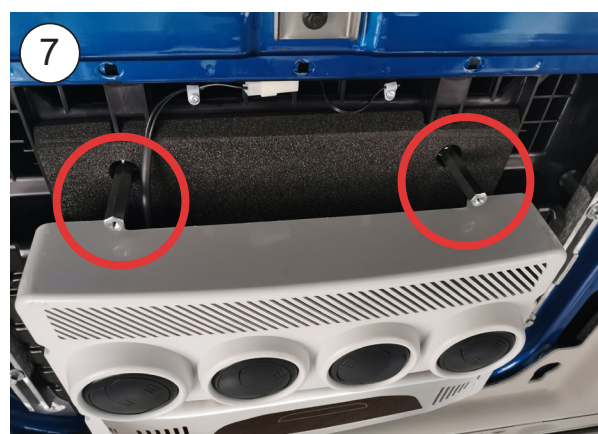

- 8** Sistemare provvisoriamente la console e centrare l'impianto.



- 9** Rimuovere il telaio della console e stringere le viti M8/125x50 fino a battuta con i perni esagonali per fissare l'impianto.

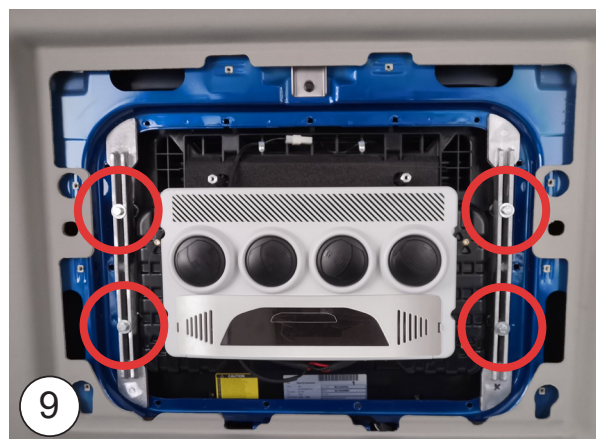

- 10** Montare la console con (4) viti M6.



Esploso fino al fissaggio dei supporti

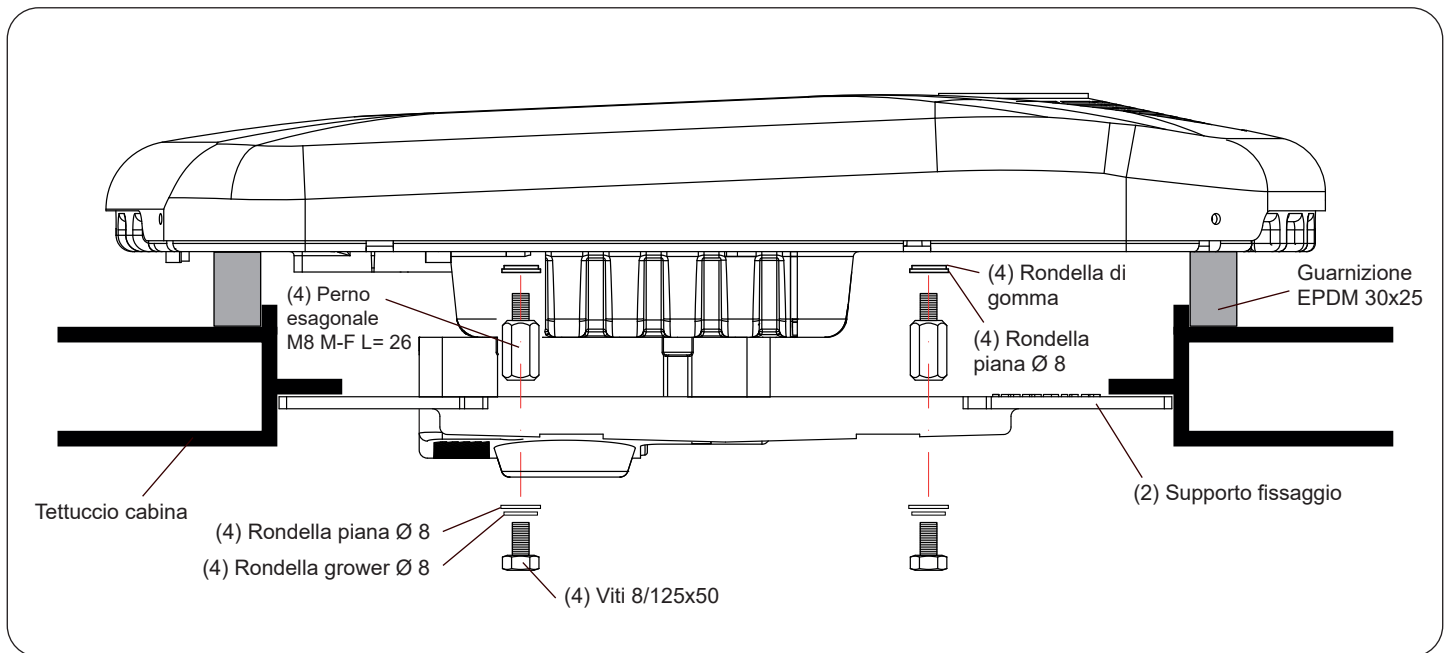

Esploso laterale fino al fissaggio delle console

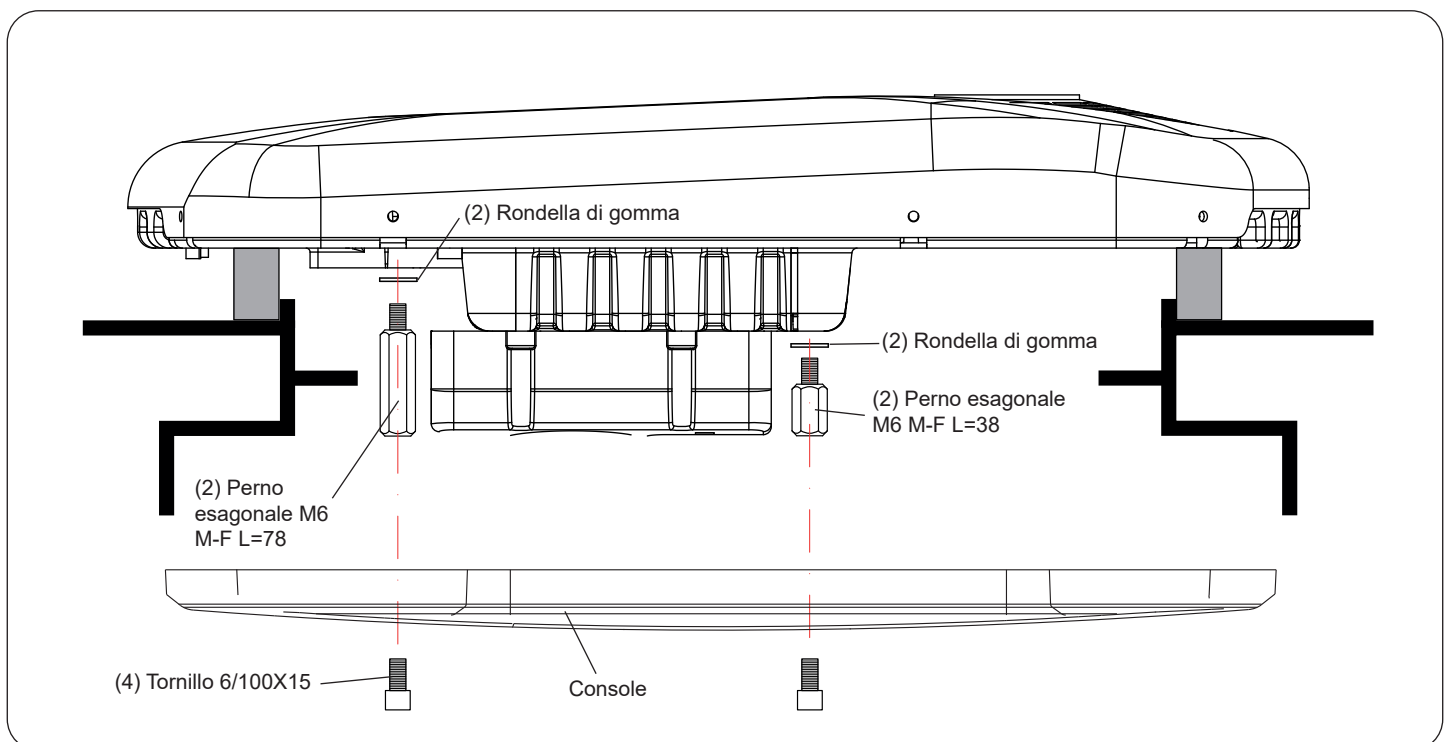

CONNESSIONE CABLAGGIO DI ALIMENTAZIONE



Attenzione: Seguire le linee guida per l'installazione elettrica indicate dal costruttore.

1 Collegare il cablaggio dei ponticelli all'apparecchiatura.

2 Collegare con il connettore originale del veicolo.

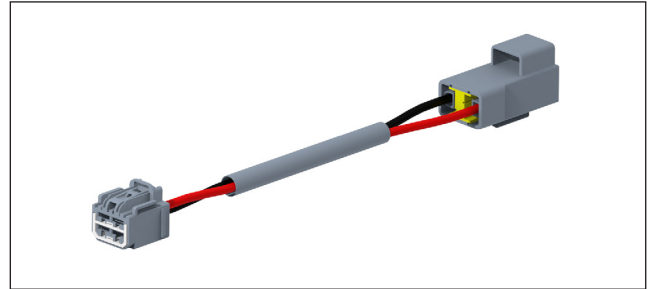

Collegare al cablaggio originale

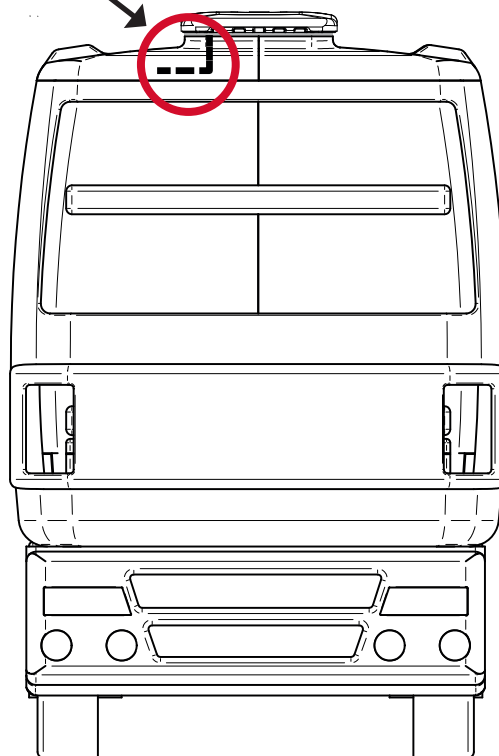

Cablaggio elettrico

⚠ AVVISO IMPORTANTE!

Fare attenzione a non invertire le polarità quando si esegue il collegamento dell'impianto. Infatti, in tal caso il quadro comandi non si accende e l'impianto non funziona.

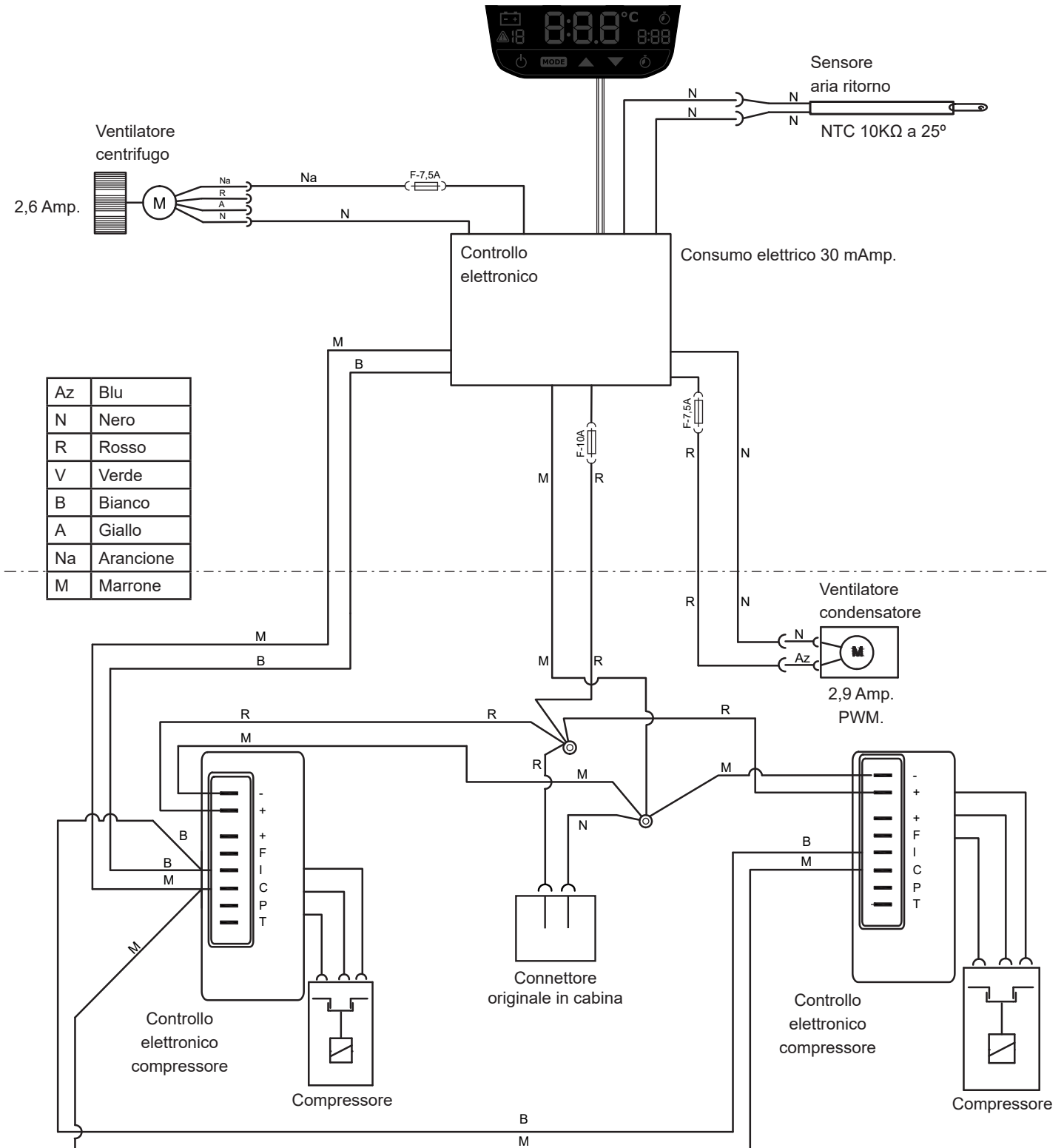



Francisco Alonso, 6
28806 Alcalá de Henares, Madrid
SPAIN

Ed:	24/08/2022
Md:	

Contact	Phone	Fax	E-Mail
Sales (Ventas Internacional)	+34 91 8770510	+34 91 8771158	sales@dirna.bergstrominc.com
Comercial Nacional	+34 91 8775841	+34 91 8836321	ventas@dirna.bergstrominc.com
Orders & Deliveries (Logística internacional)	+34 91 8775846	+34 91 8771158	export@dirna.bergstrominc.com
Orders & Deliveries (Logística nacional)	+34 91 8775840	+34 91 8836321	comercial@dirna.bergstrominc.com
Technical Assistance (Internacional)	+49 511 86679681	+49 511 86679710	technicalassistance@dirna.bergstrominc.com
Technical Assistance (Nacional)	+34 91 8775845	+34 91 883 6321	oblanco@dirna.bergstrominc.com

www.dirna.com

	ATENCIÓN:	Bergstrom se reserva el derecho de efectuar modificaciones en cualquier momento de los datos contenidos en esta publicación, por razones técnicas o comerciales.
	NOTE:	<i>For technical and commercial reasons, Bergstrom reserves the right to change the data contained in this brochure.</i>
	ATTENTION:	Bergstrom se réserve le droit d'effectuer à tout moment des modifications des données reprises sur cette publication, pour des raisons techniques ou commerciales.
	HIWEIS:	<i>Bergstrom behält sich vor, aus technischen oder kaufmännischen Gründen jederzeit Änderungen der Angaben dieser Veröffentlichung vorzunehmen.</i>
	ATTENZIONE:	Bergstrom si riserva il diritto di effettuare modifiche in qualsiasi momento ai dati contenuti in questa pubblicazione, per motivi tecnici o commerciali.