

bijectool!
green line

DINAMIC 1.1

RENAULT "T"



Instrucciones de Montaje

Mounting Instructions

Instructions de Montage

Montageanweisungen

Istruzioni di Montaggio

ES Spanish

EN English

FR French

GE German

IT Italian

Recomendaciones Para el montaje

- Antes de iniciar el montaje leer las instrucciones y seguirlas durante el proceso de instalación.
- Usar las herramientas adecuadas para cada operación.

Electricidad

- Desconectar la llave de contacto.
- Desconectar la batería antes de empezar el montaje.
- Asegurar el conexionado de los componentes eléctricos, verificando su correcto encaje.

Atención

Si durante el montaje el equipo se inclina ó se abate la cabina con el equipo montado, se deberá esperar un mínimo de 60 minutos, desde que el equipo quede horizontal, antes de ponerlo en marcha.

Documentación relacionada

Instrucciones de montaje	1002435861
Manual del usuario	1002430924
Diagnos de averías	1002430925
Listado de recambios	1002435862

Las indicaciones relativas a posición son:

DERECHA: Lado pasajero
IZQUIERDA: Lado conductor

Par de apriete (N.m)

Rosca	Calidad Acero		Par
	8.8	10.9	
M6/100	10	13	10

Montaje de tuberías

Par de apriete

Tubería	Par de apriete	Herramienta
1/4"	13-15	Llave fija 14 mm
3/8"	15-17	Llave fija 19 mm

Herramientas

Carraca con llave de paso de 10

Destornillador de estrella TOP 10

Llave fija de 10, 11, 14, 17, 19

Llave allen de 6

Llave de tubo de Ø10

Broca Ø 4, 6

Taladradora

Sierra circular Ø 19, 22, 48

Tijeras

Remachadora M6

Simbología



Frágil



Atención corte!





Riesgo eléctrico

Documentación incluida

Guía rápida	1002430934
Garantía	220AA10017

Advertencias

 El personal instalador debe poseer una formación suficiente en Aire Acondicionado de vehículos.

 **dirna Bergstrom, s.l.** queda exenta de responsabilidad si se producen averías que procedan de una inadecuada manipulación ó instalación del equipo, ó por modificaciones y sustituciones efectuadas sin nuestra expresa autorización por escrito.

 **Cantidad de carga de gas refrigerante R-134a, a introducir en el circuito: 300 gr.**

 Véase **procedimiento de garantía** del producto incluido en **Diagnos de Averías**.

 Véase **Manual de Usuario** del equipo para el correcto funcionamiento del mando a distancia y del panel de control.

 Al finalizar la instalación se debe entregar al usuario: **Manual del Usuario, Garantía y Diagnos de averías**.

OPERACIONES PREVIAS:

- Desconectar batería.
- Desmontar el panel interior de distribución de aire de unidad evaporadora.

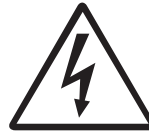

1

POR INTERIOR CABINA:

Presentar plantilla suministrada y marcar taladros.

Opción A: En caso de existir 2 camas, presentar plantilla entre ambas.

Opción B: En caso de existir 1 cama, presentar plantilla por encima de la cama.

Opción C: Desmontar guantera inferior cama, presentar plantilla.

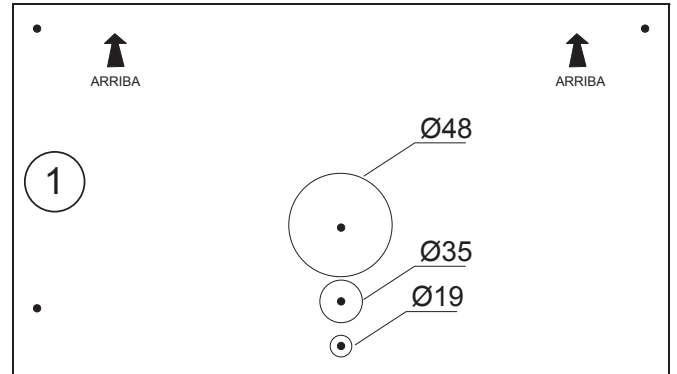

2

Dar taladro Ø4 pasante con broca larga en posición de taladro Ø48, después efectuar los siguientes taladros.

- A- dar (1) Ø35 sólo en el tapizado
- B- dar (1) Ø19 sólo en el tapizado
- C- dar (1) Ø48 sólo en el tapizado
- D- dar (4) Ø22 sólo en el tapizado

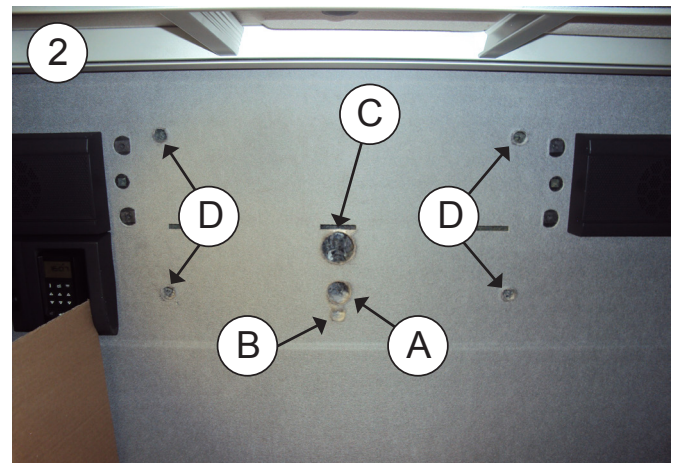
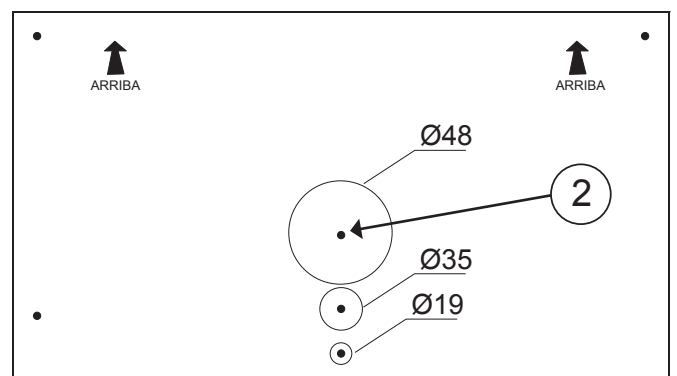

3 **POR EXTERIOR CABINA:**

Presentar plantilla a nivel por exterior, tomando como referencia el taladro efectuado $\varnothing 4$ y marcar y dar taladros restantes.

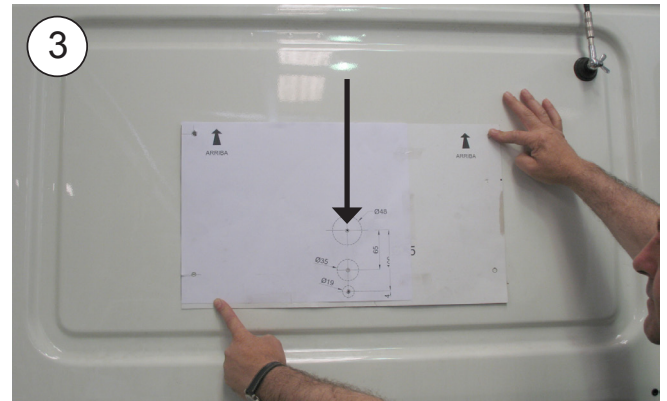
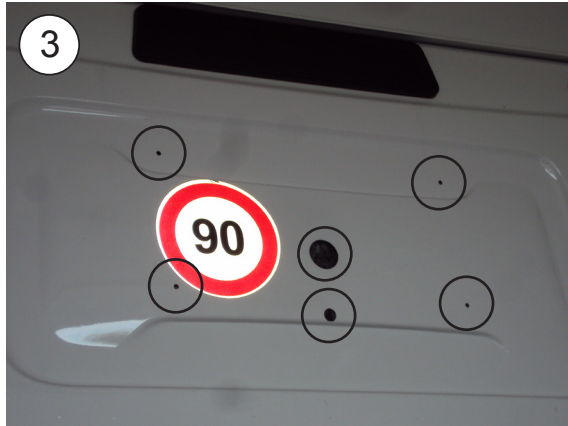

4 Introducir por interior esparragos M6 con tuerca y arandela como se indica.



5 Fijar por el exterior con arandela de goma, plana y tuerca autoblocante sujetando por parte interior con llave de tubo 10.

6 Colocar tapones de tuerca y pasamuros.

7 Pasar tubo desagüe por taladro $\varnothing 19$, por el pasamuros, hacia el interior cabina.

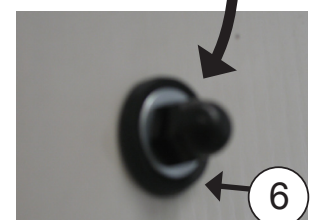
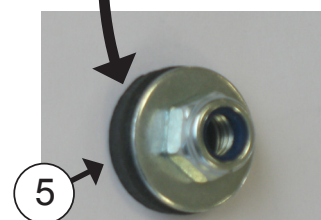
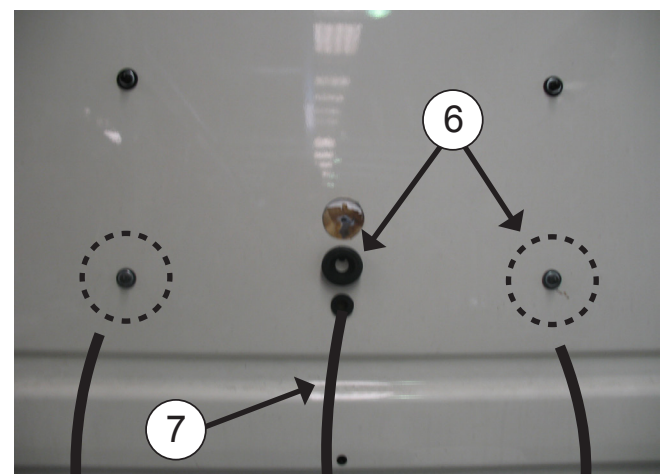

8 En los espárragos roscar (3) tuercas M6 con (3) arandelas planas Ø 6 quedando éstas a ras del tapizado.

VER ESQUEMA ADJUNTO

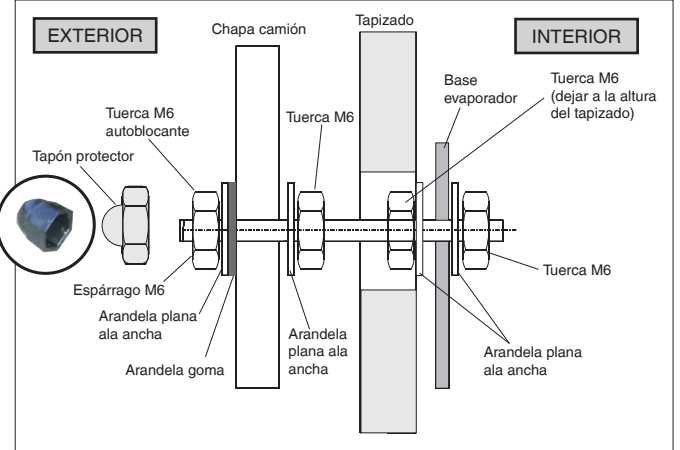

MUY IMPORTANTE

En el caso de tapizados con inclinación el conjunto evaporador tiene que quedar vertical o inclinado de la parte inferior hacia fuera para evitar que el agua de condensación caiga al tapizado.

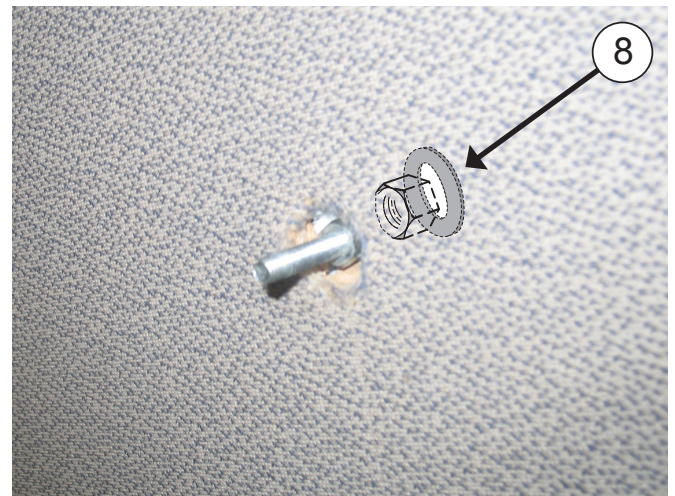
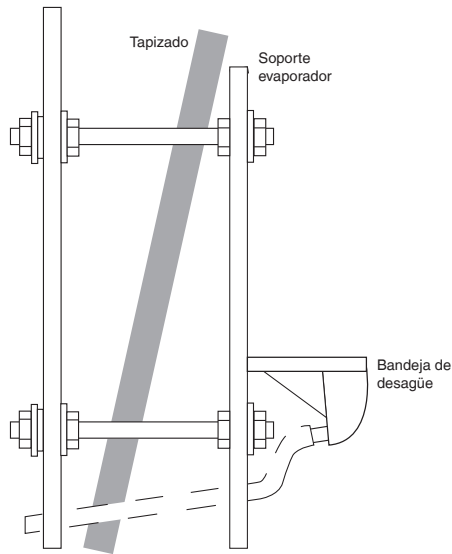

9 Pasar tubo desagüe por taladro de la base del evaporador y conectar a la bandeja de desagüe.

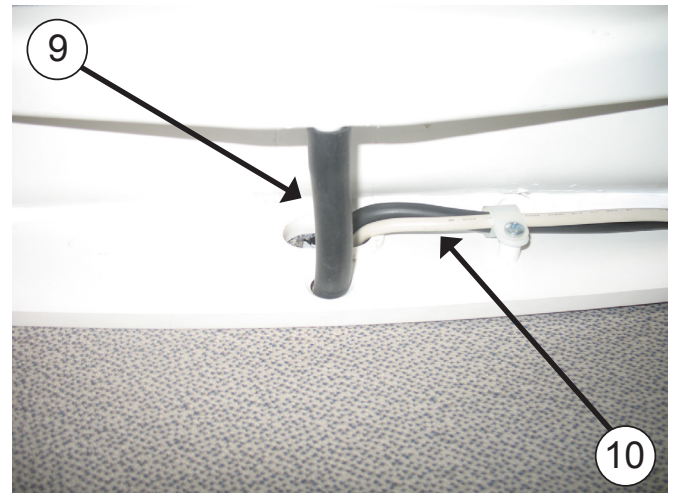

10 Pasar cableados por taladro Ø 35 hacia el exterior.



11 Introducir base evaporador sobre espárragos y Fijar con (4) arandelas planas (4) grower y (4) tuercas M6.

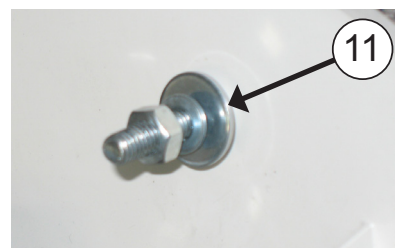
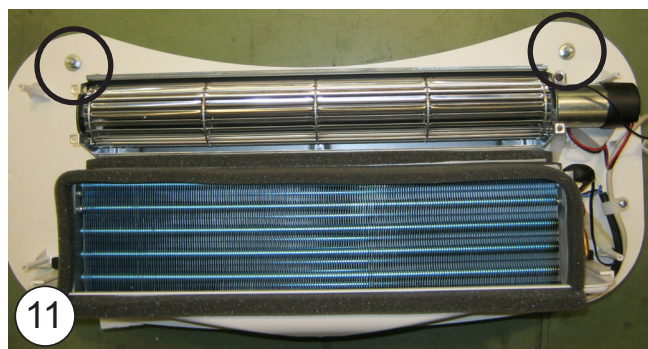

MUY IMPORTANTE

El desagüe debe quedar con la suficiente caída para evitar la caída del agua al tapizado.

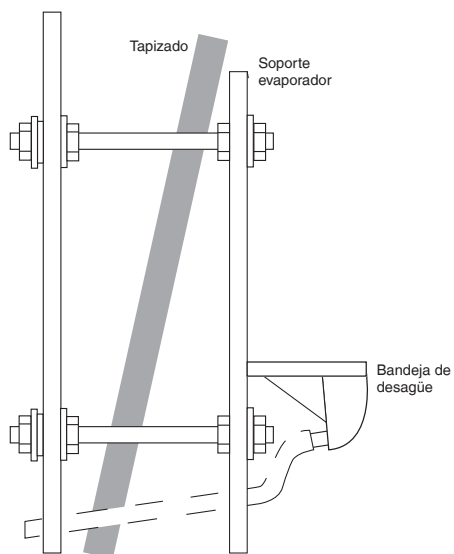

12 Conectar sonda recirculación y cable de comunicaciones.

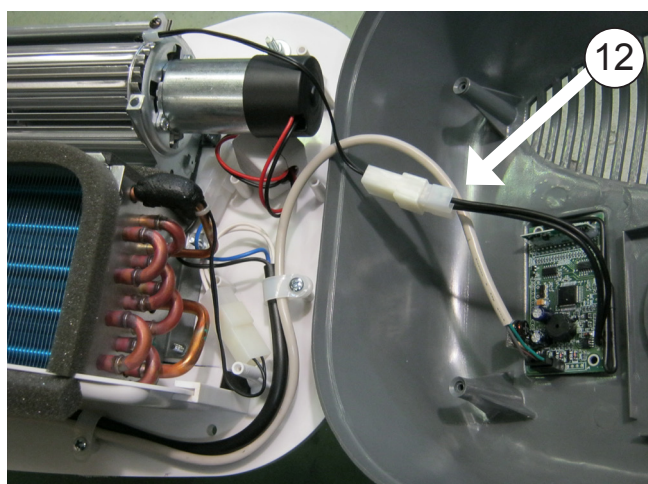

13

Volver a fijar el panel interior de distribución de aire con sus tornillos, usando destornillador imantado y colocar tapones.



MONTAJE CONDENSADOR:

Importante: Dependiendo del vehículo podemos colocar las salidas de las tuberías por el lado derecho o por el lado izquierdo.

1 Presentar plantilla suministrada y marcar taladros teniendo en cuenta la longitud de la tubería (del evaporador al condensador).

2 Desmontar tapa y soltar el cableado del ventilador del condensador.



3 Dar taladros a Ø 9, colocar tuercas remache.

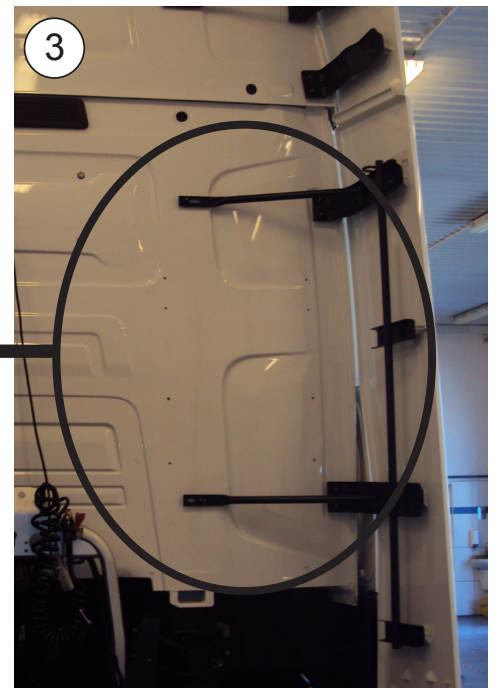

4 Fijar Unidad con (8) tornillos 6/100X30, arandela grower y plana cuando apoye en plano.

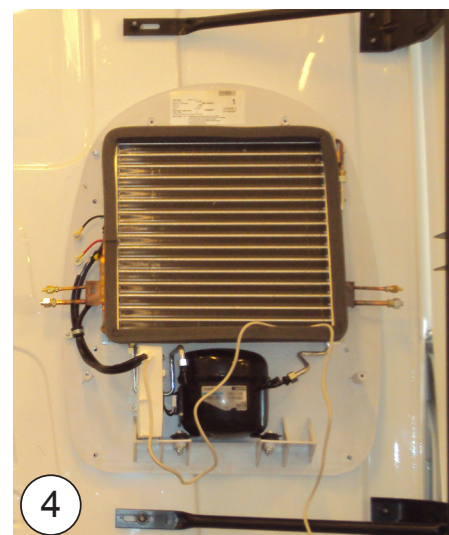

5 (*)- en los casos que no apoye en parte lisa, colocar separador de 10/20/40 mm.y tornillo 6/100x40/60/70.
VER DETALLE A

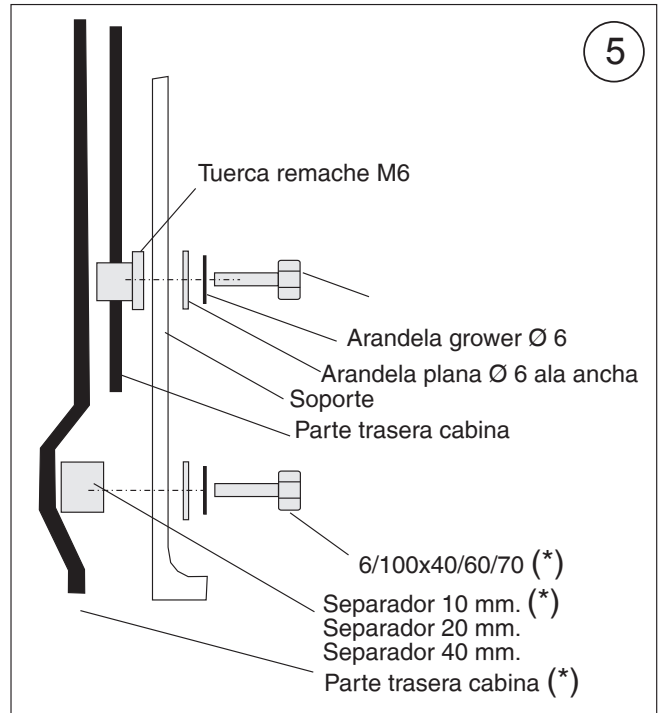

6 Colocar pasamuros alrededor de los racores del serpentín.

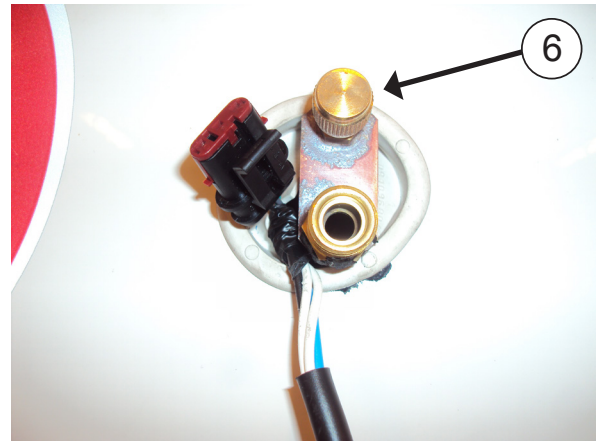

7 Conectar cableado (A) y racores en evaporador y sellar con cinta antigoteo (B).

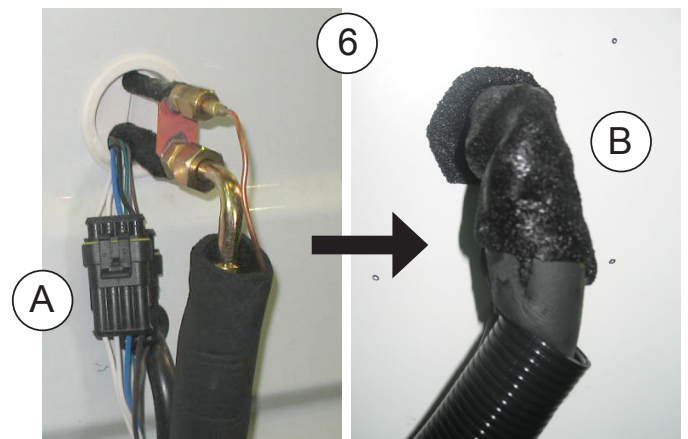

8 Conectar tuberías y cableado en unidad condensadora.

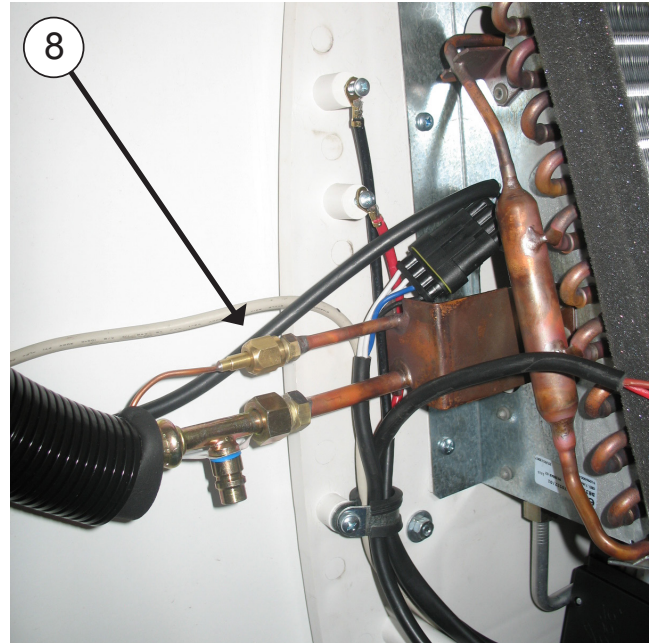

9 Presentar protector de tuberías con junta, marcar y taladrar a Ø4 y fijar con tornillos rosca chapa 4,8x19mm.



10

Pegar soportes de plástico y fijar tubería, cableados y tubo desagüe (limpiar zona montaje).

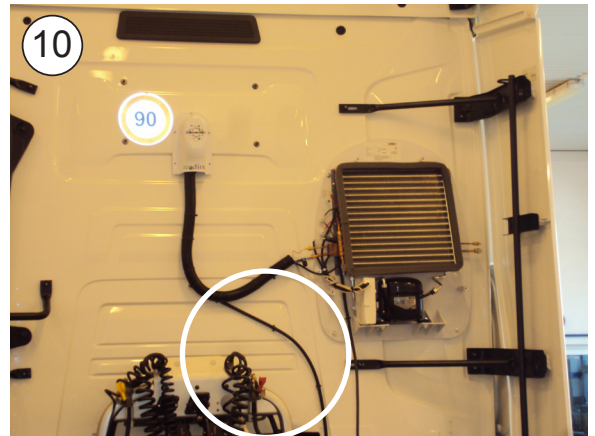

11

Colocar válvula de drenaje.



12

Abrir parrilla delantera y desmontar tapas de conexiones y paso de cableados originales (*)

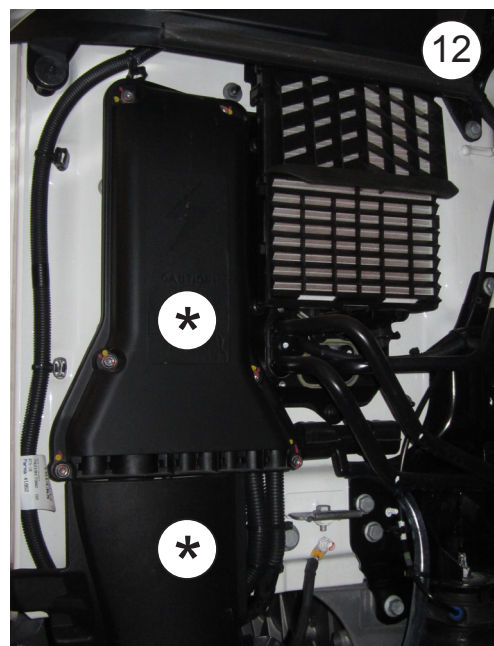

13

Conectar cableado a tomas originales de (+) y (-) y pasarlo junto a cableados originales. Fijar fusible con brida a cableado original. Volver a montar tapas originales.

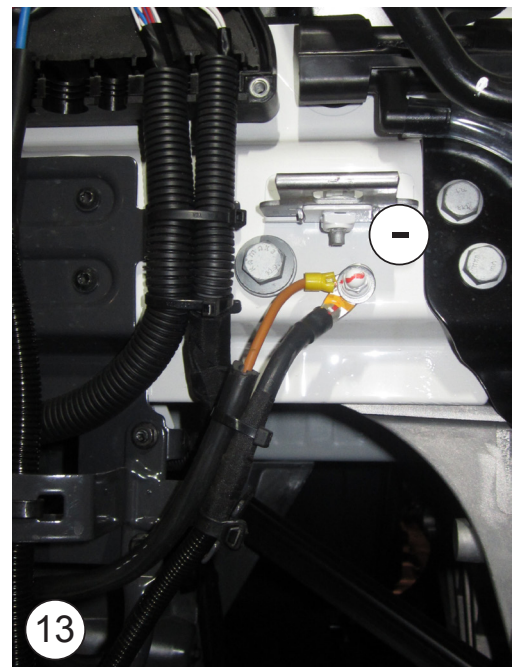
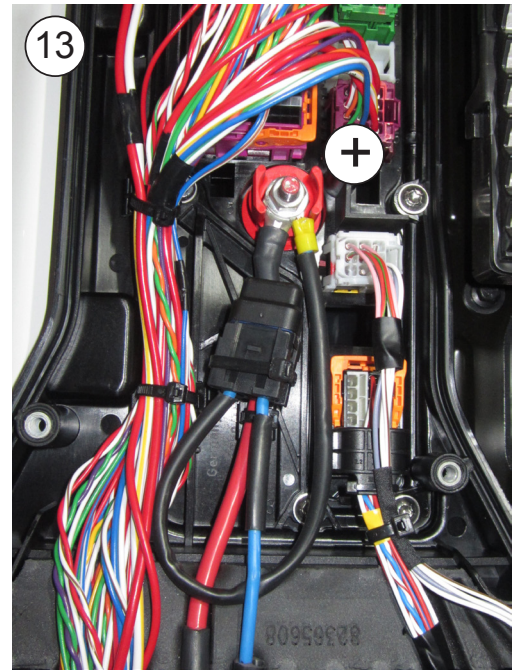
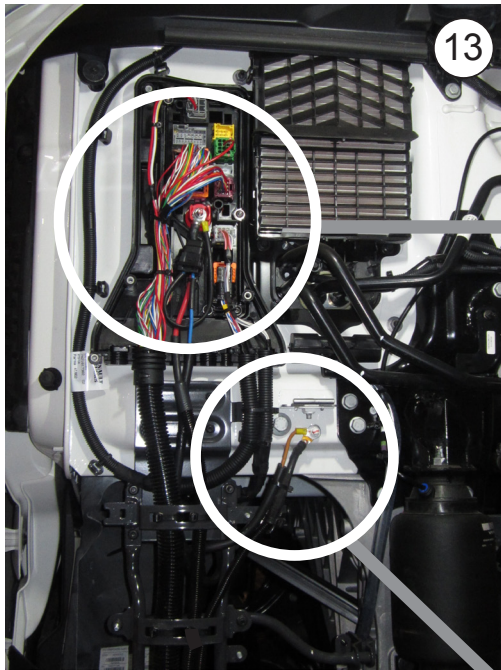

14

Abatir cabina y pasar cableado por la zona más idónea hacia la unidad condensadora, fijando con abrazaderas o bridas.

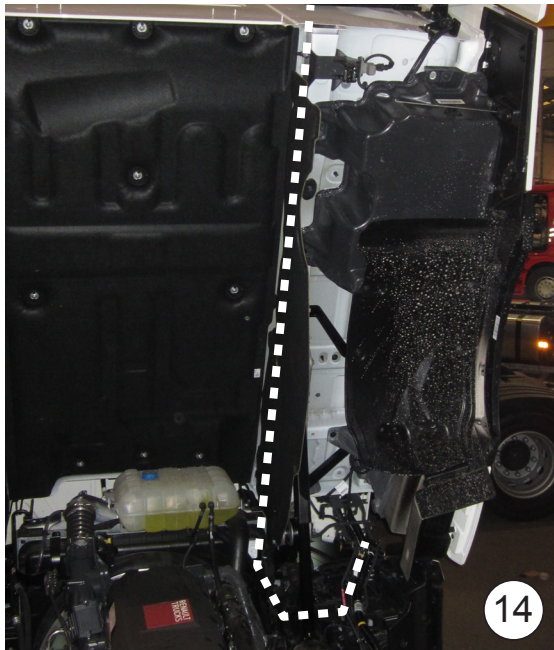
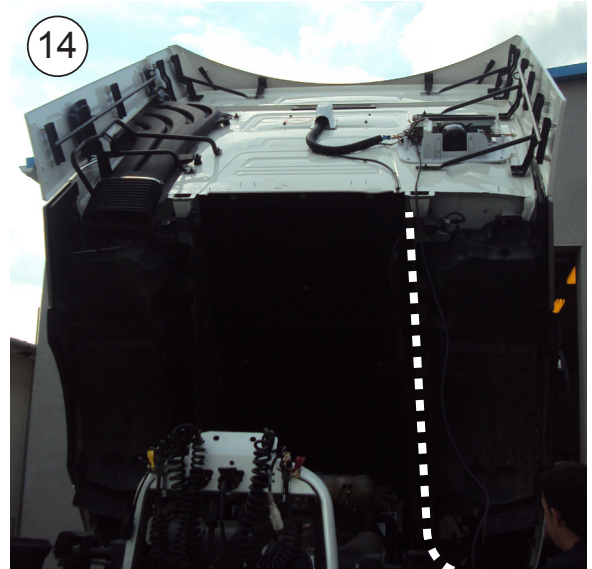
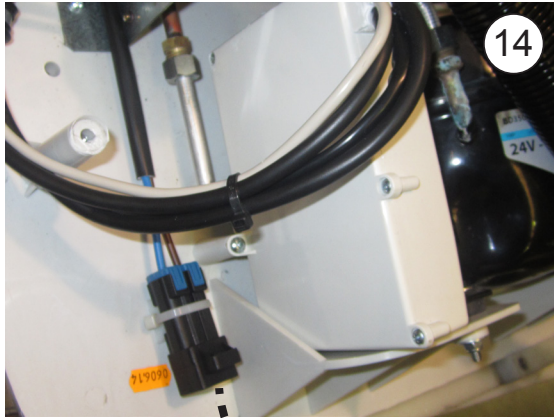

Desmontar protector (*) y pasar cableado por debajo de el protector.

15

Conectar cableado alimentación a la unidad.
 (-) = cables M y N.
 (+) = cables R y Az.

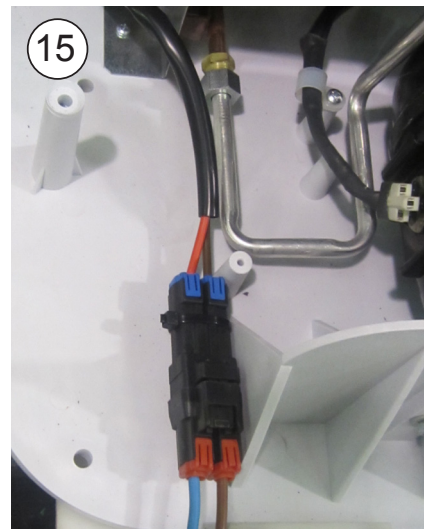

16 Colocar tapa con tornillos desmontados anteriormente.

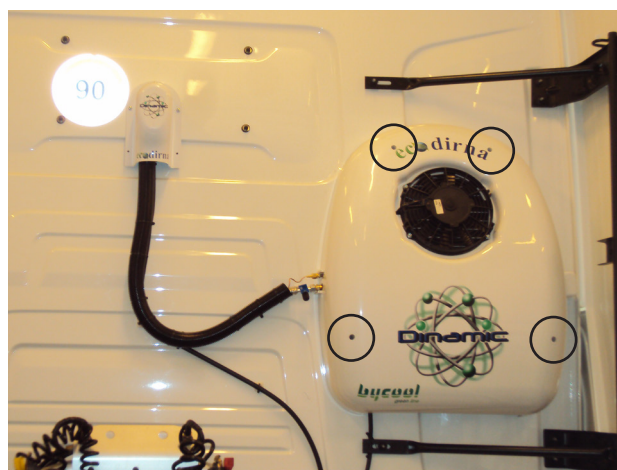

17 Colocar tapa protectora de racores c/tornillos rosca chapa 3,1x 11 en lado opuesto a tuberías.

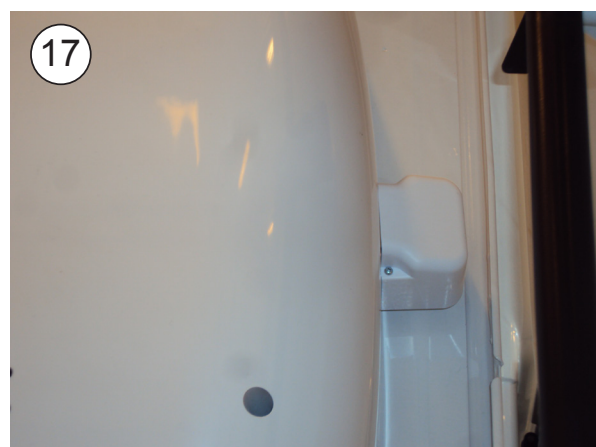

CARGA DE GAS:

18 Hacer vacío en el circuito durante al menos 30 minutos.

19 Introducir 300 gr.de carga de gas R134a y poner el equipo en marcha.

20 VISTA GENERAL DE LA UNIDAD CONDENSADORA Y TUBERÍA.

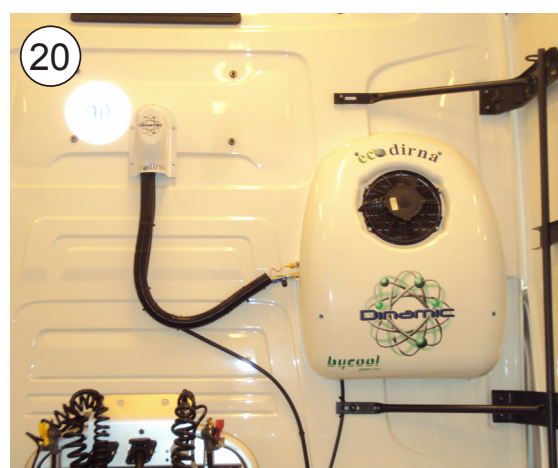

21 VISTA GENERAL DE LA UNIDAD EVAPORADORA.



Esquema eléctrico

¡AVISO IMPORTANTE!

Precaución de no invertir las polaridades al conectar la alimentación al equipo. Si esto sucediera, el panel de control no se enciende y el equipo no funciona.

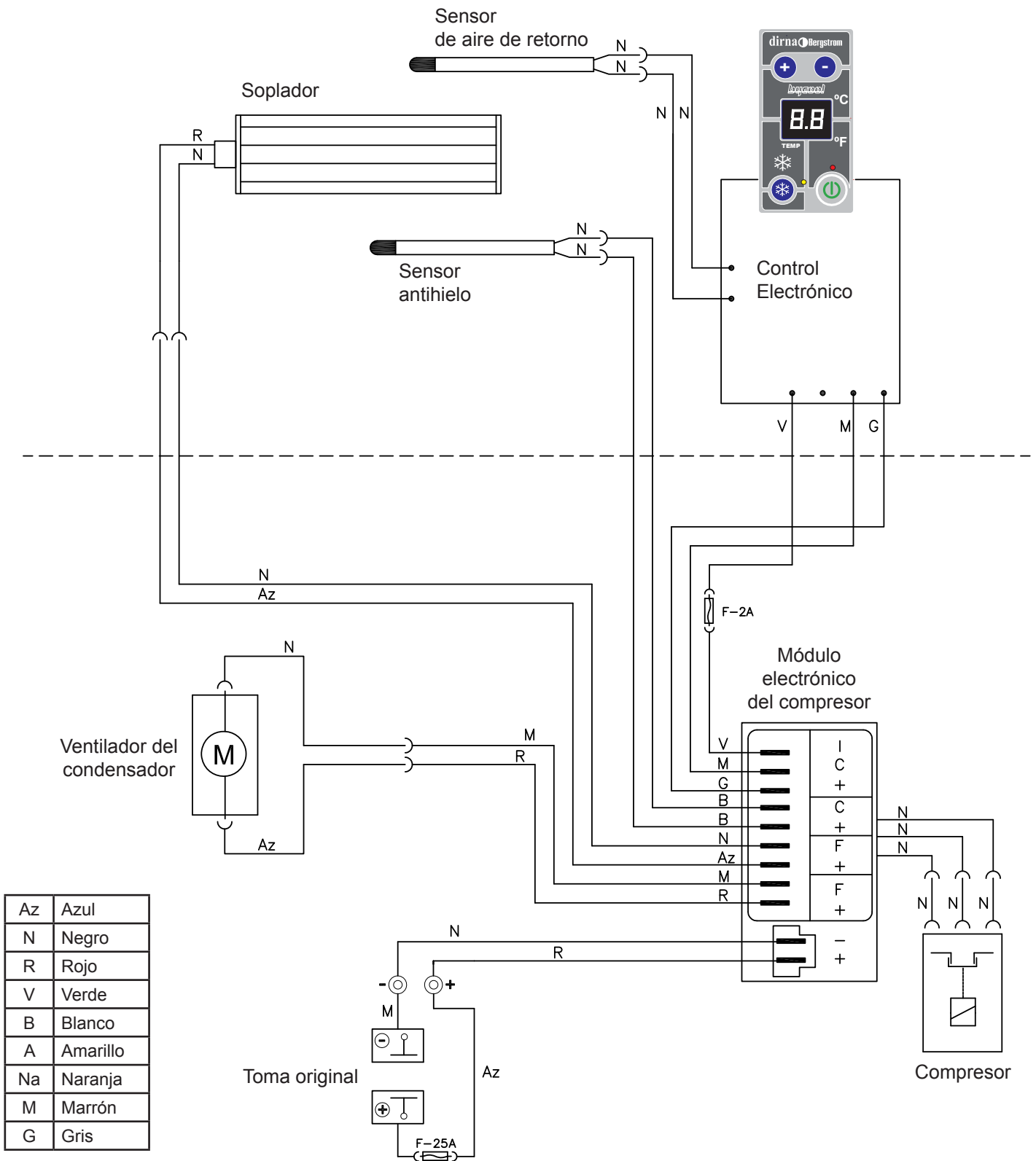

Assembly Recommendations

- Before starting assembly, please read instructions and follow them during installation process.
- Use the adequate tools for each operation.

Electricity

- Disconnect ignition key.
- Disconnect battery before starting assembly.
- Make sure electric components are securely connected, checking their correct fitting.

Warning

If, during assembly, the unit becomes slanted or the cabin drops with the unit mounted, wait for at least 60 minutes from the moment the unit is horizontal before starting up.

Related documentation

Mounting instructions	1002435861
User's guide	1002430924
Troubleshooting	1002430925
Parts list	1002435862

Indications concerning position are:
 RIGHT: Passenger side
 LEFT: Driver side



Driving torques (N.m)			
Fillet	Steel Quality		Wrench opening
	8.8	10.9	
M6/100	10	13	10

Hoses assembly		
Driving torques (N.m)		
Hose size	Fitting Driving Torque	Tool
1/4"	13-15	Wrench 14mm.
3/8"	15-17	Wrench 19mm.

Tools

- Ratchet wrench of 10
- Cruciform screwdriver TOP 10
- Wrench of 10, 11, 14, 17, 19
- Allen key of 6
- Socket wrench of Ø10
- Broach Ø 4, 6
- Drill
- Circular saw Ø 19, 22, 48
- Scissors
- Riveter M6







Symbology

-  Fragile
-  Beware of cuts!
-  Electrical hazard

Documentation included

Quick guide	1002430934
Warranty	220AA10017

Warnings

-  The installing personnel must have a sufficient training in vehicles air conditioning.
-  **dirna Bergstrom, s.l.** shall not be responsible for breakdowns or damages coming from an inadequate handling or installation of the equipment or from modifications and substitutions carried out without our express and written authorisation.
-  Amount of refrigerant gas load R-134a to be introduced in the circuit: 300 g.
-  Please see product warranty procedure included in **Troubleshooting**.
-  Please see equipment **User's Guide** for its correct functioning of the remote control and control panel.
-  Once installation is finished, the following documents must be handed over to the user: **User's Guide**, **Warranty** and **Troubleshooting**.

PRIOR OPERATIONS:

- Disconnect the battery.
- Dismantle inner air distribution panel of evaporator unit.

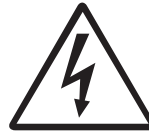

1

CABIN INTERIOR:

Introduce the template supplied and mark bores.

Option A: If there are 2 beds, place the template between the two.

Option B: If there is 1 bed, place the template on the bed.

Option C: Take down the bottom bed glove compartment and position the template.

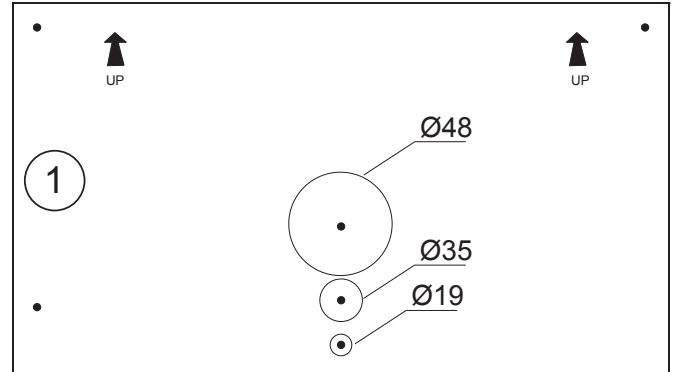

2

Make through bore Ø4 with long broach in bore position Ø48, and then make the following bores.

- A- make (1) Ø35 in the cover only.
- B- make (1) Ø19 in the cover only.
- C- make (1) Ø48 in the cover only.
- D- make (4) Ø22 in the cover only.

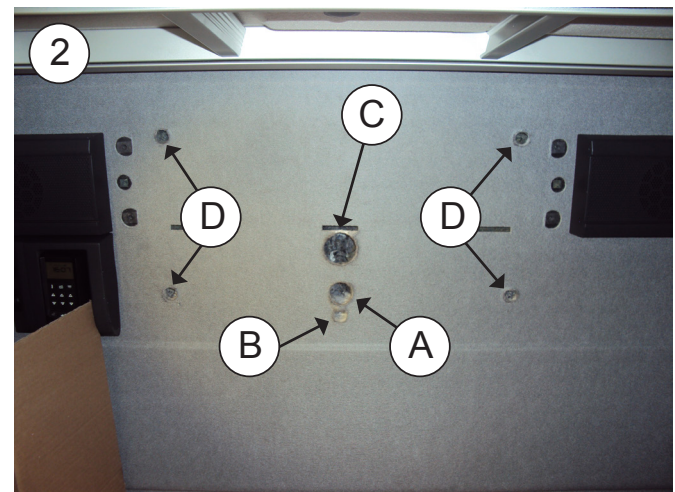
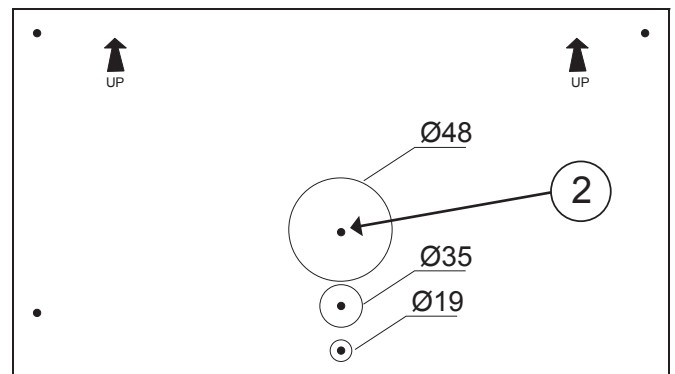

3 **CABIN EXTERIOR:**
Introduce the template level using the exterior, taking as reference the Ø4 bore made, mark and make the remaining bores.

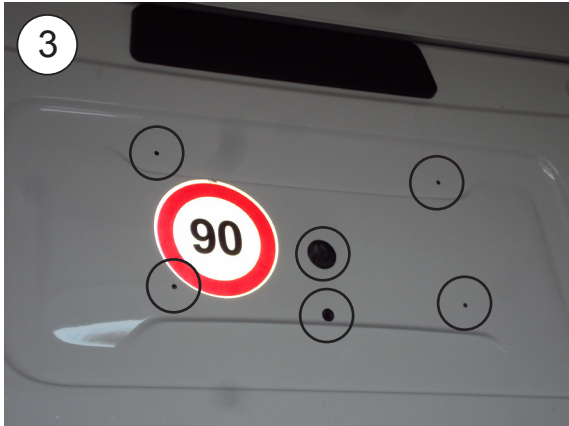

4 Introduce M6 studs in the interior with a nut and washer as indicated.

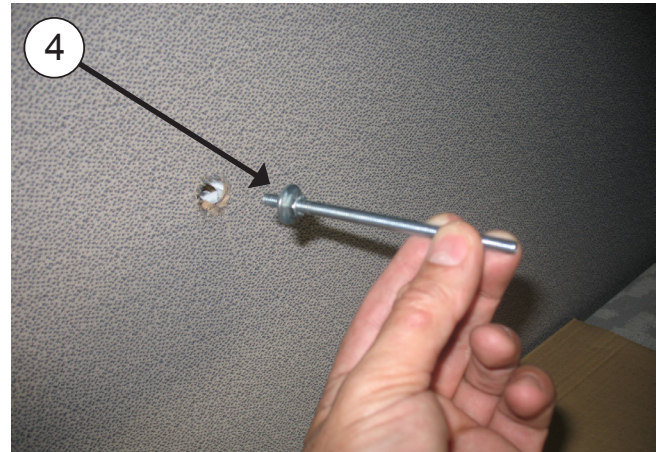

5 Secure the exterior with a rubber washer, a flat washer and a self-locking nut, securing at the bottom with a socket wrench of 10.

6 Position bushing and nut covers.

7 Pass the waste water pipe through the bore of Ø19, through the bushing, towards the inside of the cabin.

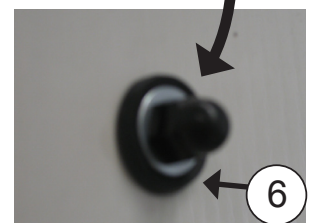
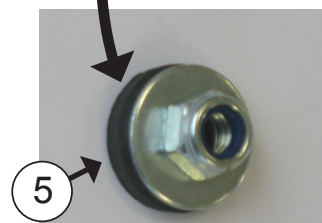
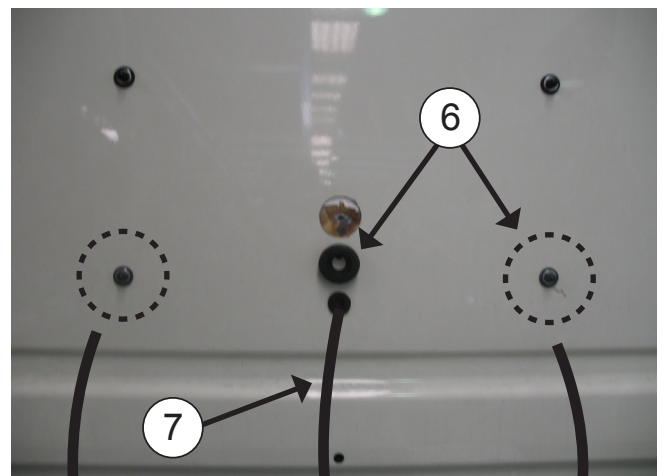

8 On the studs, thread (3) M6 nuts with (3) flat washers Ø 6, which should be level with the cover.
SEE ATTACHED DIAGRAM

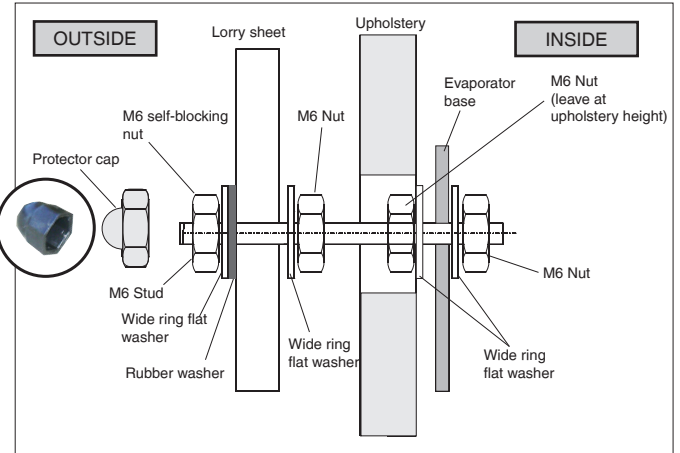

VERY IMPORTANT
 In the case of slanting upholstery, the evaporator unit must be vertical or sloping from the lower section to the outside in order to prevent the condensation water from dropping onto the upholstery.

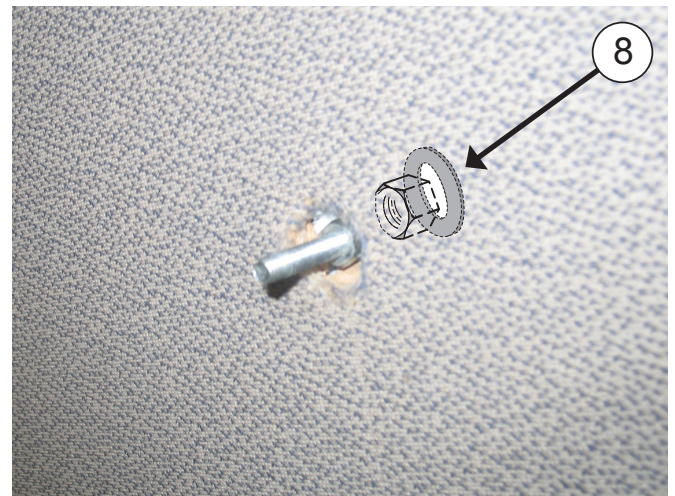
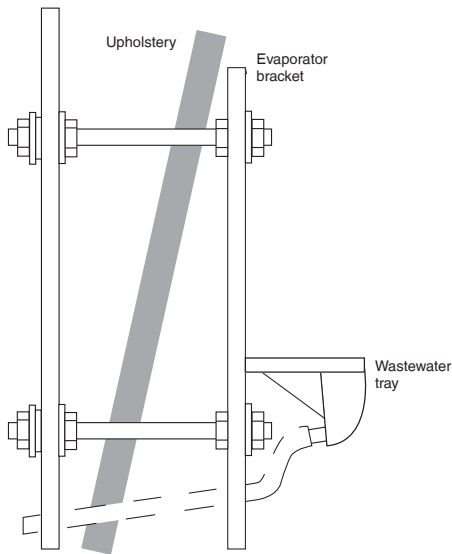

9 Pass drain tube through the hole of the base of the evaporator drain pan.

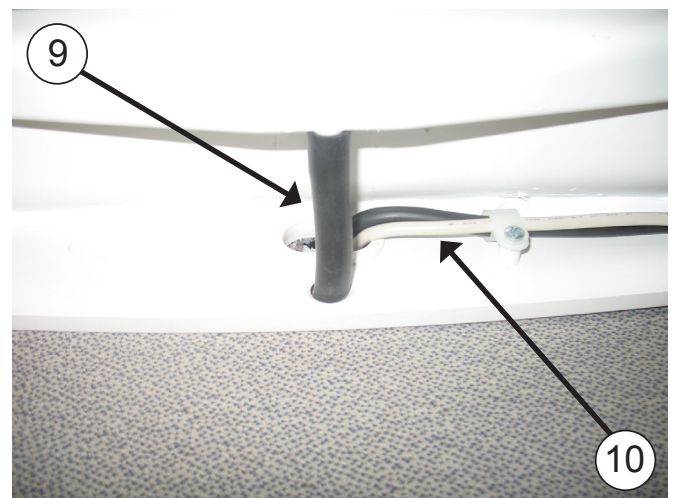

10 Pass the cabling through the Ø 35 bore towards the exterior.



11

Introduce the evaporator base on the studs and secure with (4) flat washers, (4) Grower washers and (4) M6 nuts.

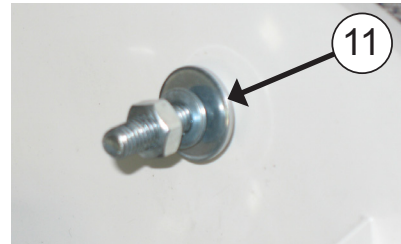
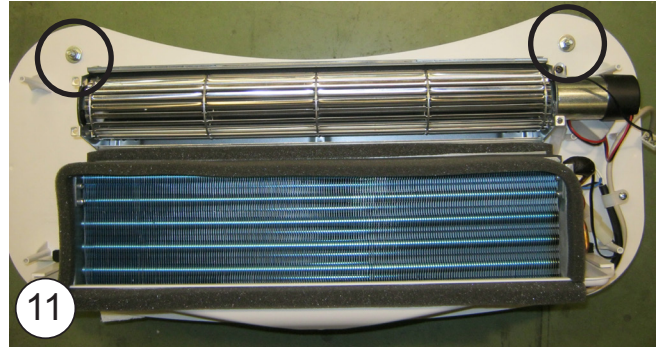
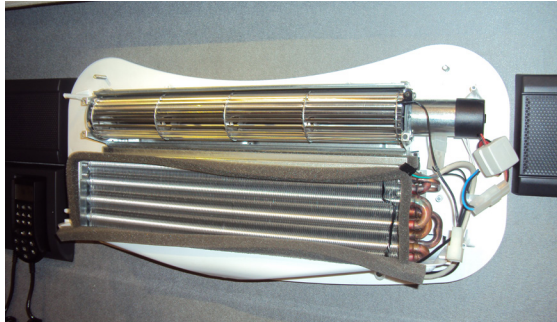

VERY IMPORTANT

The wastewater run-off must be sufficient to prevent water from dropping onto the upholstery.

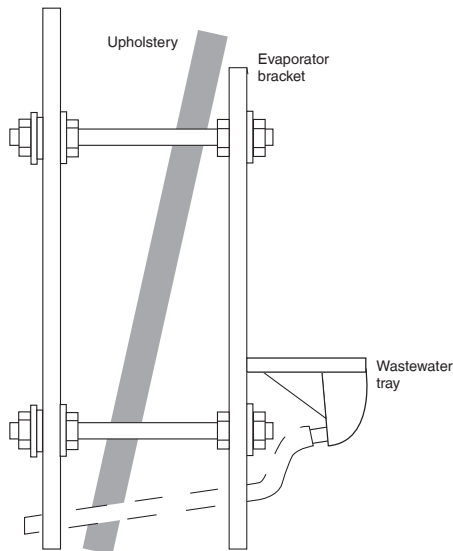

12

Connect recirculation sensor and communications cable.

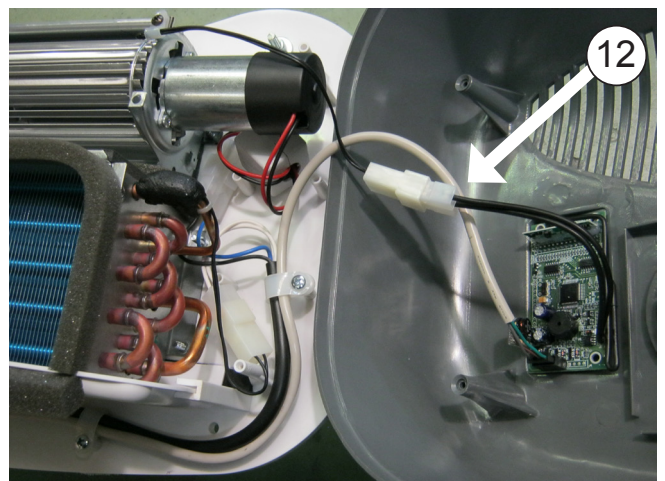

13

Reattach the inner air distribution panel with its screws, using magnetized screwdriver and place caps.



CONDENSER ASSEMBLY:

Important: Depending on the vehicle, we can position the pipe outputs on the right or left side.

1 Position the template supplied and mark the boreholes, taking into account the length of the pipe (from the evaporator to the condenser).

2 Dismantle cover and release the condenser fan wiring.



3 Make Ø9 boreholes and position the rivet nuts.

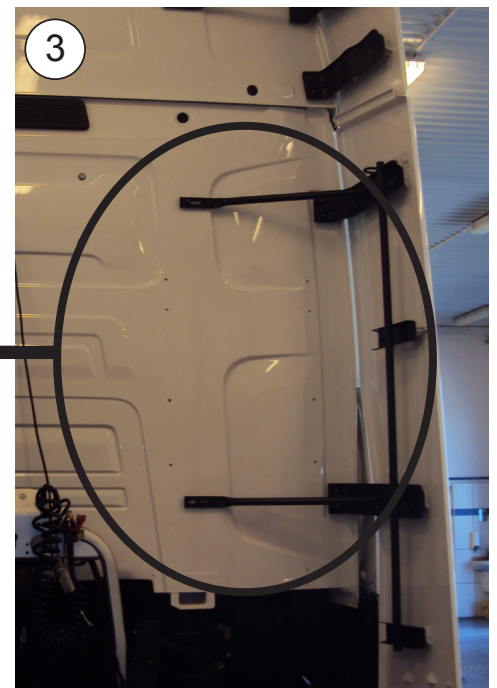
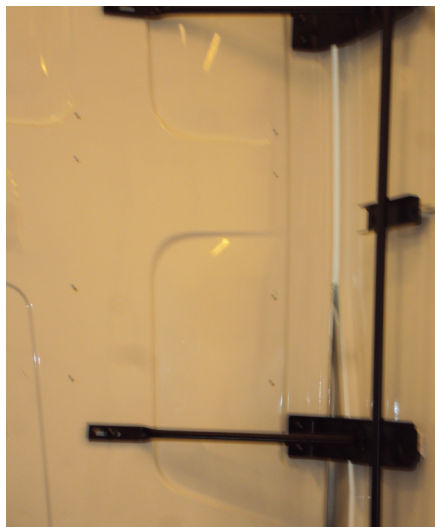

4 Fijar Unidad con (8) tornillos 6/100X30, arandela grower y plana cuando apoye en plano.



5 (*)- when not supported on the smooth section, use a 10/20/40 mm separator and 6/100x40/60/70 screw.
SEE DETAILS A

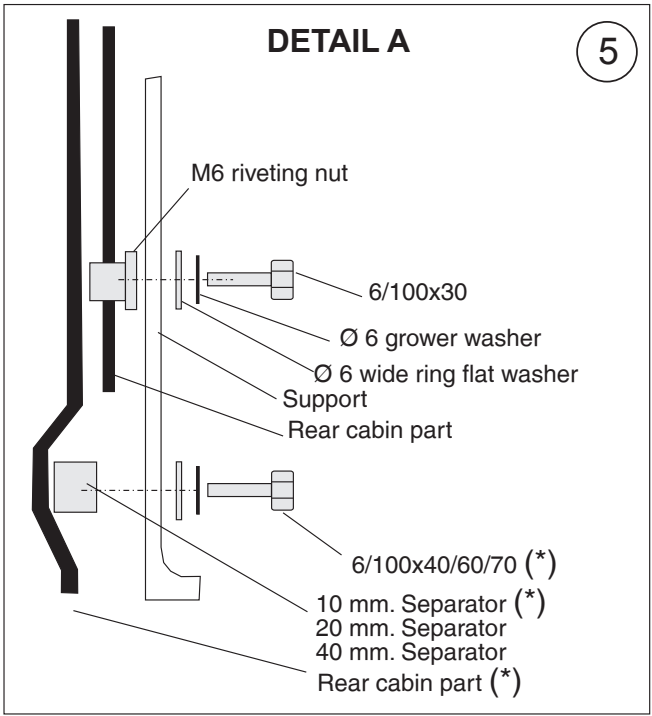

6 Place bushing around the coil couplings.

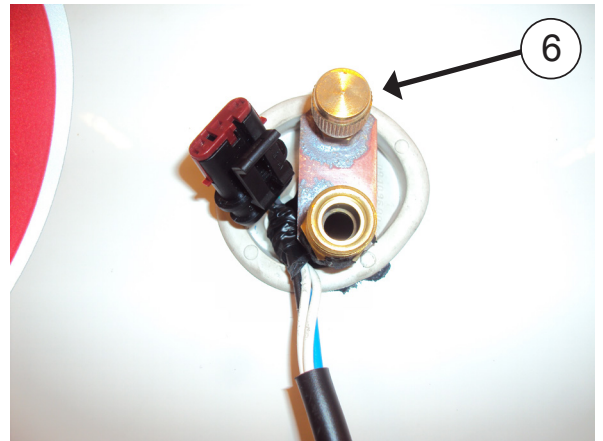

7 Connect cabling (A) and adapters in the evaporator and seal with drip-proof tape (B).

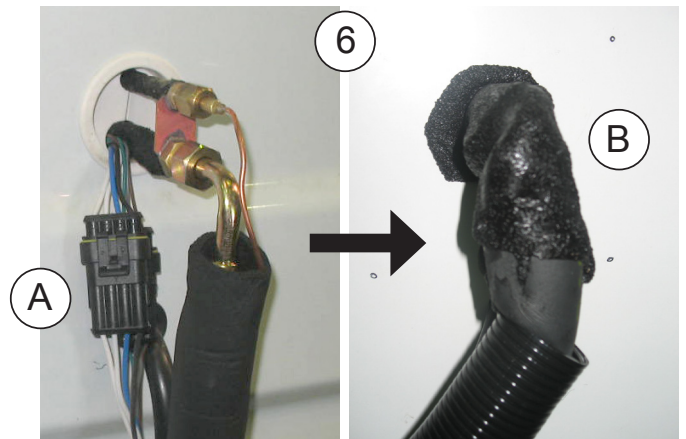

8 Connect piping and condensing unit wiring.

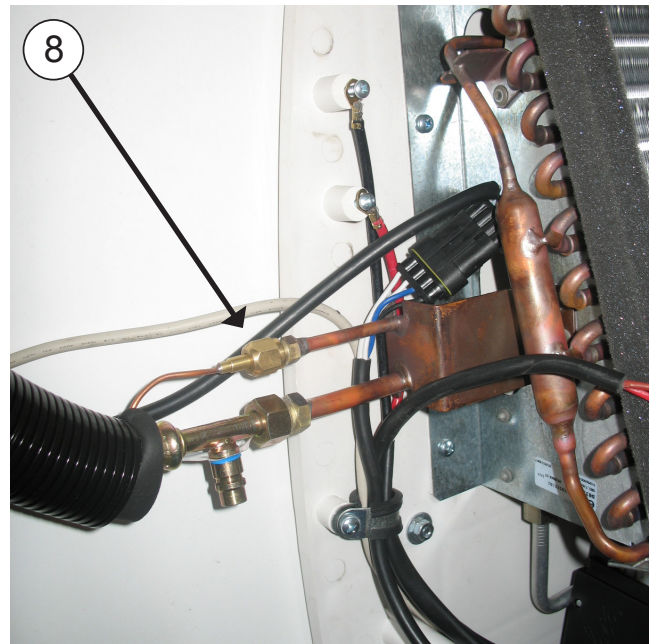

9 Introduce pipe protector with flange, mark and bore at $\text{\O} 4$, and secure with threaded metal screws of 4.8x19mm.



10

Stick the plastic supports and secure the pipe, cabling and wastewater pipe (clean the assembly area).

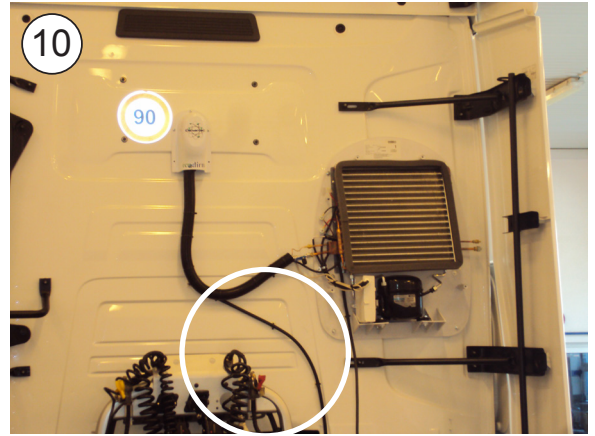

11

Position drainage valve.



12

Open front grille covers and dismantle original connection covers and original wiring route (*)

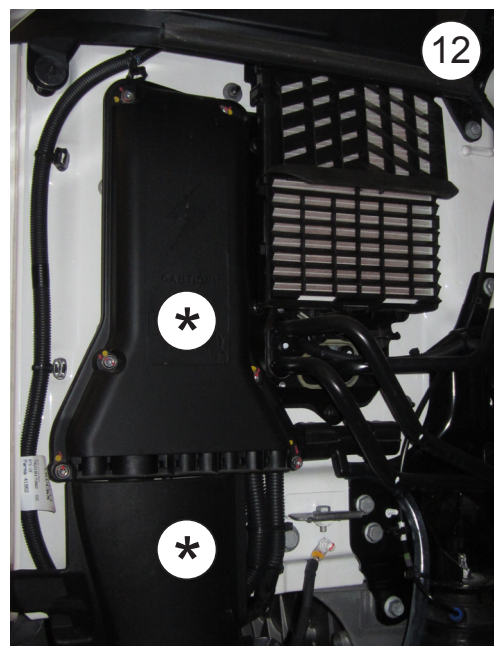

13

Connect wiring to original connections (+) and (-) and pass it alongside original wiring. Fix fuse with flange to original wiring. Refit original covers.

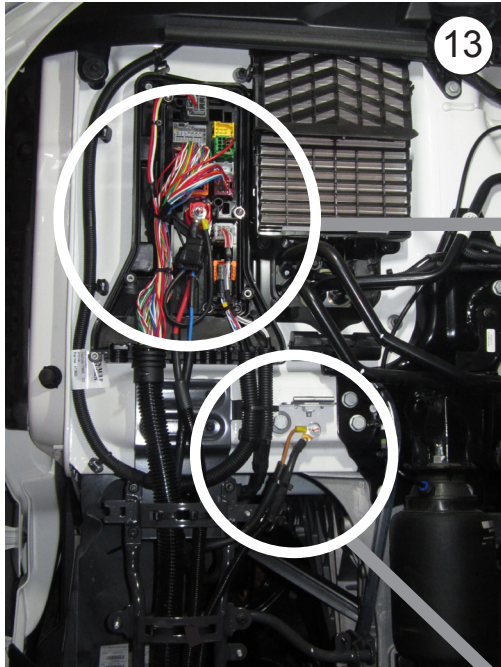

13

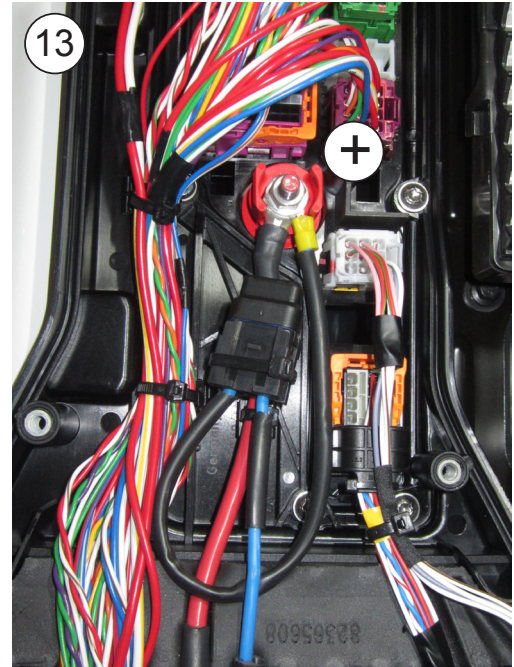

13

+



13

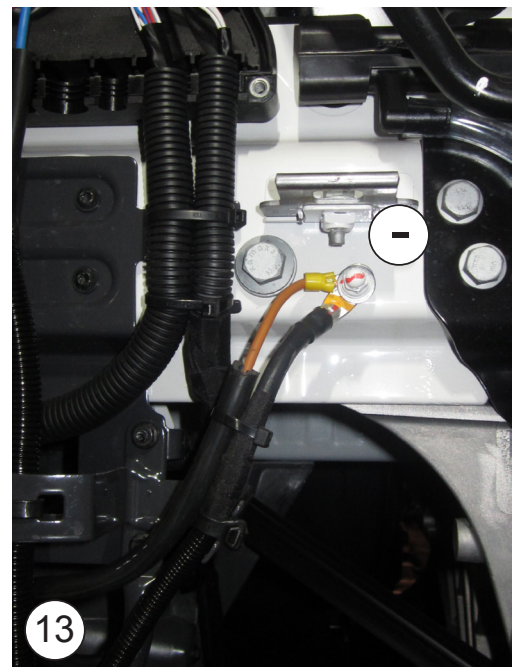

13

-

14 Open the cabin and pass the cabling through the most appropriate area towards the capacitor, securing with clamps or flanges.

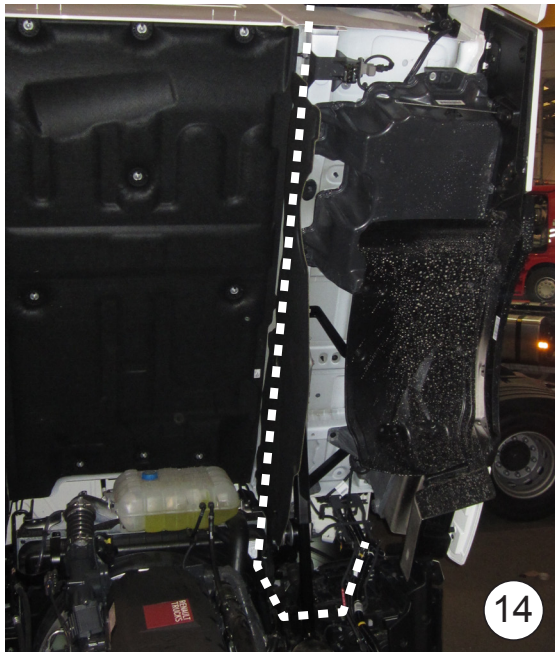
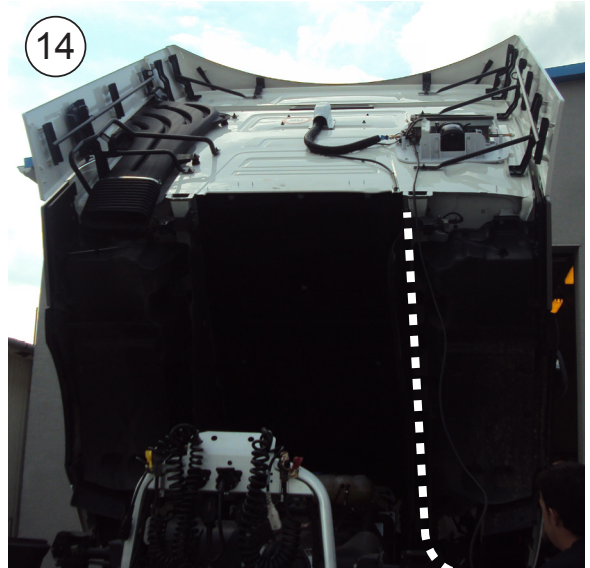
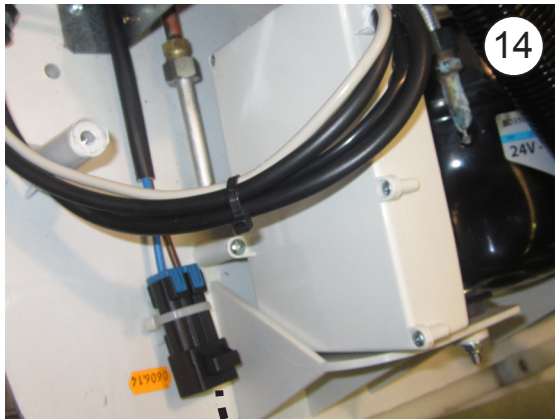

Dismantle guard (*) and move wiring under the protector.

15 Connect the power cabling to the unit.
 (-) = cables M and N.
 (+) = cables R and Az.

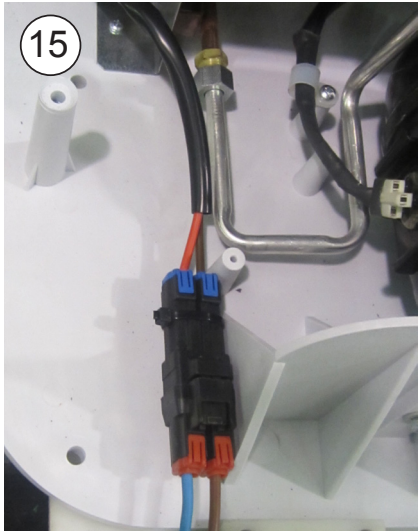

16

Position the cover with the previously dismantled screws.

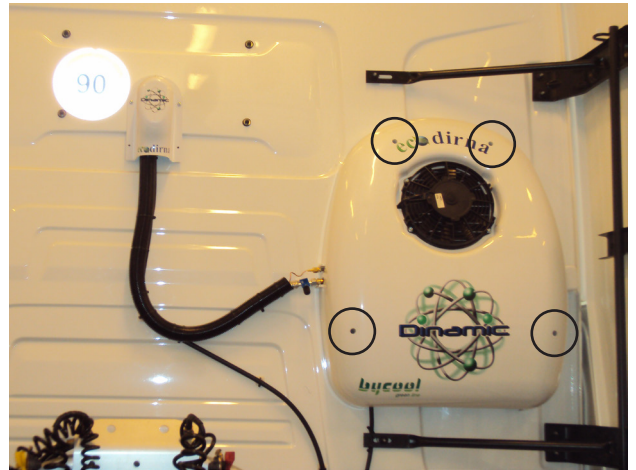
**17**

Position adapter protection cover with metal threaded screws 3.1x 11 on the side opposite the pipes.

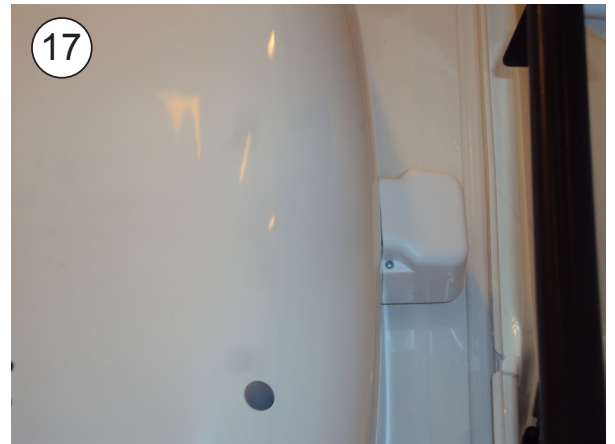
**GAS LOAD:****18**

Empty the circuit for at least 30 minutes.

19

Introduce 300 g of gas load R134a and start up the equipment.

20

GENERAL VIEW OF THE CONDENSATION UNIT AND PIPING.

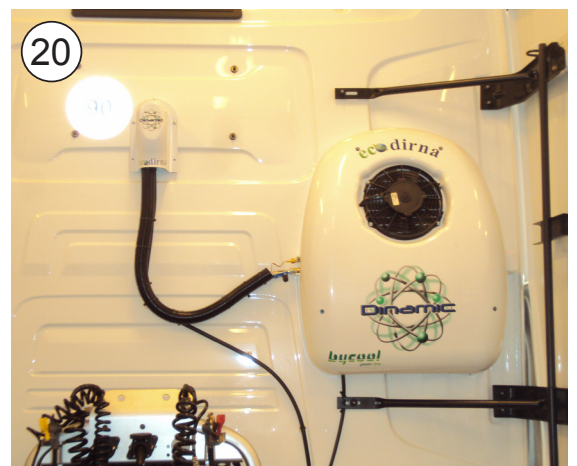

21 GENERAL VIEW OF THE EVAPORATION UNIT.



IMPORTANT NOTE!

Take care not to invert polarities when connecting the unit to the power supply. If this happens, the control panel does not come on and the unit does not work.

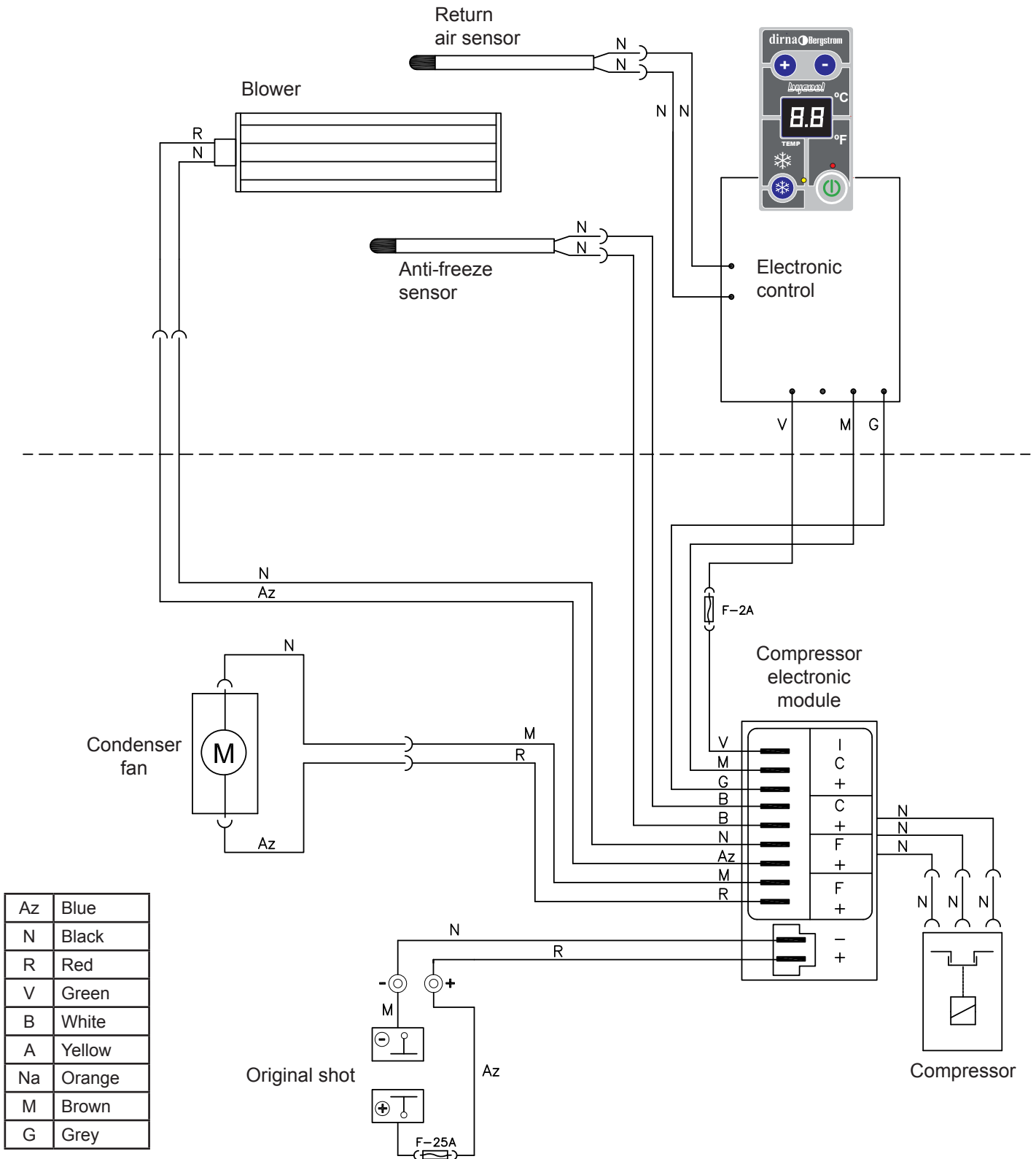

Recommandations Pour Le Montage

- Avant de commencer le montage de l'appareil, prière de lire les instructions et de les suivre attentivement.
- Utiliser les outils convenant à chaque opération.

Electricity

- Déconnecter la clé de contact.
- Déconnecter la batterie avant de commencer le montage.
- Vérifier le câblage des composants électriques et leur correcte installation.

Attention

Si pendant le montage, l'équipement s'incline ou si la cabine est repliée avec l'équipement monté, une fois que ce dernier récupère sa position horizontale, il faudra attendre au moins 60 minutes avant de le remettre en marche.

Documentation connexe

Instructions de montage	1002435861
Guide de l'utilisateur	1002430924
Solution des problèmes	1002430925
Liste de rechange	1002435862

Les indications relatives aux positions sont:

DROITE: Côté passager

GAUCHE: Côté conducteur

Couple de serrage (N.m)

Filet	Qualité d'acier		Clef
	8.8	10.9	
M6/100	10	13	10

Montage de tuyaux

Couple de serrage (N.m)

Tuyaux	Couple de serrage	Clef
1/4"	13-15	Llave fija 14 mm
3/8"	15-17	Llave fija 19 mm

Outils

Cylindre à cannelures et vanne d'arrêt de 10

Tournevis en étoile TOP 10

Clé plate de 10, 11, 14, 17, 19

Clé allen de 6

Clé à tube de Ø10

Broche Ø 4, 6

Perceuse

Scie circulaire Ø 19, 22, 48

Ciseaux

Riveteuse M6

Symbologie



Fragile



Attention aux coupures !





Risque électrique

Documentation included

Guide rapide	1002430934
Garantie	220AA10017

Garantie

 L'installateur devra posséder la formation pertinente en air conditionné sur véhicules.

 **dirna Bergstrom, s.l.** ne sera pas responsable des dommages ou des bris dérivés d'une installation ou d'une manipulation incorrecte ni des modifications réalisées sans autorisation expresse par écrit.

 **Quantité de charge de gaz réfrigérant R-134a, à introduire dans le circuit: 300 gr.**

 Voir la **procédure de garantie** du produit au **Diagnostic de problèmes**.

 Voir le **Guide de l'Usager** de l'appareil pour le fonctionnement correcte de la télécommande et du tableau de commande.

 Après l'installation, vous devez fournir à l'utilisateur: Manuel d'utilisation, garantie et diagnostic de pannes.

OPERATIONS PREVUES:

- Démontez la batterie.
- Démontez le panneau de distribution d'air de l'unité d'évaporation.



1

PAR L'INTERIEUR DE LA CABINE:

Présenter le modèle fourni et marquer les perçages.

Option A: S'il existe 2 berceaux, présenter le modèle entre les deux.

Option B: S'il existe 1 berceau, présenter le modèle audessus du berceau.

Option C: Démontez la boîte à gants inférieure du lit et présenter le modèle.

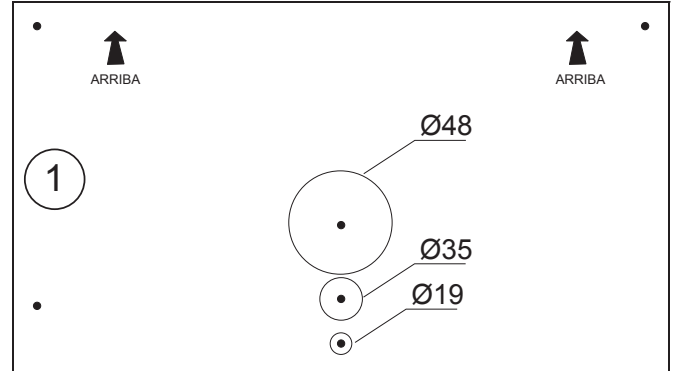

2

Procéder au perçage Ø4 en traversée avec une broche longue en position de perçage Ø48, ensuite effectuer les perçages suivants.

- A- Perçage (1) Ø35 seulement dans la tapisserie.
- B- Perçage (1) Ø19 seulement dans la tapisserie.
- C- Perçage (1) Ø48 seulement dans la tapisserie.
- D- Perçage (4) Ø22 seulement dans la tapisserie.

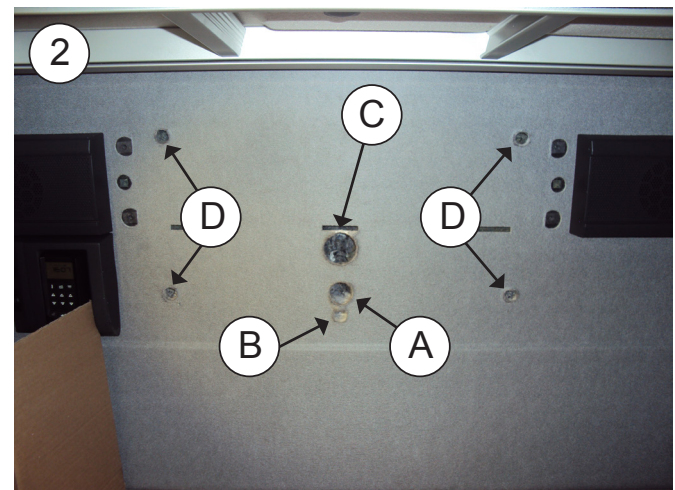
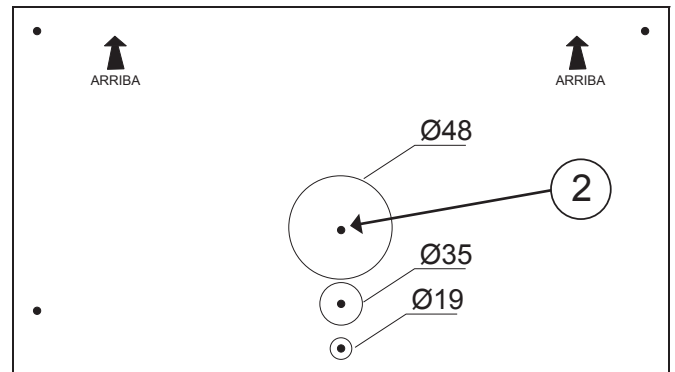

3 **PAR L'EXTERIEUR DE LA CABINE:**
Présenter modèle au niveau par l'extérieur, en prenant pour référence le perçage effectué Ø4 et marquer et effectuer les perçages restant.

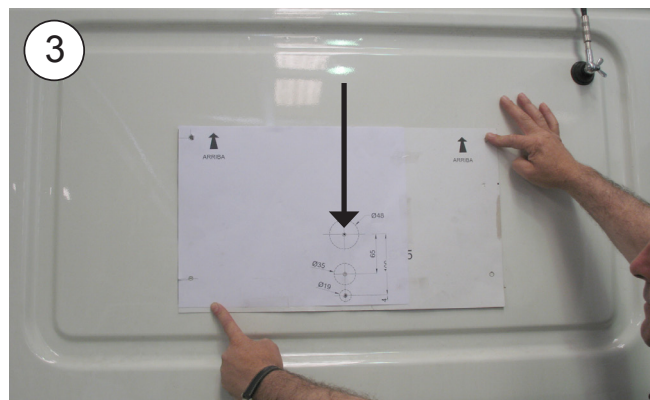
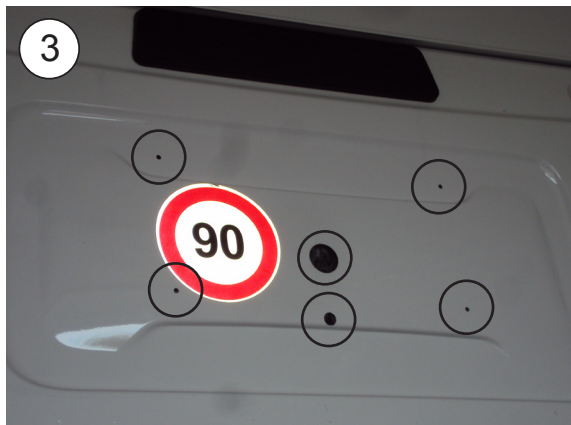

4 Introduire par l'intérieur des goujons M6 avec écrou et rondelle comme indiqué.



5 Fixer par l'extérieur avec une rondelle en caoutchouc, plane et écrou auto-serrant en fixant par la partie intérieure avec la clé à tube 10.

6 Placer les bouchons des écrous et traversées.

7 Passer le tuyau d'évacuation par le perçage Ø19, la traversée, vers l'intérieur de la cabine.

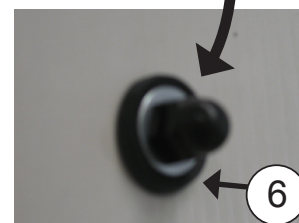
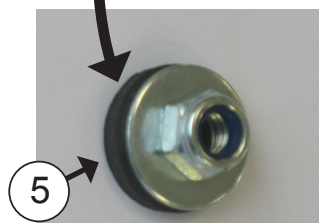
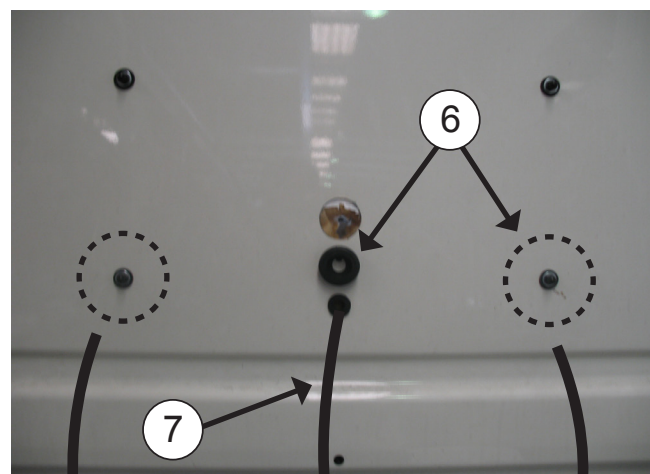

8 Sur les goujons, serrer (4) écrous M6 avec (4) rondelles planes Ø 6 en les laissant à ras de la tapisserie.
VOIR SCHEMA JOINT

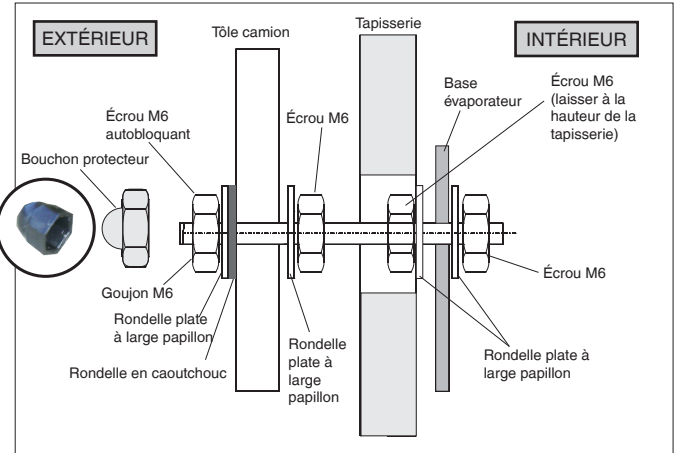

TRÈS IMPORTANT
 Dans le cas des tapisseries qui présentent une inclinaison, l'ensemble évaporateur doit rester vertical ou incliné depuis la partie inférieure vers l'extérieur, pour éviter que l'eau de condensation ne tombe sur la tapisserie.

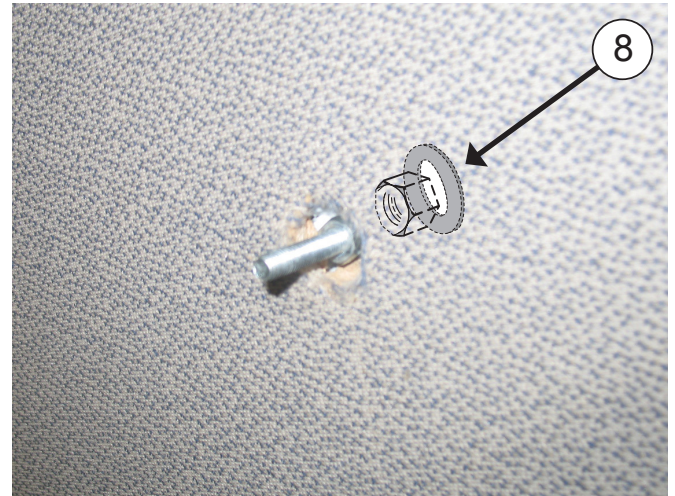
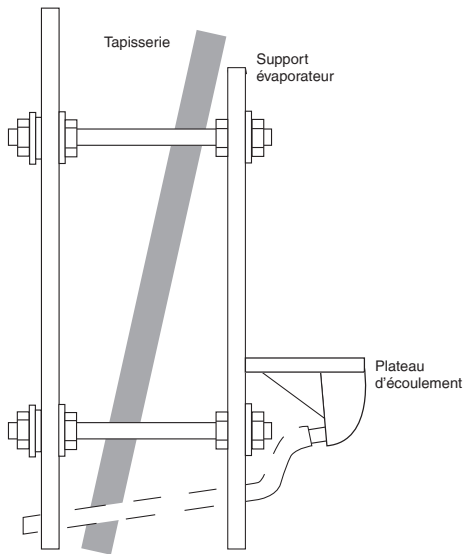

9 Passer le tube d'écoulement par le trou de la base de l'évaporateur et le brancher au plateau d'écoulement.

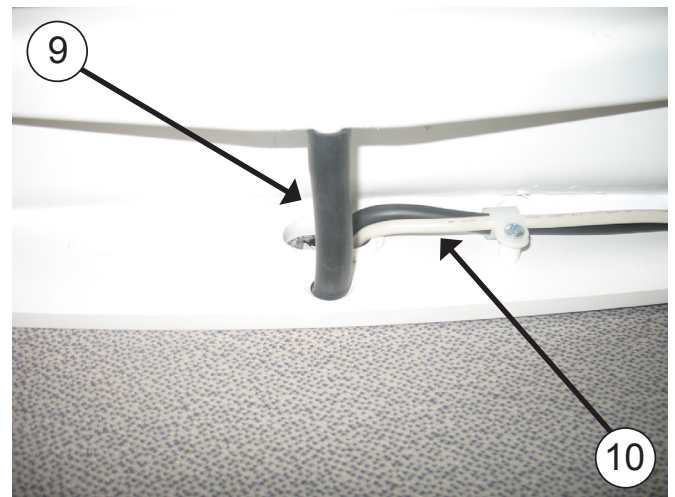

10 Passer les câblages par le perçage Ø 35 vers l'extérieur.



11 Introduire la base évaporateur sur goujons et fixer avec (4) rondelles planes (4) grower et (4) écrous M6.

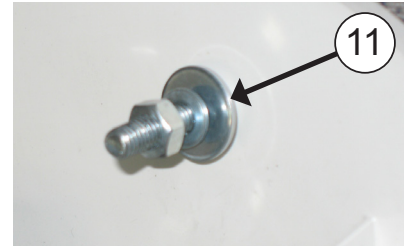
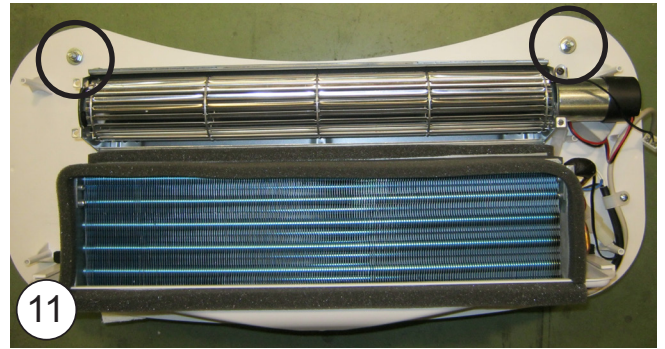
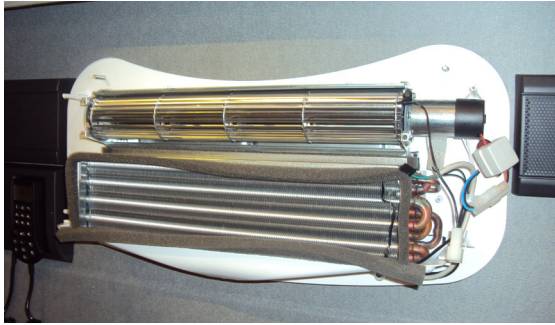

TRÈS IMPORTANT

L'écoulement doit présenter une chute suffisante pour éviter que l'eau atteigne la tapisserie.

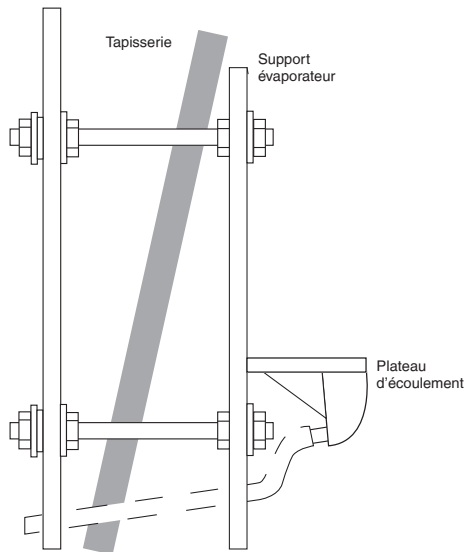

12 Connecter la sonde recirculation et câble de communications.

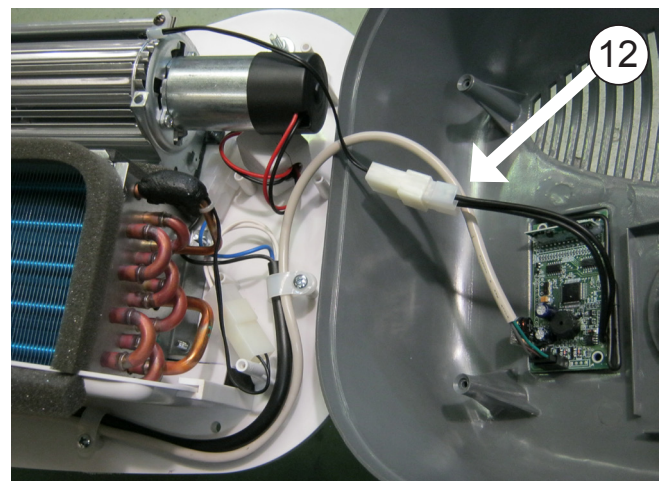

13

Fixer de nouveau le panneau intérieur de distribution d'air avec ses vis, en utilisant le tournevis aimanté et placer les couvercles.



MONTAGE DU CONDENSATEUR:

Important: En fonction du véhicule, il est possible de placer les sorties des tuyauteries par le côté droit ou par le côté gauche.

1 Présenter le modèle fourni et marquer les trous en tenant compte de la longueur du tuyau (de l'évaporateur au condenseur).

2 Démontez le couvercle et lâchez le câblage du ventilateur du condenseur.



3 Percer des trous de Ø 9 et placer les écrous rivet.

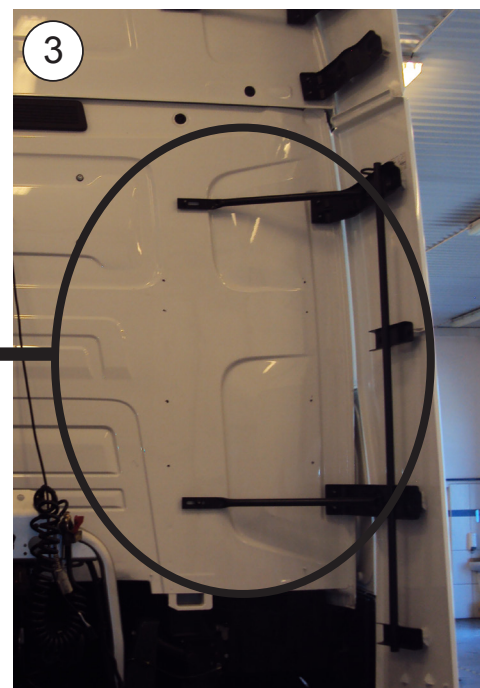

4 Fixer l'unité avec (8) vis 6/100X30 et une rondelle grower plate si la surface d'appui est plate.

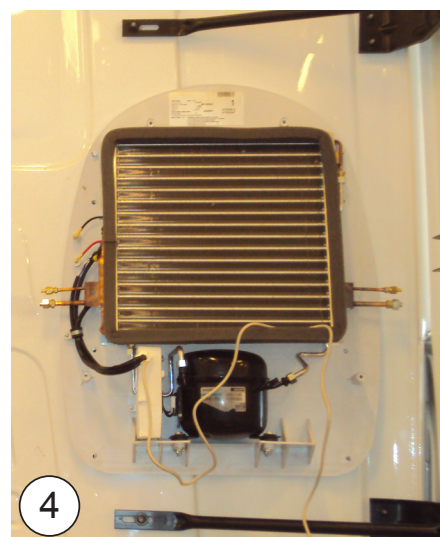

5 (*)- Dans les cas où l'appui ne se fait pas sur la partie lisse, placer un séparateur de 10/20/40 mm et une vis 6/100x40/60/70.
VOIR DETAIL A

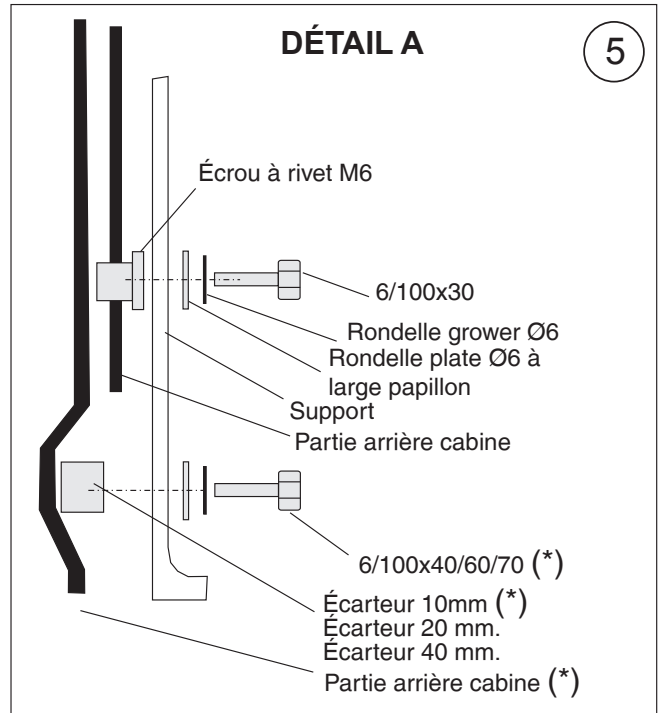

6 Placer les traversées autour des raccords du serpentin.

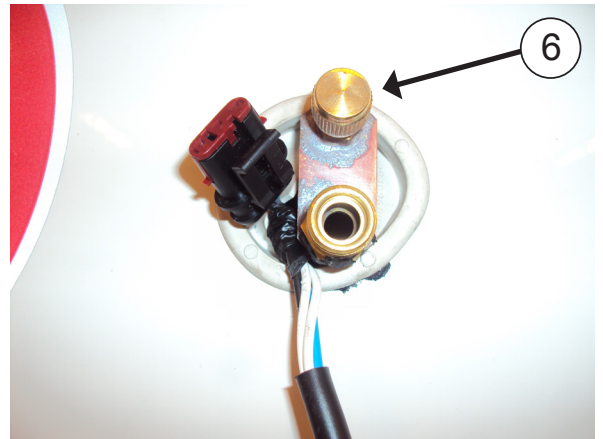

7 Connecter le câblage (A) et les raccords sur l'évaporateur et sceller avec ruban antiégouttement (B).

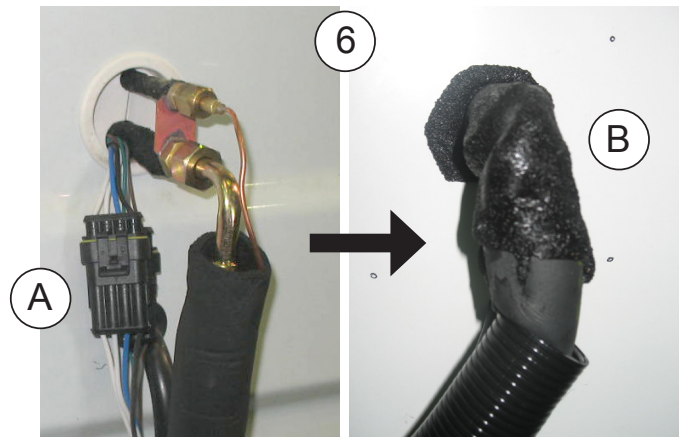

8 Connecter les tuyauteries et le câblage à l'unité de condensation.

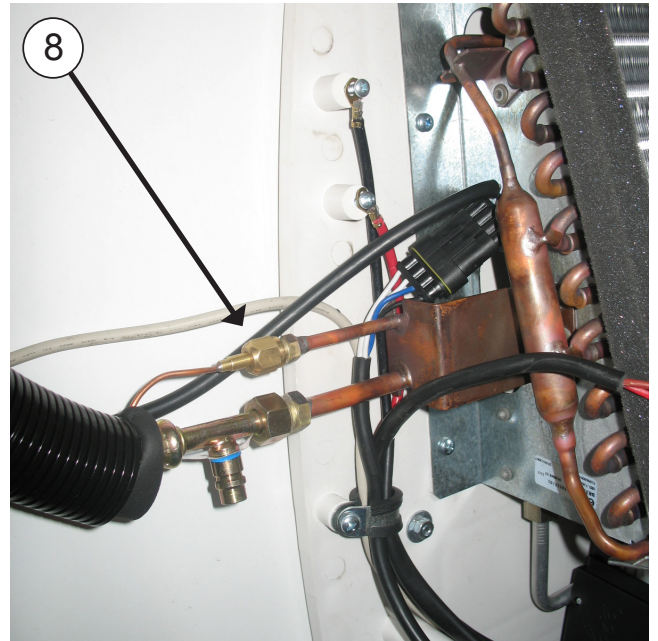

9 Présenter le protecteur de tuyaux avec joint, marquer et percer à Ø4 puis fixer avec des vis taraudeuse à tôle 4,8x19mm.



10

Coller les supports en plastique et fixer la tuyauterie, les câblages et le tuyau d'évacuation (nettoyer zone de montage).



11

Placer vanne de drainage.



12

Ouvrir la grille avant et démonter les couvercles de connexions et de passage des câblages originaux (*)

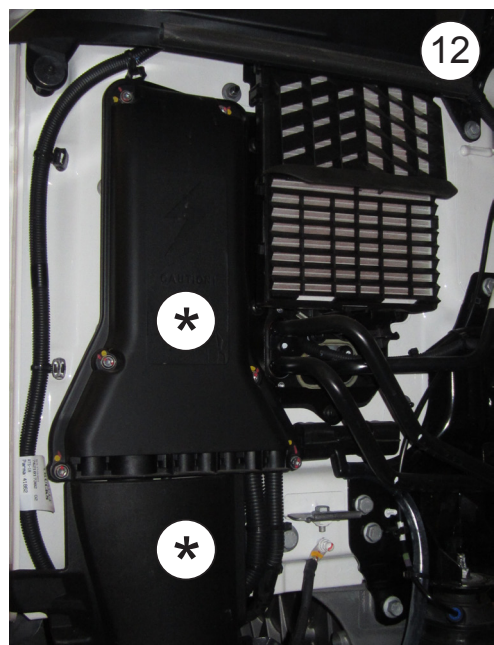

13

Connecter le câblage aux prises originales de (+) et (-) et le passer avec les câbles d'origine. Fixer le fusible au câblage original para une bride. Remonter les couvercles d'origine.

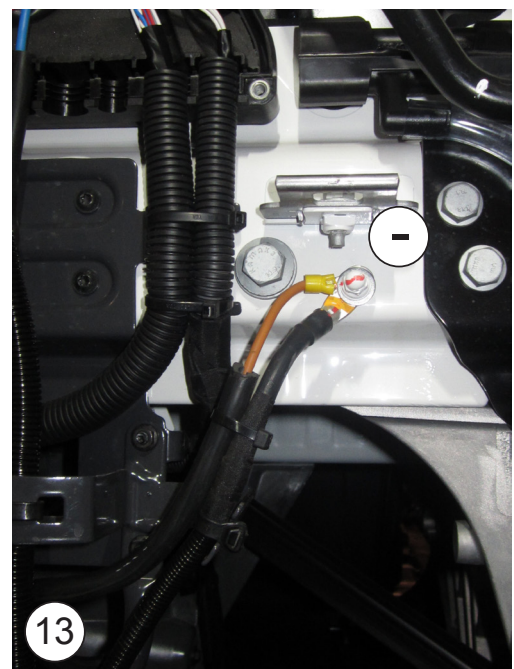
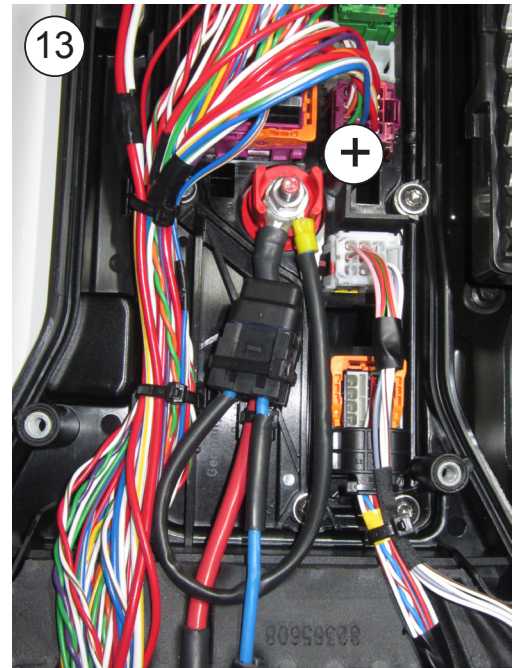
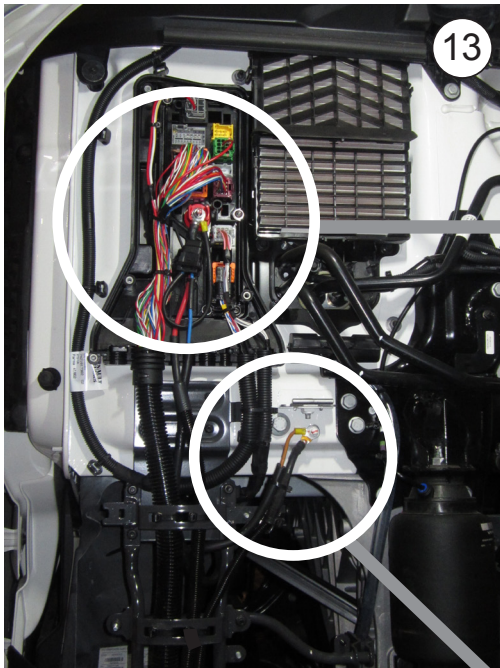

14

Abattre la cabine et passer le câblage à travers la zone la plus adéquate vers l'unité condensatrice. Fixer avec des serre-câbles ou des brides.

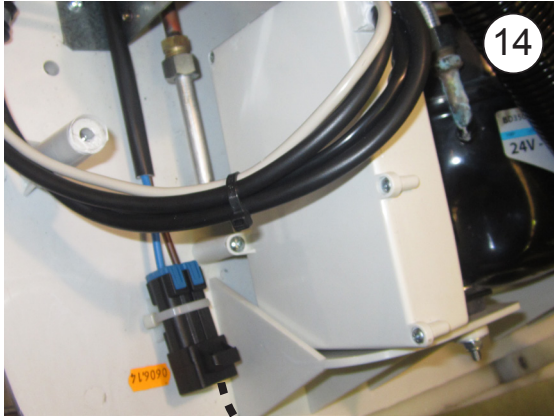

14

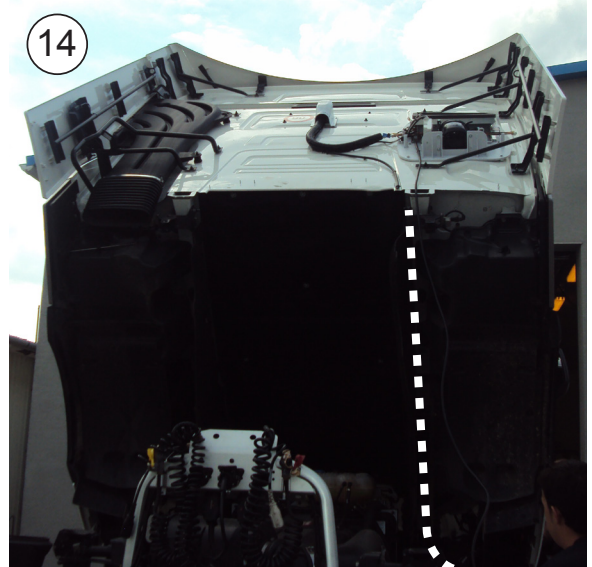

14

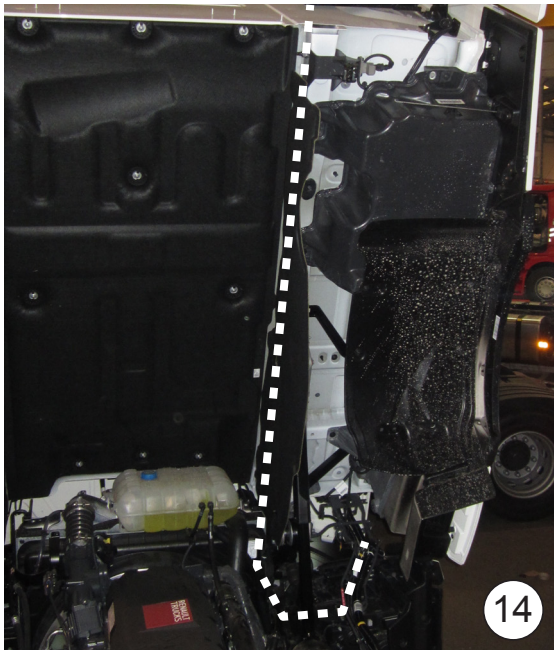

14



14

*

Démonter le protecteur (*) et passer le câblage sous le protecteur.

15

Connecter le câblage d'alimentation à l'unité.
 (-) = câbles M et N.
 (+) = câbles R et Az.

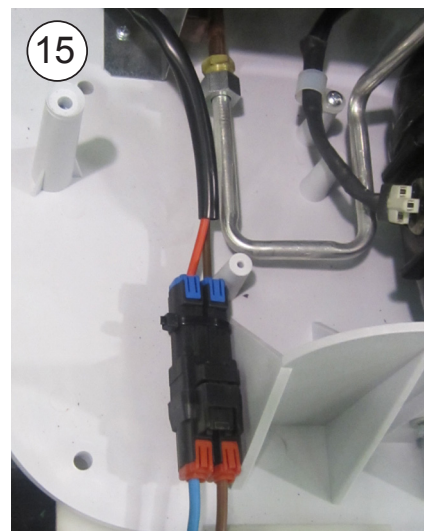

15

16

Placer le couvercle à vis démonté précédemment.

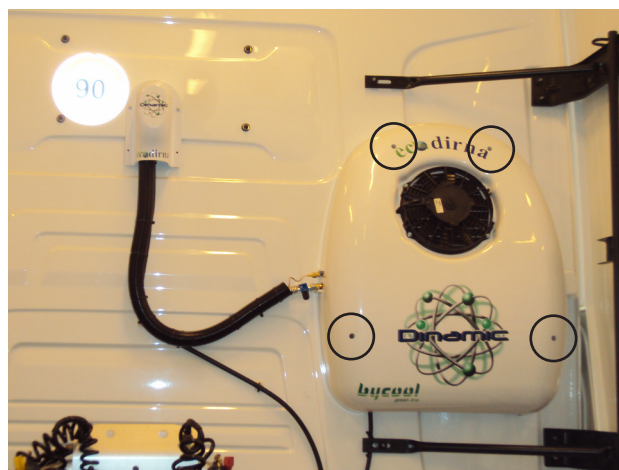
**17**

Placer le couvercle de protection de raccords avec des vis taraudeuses à tôle 3,1x 11 du côté opposé à la tuyauterie.

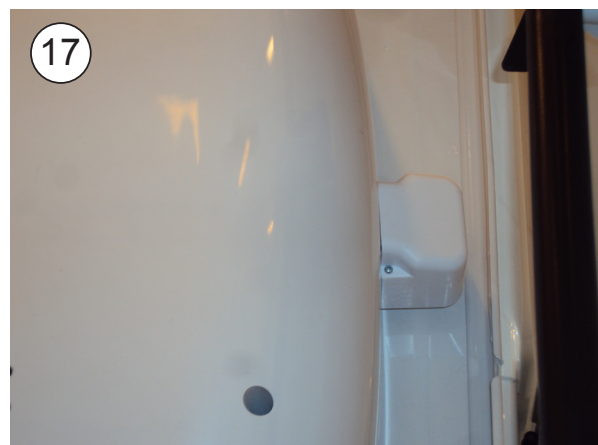
**CHARGE DE GAZ:****18**

Vider le circuit durant au moins 30 minutes.

19

Introduire 300 gr de charge de gaz R134a et mettre l'équipement en marche.

20

VUE GENERALE DE L'UNITÉ DE CONDENSATION ET TUYAUTÉRIE.

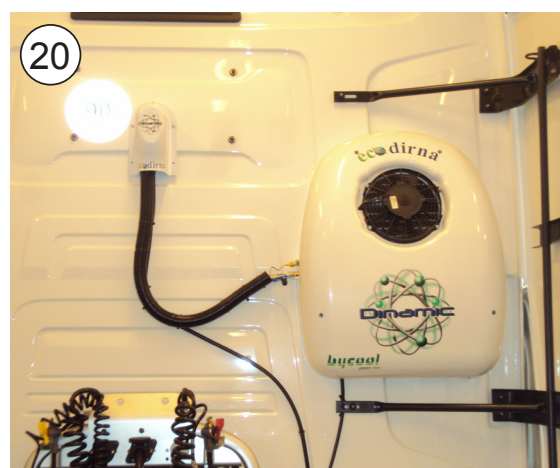

21

VISTA GENERAL DE LA UNIDAD
EVAPORADORA.



Schéma électrique

AVIS IMPORTANT!

Attention de ne pas inverser les polarités au moment de connecter l'alimentation à l'équipement. Si cela se produisait, la plaque de commande ne s'allumerait pas et l'équipement ne fonctionnerait pas.

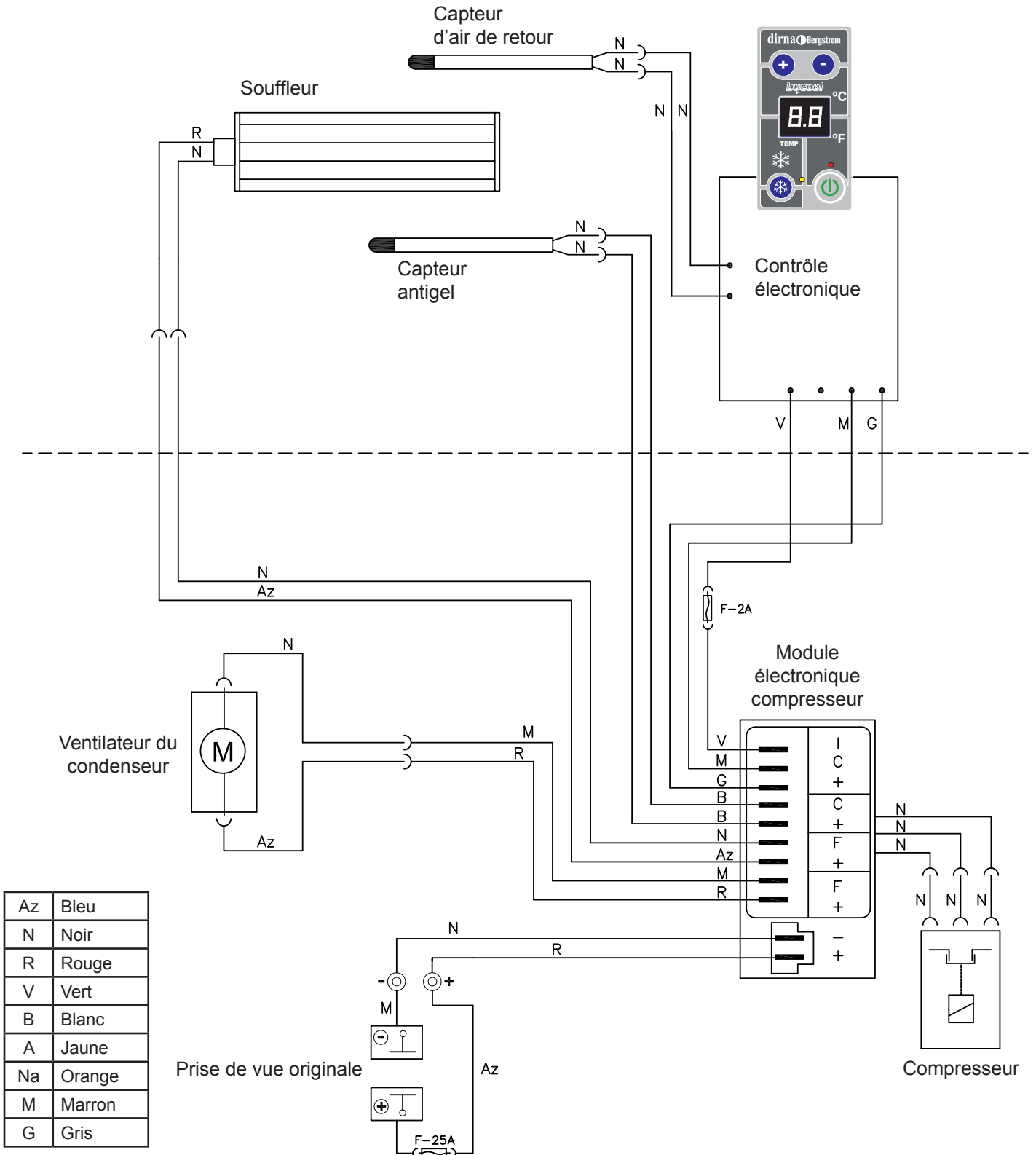

A series of horizontal dotted lines for writing, spanning the width of the page.

Empfehlungen Zur montage

- Vor und während der Montage bitte diese Anweisungen lesen und beachten.
- Benutzen Sie für jeden Arbeitsschritt die geeigneten Werkzeuge.

Elektrizität

- Zündschlüssel abziehen.
- Vor Montagebeginn die Batterie abklemmen.
- Den ordnungsgemäßen Anschluss und die korrekte Installation der Elektrokomponenten überprüfen.

Achtung

Sollte das Gerät während des Einbaus ins Schwanken geraten oder die Kabine umkippen, muss man von dem Moment, wo sich das Gerät wieder in waagerechter Stellung befindet, mindestens 60 Minuten abwarten bis es in Betrieb genommen werden kann.

Mitgelieferte unterlagen

Montageanweisungen	1002435861
Benutzerleitfaden	1002430924
Fehlerdiagnose	1002430925
Ersatzteilliste	1002435862

Angaben zur Position:
RECHTS: Beifahrerseite
LINKS : Fahrerseite

Anzugsdremoment (N.m)

Gewinde	Stahlqualität		Maulweite
	8.8	10.9	
M6/100	10	13	10

Schläucheanleitung

Fitting Driving Torque

Schläuche	Fitting Driving Torque	Werkzeug
1/4"	13-15	Llave fija 14 mm
3/8"	15-17	Llave fija 19 mm

Werkzeuge

- Knarre mit Absperrhahn 10
- Kreuzschraubendreher TOP 10
- Schraubenschlüssel 10, 11, 14, 17, 19
- Innensechskantschlüssel 6
- Rohrschlüssel Ø10
- Bohrer Ø 4, 6
- Bohrmaschine
- Kreissäge Ø 19, 22, 48
- Schere
- Nietmaschine M6

Symbologie



Fragile



Attention aux coupures !





Risque électrique

Documentation included

Kurzführer	1002430934
Garantie	220AA10017

Warnhinweise

 Der Installateur muss im Bereich Fahrzeug-Klimaanlagen ausreichend geschult sein.

 **dirna Bergstrom, s.l.** übernimmt keine Verantwortung für Schäden oder Brüche aufgrund einer nicht ordnungsgemäßen Installation oder Bedienung des Geräts oder den Austausch von Teilen bzw. Umbauten, die ohne die erforderliche schriftliche Genehmigung durchgeführt wurden.

 **In den Kühlkreis zu leitende Füllmenge Kühlgas R-134a: 300 g**

 Siehe **Garantieverfahren** des Produkts in der **Fehlerdiagnose**.

 Siehe Benutzerleitfaden des Geräts für den ordnungsgemäßen Betrieb der Fernbedienung und des Bedienfelds.

 Die folgenden Unterlagen müssen dem Benutzer nach der Installation ausgehändigt werden: **Benutzerleitfaden, Garantie und Fehlerdiagnose**.

VORBEREITENDE TÄTIGKEITEN:

- Batterie abschalten.
- Annere Luftverteiltertafel des Verdampfers abnehmen.

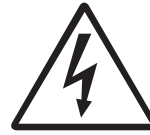

1

AUF DER KABINENINNENSEITE:

Mitgelieferte Vorlage auflegen und Bohrlöcher markieren.

Option A: Sollten 2 Betten vorhanden sein, die Vorlage zwischen beiden anbringen.

Option B: Ist nur 1 Bett vorhanden, Vorlage über diesem auflegen.

Option C: Vorderes Handschuhfach Bett abnehmen, Vorlage auflegen.

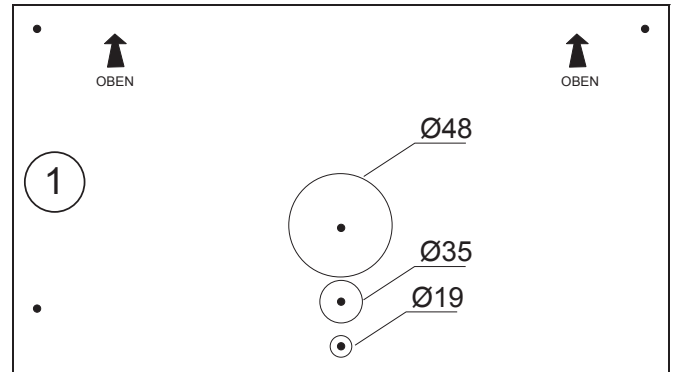

2

Durchgangsbohrung Ø4 mit langem Bohrer in Position der Bohrung Ø48 durchführen, danach die folgenden Bohrungen durchführen.

- A- (1) Ø 35 nur im Bezug durchführen.
- B- (1) Ø 19 nur im Bezug durchführen.
- C- (1) Ø 48 nur im Bezug durchführen.
- D- (4) Ø 22 nur im Bezug durchführen.

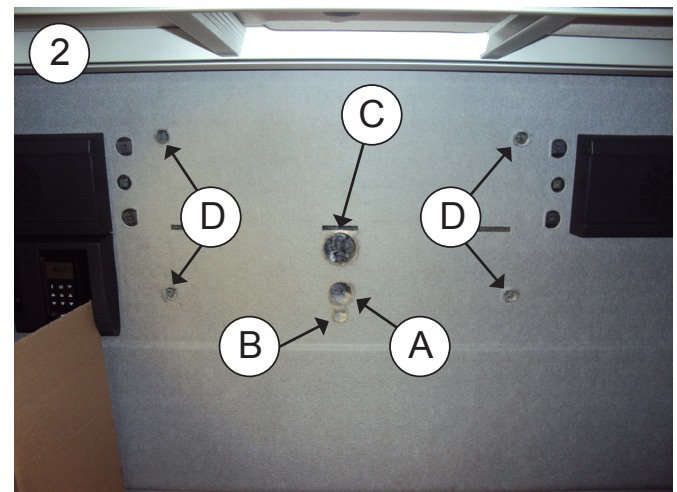
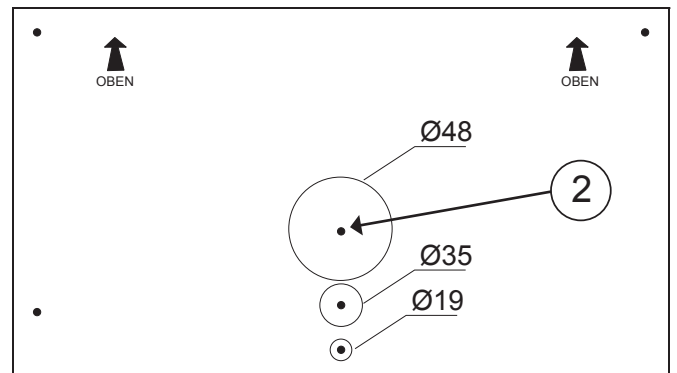

3 AUF DER KABINENAUSSENSEITE:

Vorlage auf gleicher Höhe von der Außenseite auflegen, dabei als Referenz die durchgeführte Ø4 Bohrung nehmen, markieren und die restlichen Bohrungen durchführen.

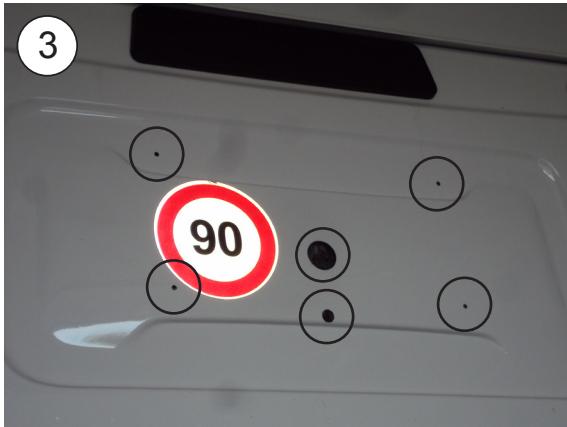
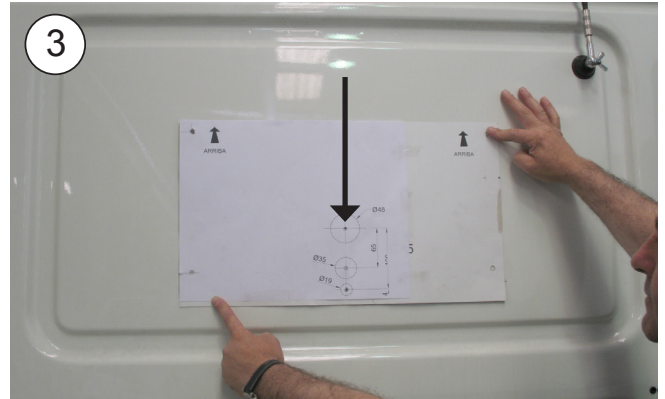

4 Von Innen her Stiftschrauben M6 mit Mutter und Unterlegscheibe wie angegeben einführen.

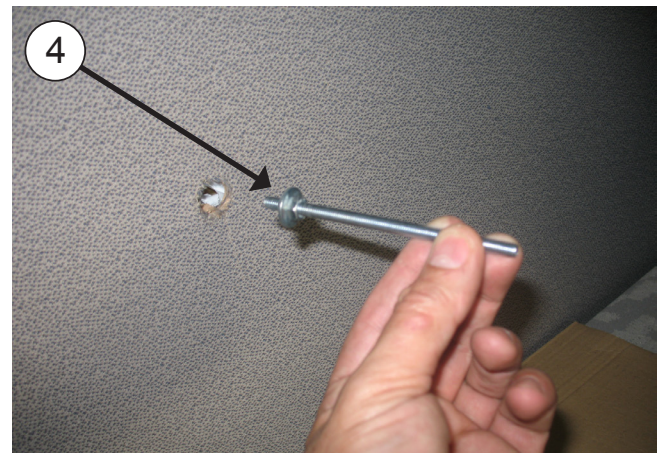

5 Von Außen her mit Gummiunterlegscheibe, Flachscheibe und selbstsichernder Spannmutter befestigen, dabei von Innen her mit Rohrschlüssel 10 halten.

6 Mutterkappen und Wanddurchführung anbringen.

7 Abflussschlauch durch Bohrung Ø19, und Wanddurchführung ins Innere der Kabine führen.

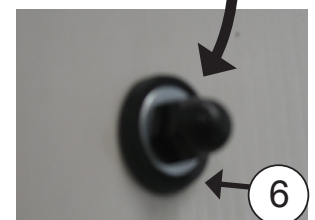
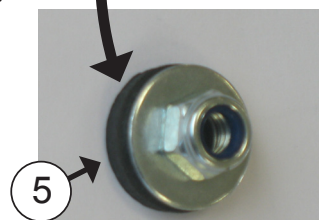
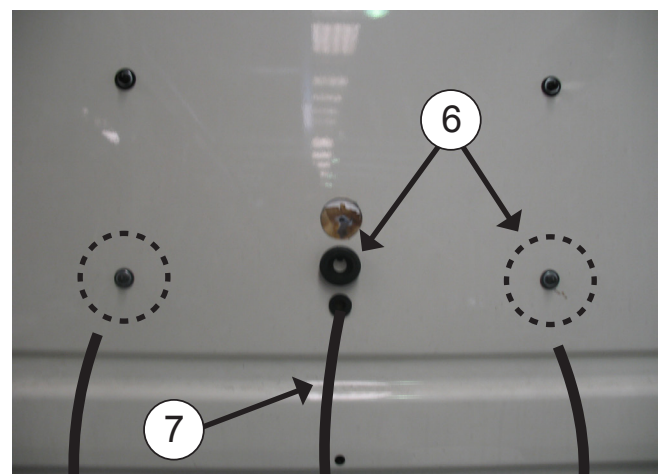

8 (3) Muttern M6 mit (3) Flachscheiben auf die Stiftschrauben schrauben, wobei die Flachscheiben sich auf Höhe des Bezugs befinden müssen.
SIE BEILIEGENDE ZEICHNUNG

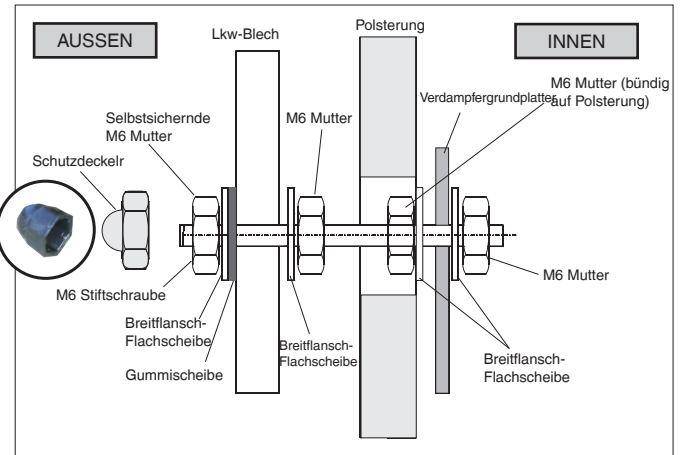

 **WICHTIGER HINWEIS**
 Bei schrägen Bezügen muss die Verdampfergruppe senkrecht oder schräg von unten nach außen liegen, damit das Kondenswasser nicht auf den Bezug läuft.

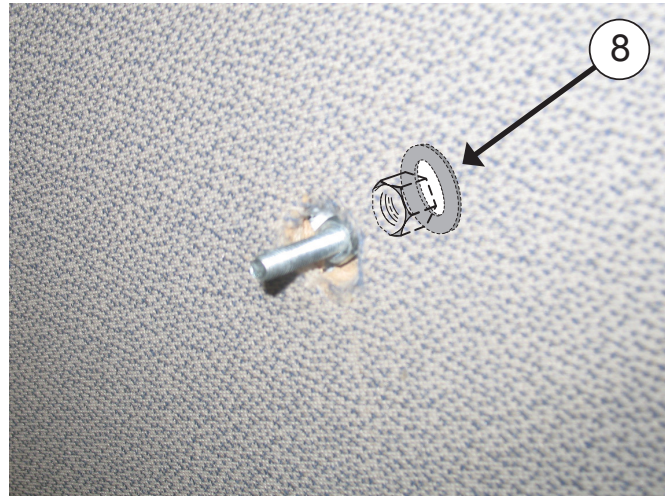
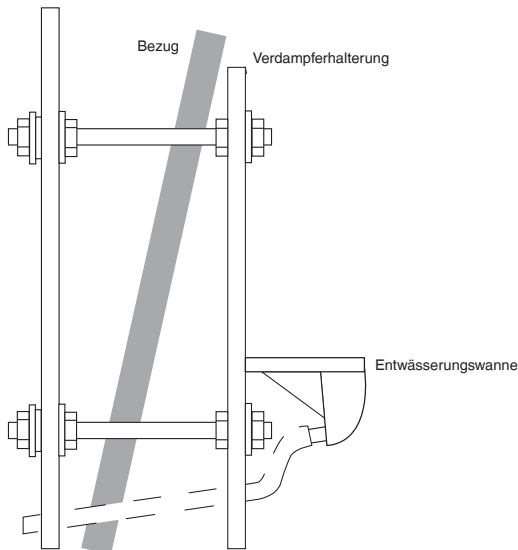

9 Entwässerungsleitung durch das Bohrloch der Verdampfergrundplatte führen und an die Entwässerungswanne anschließen.

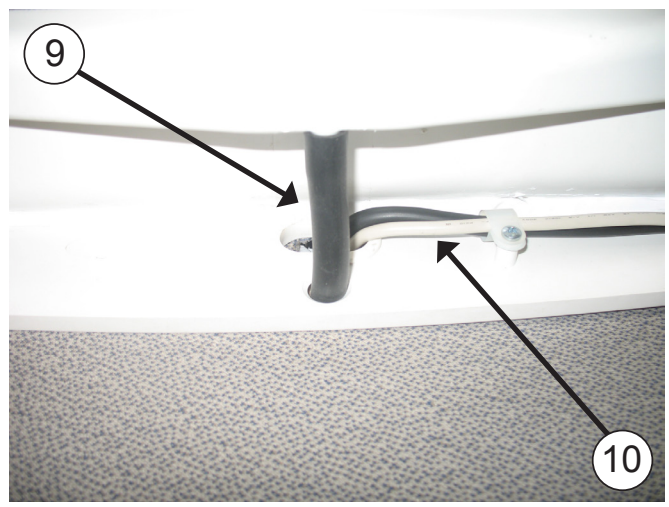

10 Kabel durch die Bohrung Ø 35 nach Außen führen.



11 Verdampferbasis auf Stiftschrauben stellen und mit (4) Grower-Scheiben (4) und (4) Muttern M6 befestigen.

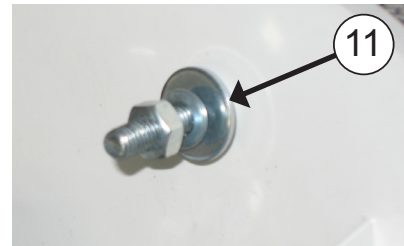
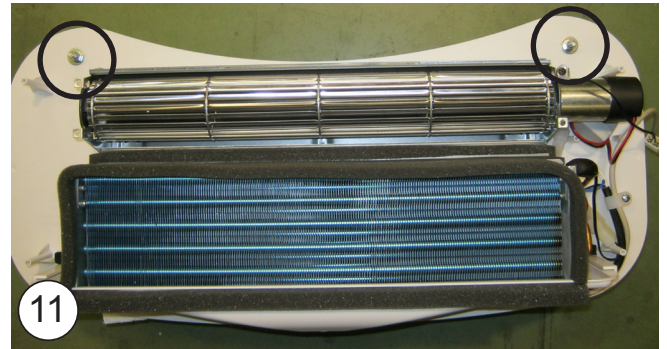
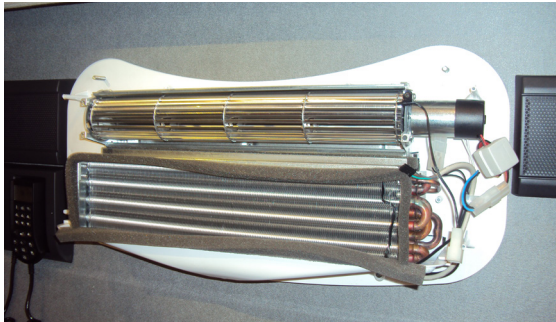

 **WICHTIGER HINWEIS**
Der Abfluss muss ein ausreichendes Gefälle haben, damit das Wasser nicht auf den Bezug laufen kann.

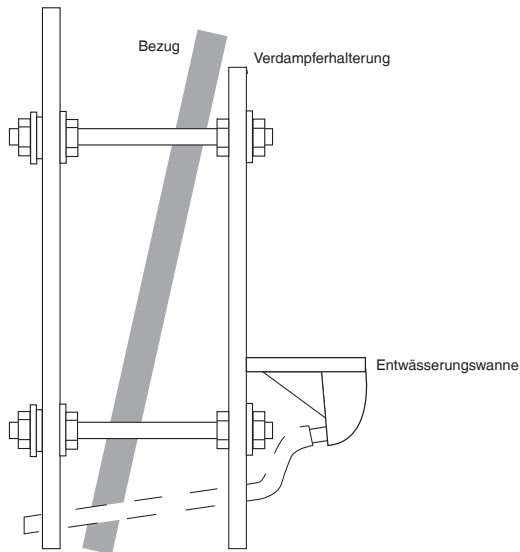

12 Rückführsonde und Kommunikationskabel anschließen.

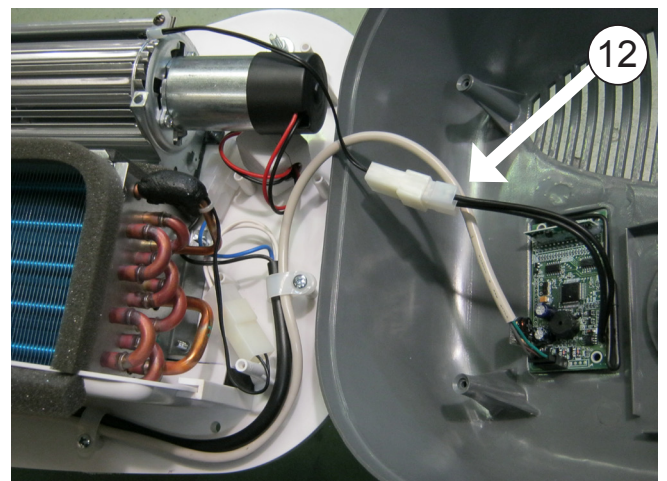

13

Innere Luftverteilertafel anhand eines Magnetschraubendrehers mit ihren Schrauben wieder anbringen und Kappen aufsetzen.



MONTAGE KONDENSATOR:

Achtung: Je nach Fahrzeug können die Ausgänge der Schläuche rechts oder links angebracht werden.

1 Mitgelieferte Vorlage auflegen und Bohrlöcher unter Berücksichtigung der Schlauchlänge (vom Verdampfer zum Kondensator) markieren.

2 Abdeckung abnehmen und Kabel des Kondensatorlüfters lösen.



3 Bohrlöcher Ø 9 bohren und Nietmuttern einsetzen.

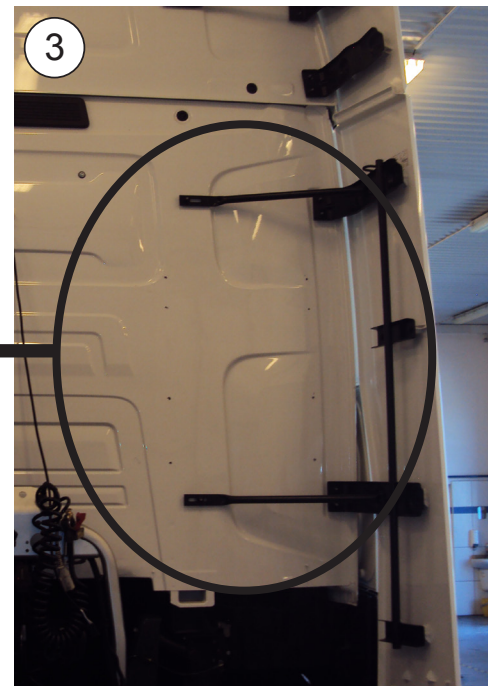

4 Wenn die Baugruppe flach aufliegt, mit (8) Schrauben 6/100X30, Grower-Scheibe und Flachscheibe befestigen.

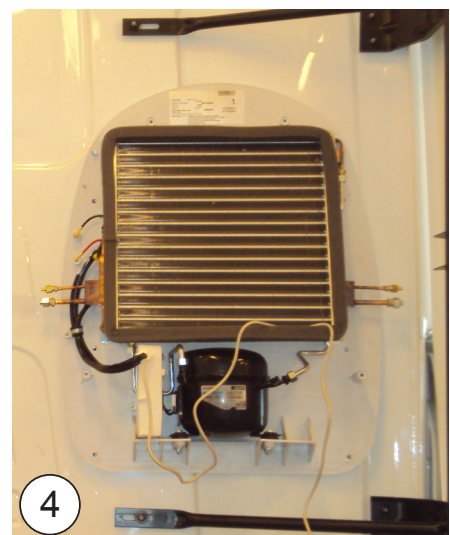

5 (*)- Ist die Unterlage nicht glatt, Distanzstück 10/20/40 mm und Schraube 6/100x40/60/70 anbringen.
SIEHE DETAILZEICHNUNG A

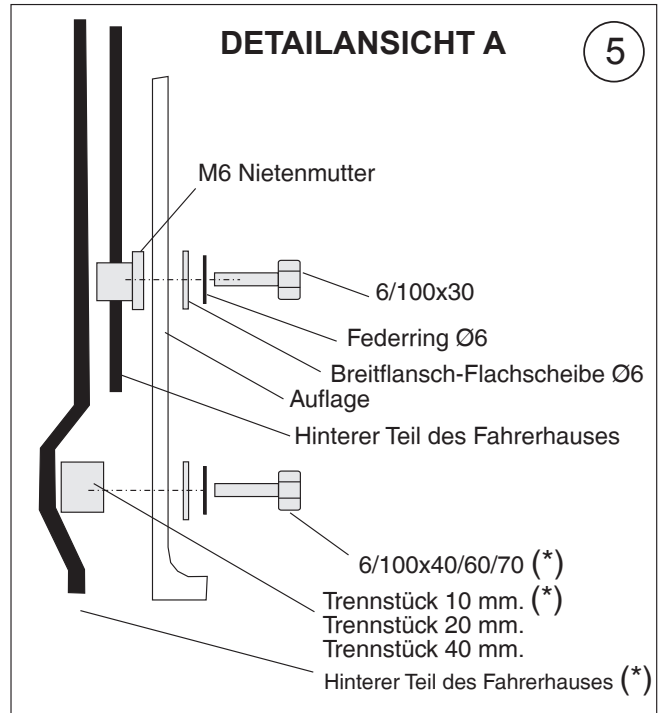

6 Wanddurchführung um die Stutzen der Kühlschlange herum anbringen.

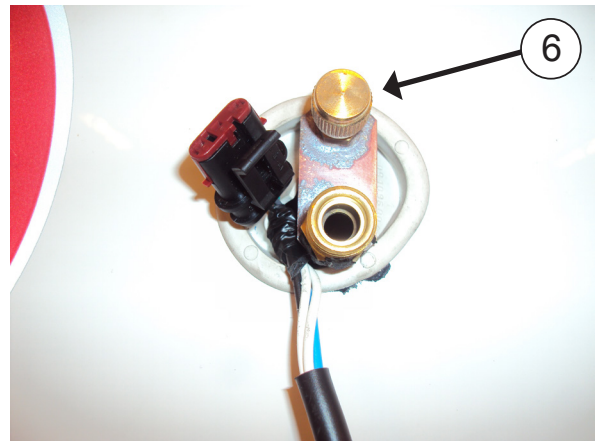

7 Kabel anschließen, Stutzen am Verdampfer anbringen und mit Tropfschutzband versiegeln.

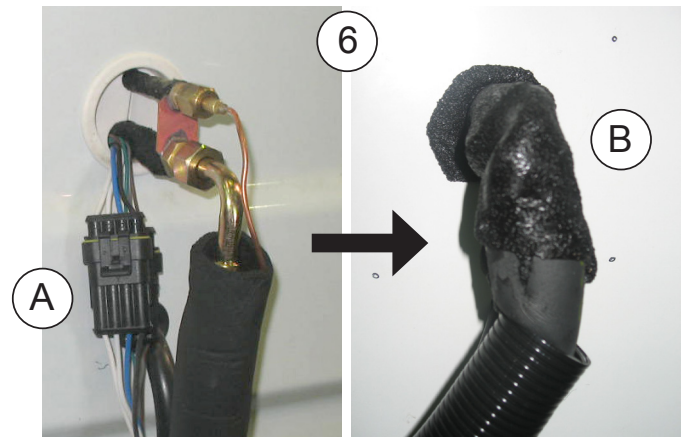

8 Schläuche und Kabel an den Kondensator anschließen.

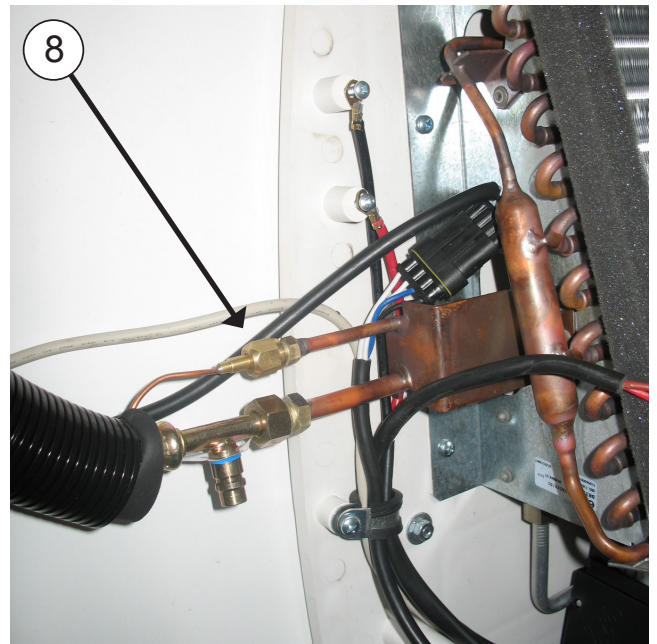

9 Schlauchschutz mit Dichtung nehmen, an Ø4 markieren und bohren und mit Blechschraube 4,8x19mm befestigen.



10

Kunststoffhalterungen ankleben und Schläuche, Kabel und Abflussschlauch befestigen (Montagebereich reinigen).

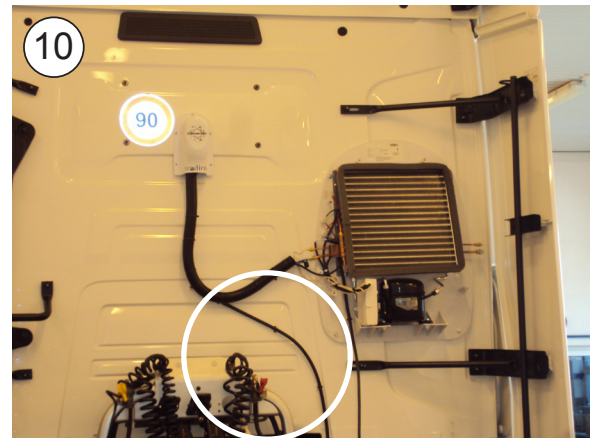

11

Drainageventil anbringen.



12

Vorderen Kühlergrill öffnen und Abdeckungen der Anschlusskästen sowie Original-Kabelführungen abnehmen (*).



13

Kabel an Originalanschlüsse (+) und (-) anschließen und zusammen mit den Originalkabeln durchführen. Sicherung mit Kabelbinder an der Originalverkabelung befestigen. Original-Abdeckungen wieder anbringen.

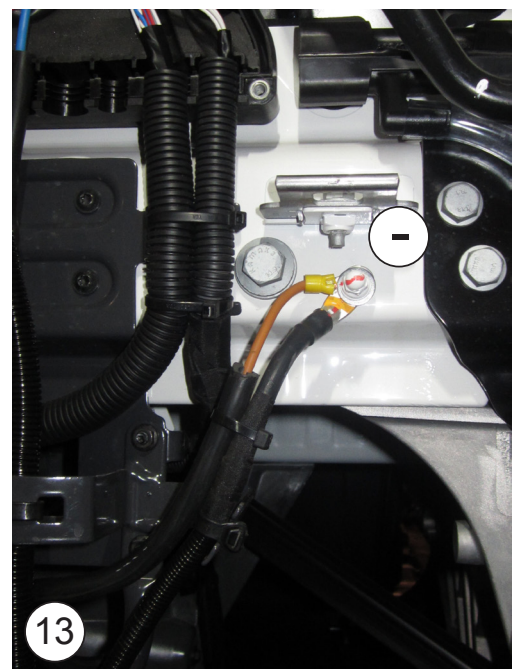
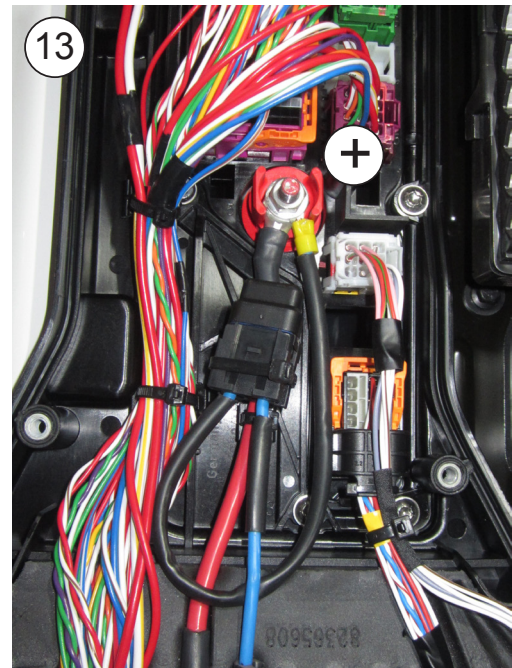
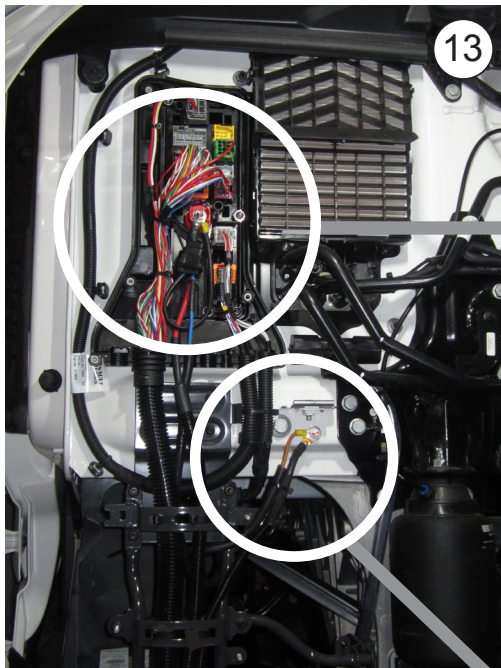

14

Kabine herunterklappen und Kabel an der günstigsten Stelle zur Kondensatorgruppe führen und mit Kabelschellen oder -bindern befestigen.

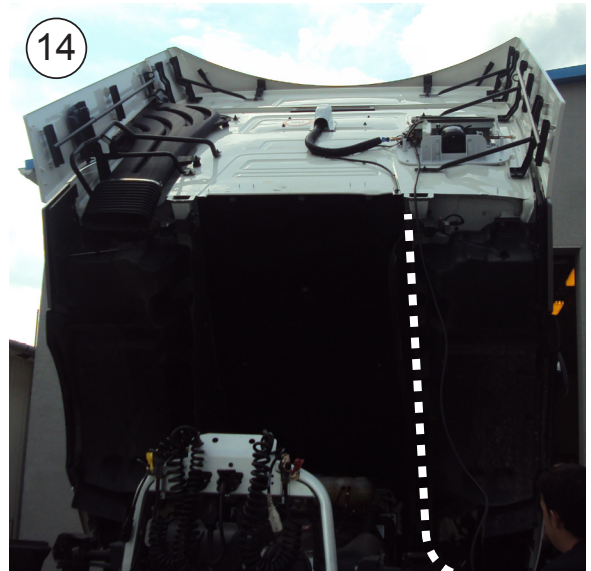
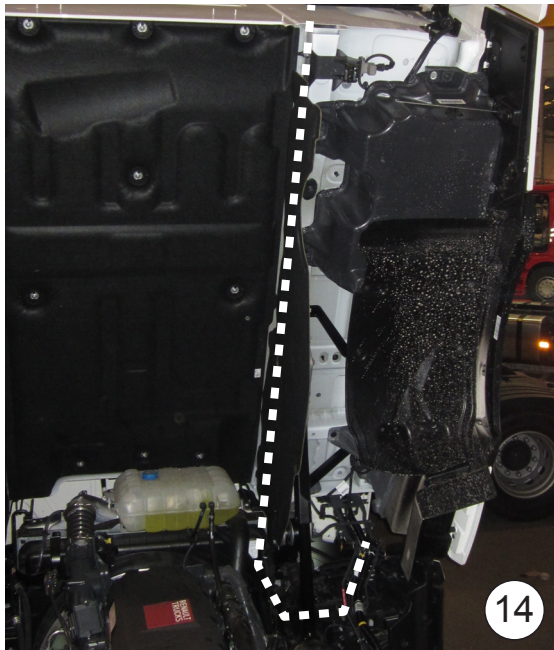
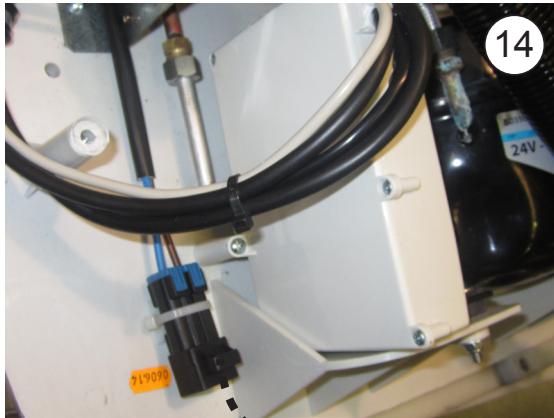

Schutzvorrichtung abnehmen (*) und Kabel unter dieser hindurchführen.

15

Speisekabel an die Baugruppe anschließen.
 (-) = Kabel M und N.
 (+) = Kabel R und Az.

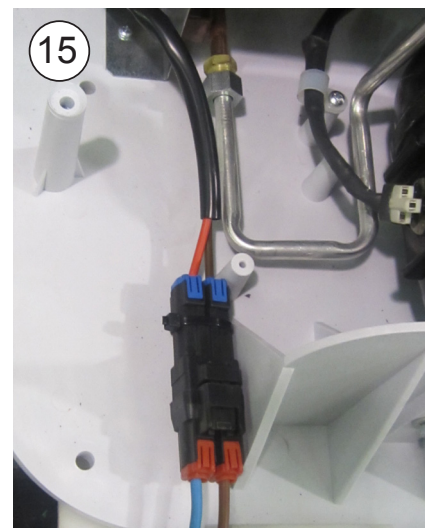

16

Abdeckung mit den zuvor abgenommenen Schrauben anbringen.



17

Stützenkappe mit Blechschrauben 3,1x 11 an der den Schläuchen gegenüberliegenden Seite anbringen.

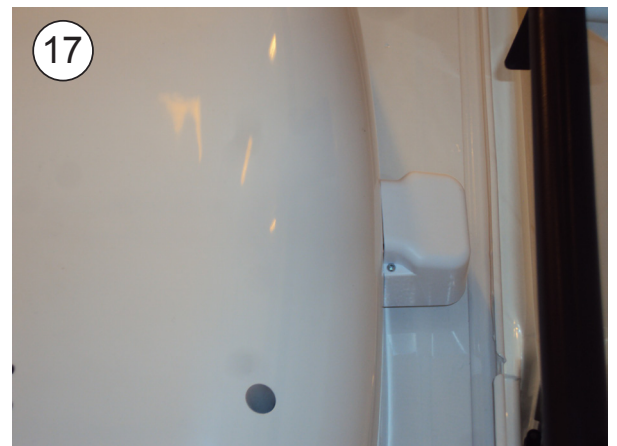

GASBEFÜLLUNG:

18

Während mindestens 30 Minuten ein Vakuum im Kreislauf herstellen.

19

Mit 300 g Gas R134a füllen und das Gerät in Betrieb nehmen.

20

ALLGEMEINER ÜBERBLICK ÜBER KONDENSATOREINHEIT UND SCHLÄUCHE.

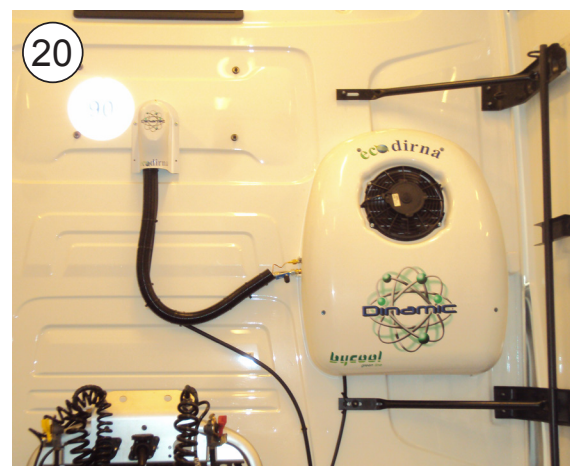

21

ANSICHT DER VERDAMPFERANLAGE.



Elektrisches schaltschema

WICHTIGER HINWEIS!

Darauf achten, dass die Polaritäten beim Anschluss der Stromversorgung an die Anlage nicht vertauscht werden. Ist dies der Fall, schaltet sich das Bedienfeld nicht an und die Anlage funktioniert nicht.

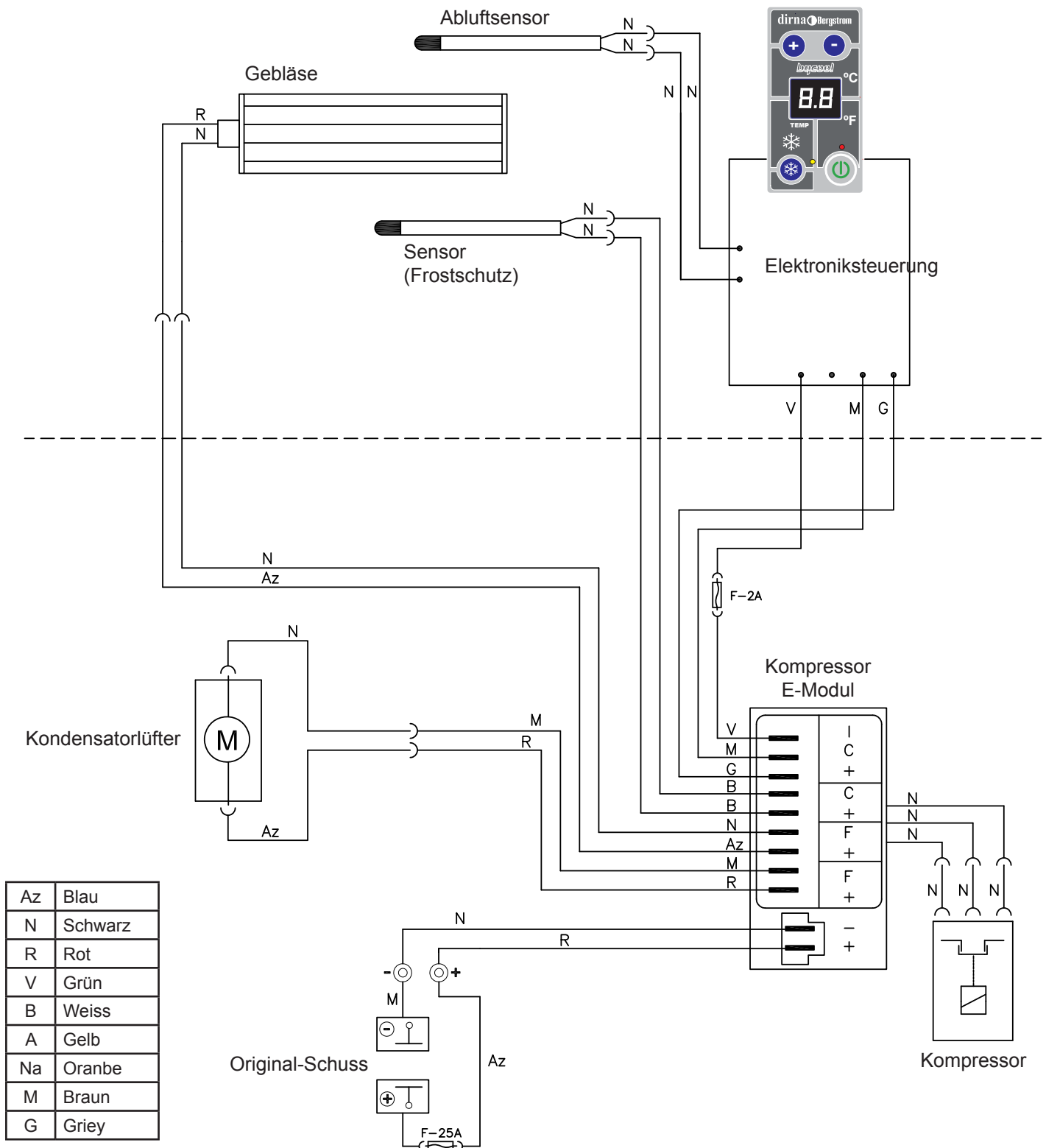

Suggerimenti per il montaggio

- Prima di cominciare il montaggio, leggere attentamente le istruzioni e rispettarle nel corso dello stesso.
- Usare gli attrezzi più adatti ad ogni operazione.

Electricidad

- Scollegare la chiave di contatto.
- Scollegare la batteria prima di cominciare il montaggio.
- Assicurarsi di aver effettuato correttamente l'installazione e il collegamento dei componenti elettrici.

Attenzione

Se durante il montaggio si inclina l'impianto o si ribalta la cabina con l'impianto montato, prima di rimettere in funzione l'impianto occorre attendere almeno 60 minuti dal momento in cui è di nuovo in posizione orizzontale.

Documentazione correlata

Istruzioni di montaggio	1002435861
Guida dell'utente	1002430924
Soluzione dei problemi	1002430925
Elenco ricambi	1002435862

Le indicazioni relative alla posizione sono:

DESTRA: lato del passeggero

SINISTRA: lato dell'autista

Coppia di serraggio (N.m)

Filettatura	Qualità Acciaio		Chiave
	8.8	10.9	
M6/100	10	13	10

Montaggio da tubi

Coppia di serraggio

Tubi	Coppia di serraggio	Strumenti
1/4"	13-15	Chiave fissa da 14 mm
3/8"	15-17	Chiave fissa da 19 mm

Attrezzi

Chiave a cricchetto con rubinetto di intercettazione da 10

Cacciavite a stella TOP 10

Chiave fissa da 10, 11, 14, 17, 19

Chiave a brugola da 6

Chiave a tubo da Ø 10

Punta Ø 4, 6

Trapano

Sega circolare Ø 19, 22, 48

Forbici

Rivettatrice M6

Simbologia



Fragile



Attenzione alle mani





Tensione elettrica pericolosa

Documentazione allegata

Guida veloce	1002430934
Garanzia	220AA10017

Avvertenze

 L'installatore deve essere in possesso della formazione necessaria in materia di aria condizionata per veicoli.

 **dirna Bergstrom, s.l.** declina ogni responsabilità per danni o rotture derivanti dall'errata installazione o dall'errato uso dell'impianto o da sostituzioni o modifiche effettuate senza la necessaria autorizzazione per iscritto.

 **Quantità di carica di gas refrigerante R-134a, da immettere nel circuito: 300 g.**

 Vedi la **procedura di garanzia** del prodotto in **Diagnosi dei problemi**.

 Vedi la **Guida dell'utente** dell'impianto per il corretto funzionamento del telecomando e del pannello di controllo.

 I seguenti documenti devono essere consegnati all'utente una volta conclusa l'installazione: **Guida dell'utente**, **Garanzia** e **Diagnosi dei problemi**.

OPERAZIONI PRELIMINARI:

- Disinserire la batteria.
- Smontare il pannello interno di distribuzione dell'aria dell'unità evaporante.



1

DALL'INTERNO DELLA CABINA:

Posizionare la dima in dotazione e segnare i fori da eseguire.

Opzione A: In presenza di 2 cuccette, posizionare la dima tra entrambe.

Opzione B: In presenza di 1 cuccetta, posizionare la dima sulla stessa.

Opzione C: Smontare il vano portaoggetti inferiore della cuccetta e posizionare la dima.

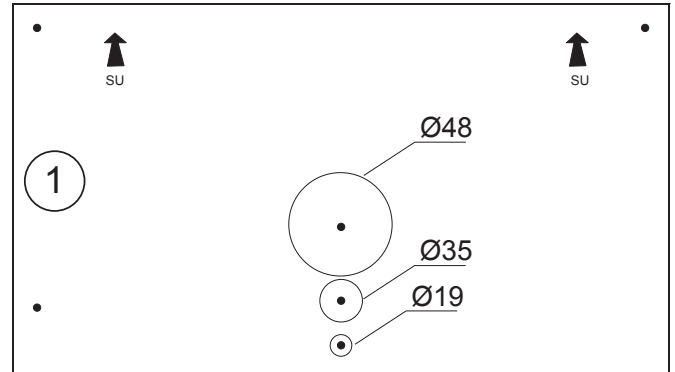

2

Praticare un foro Ø 4 passante con punta lunga nella posizione di foro Ø 48, quindi eseguire i seguenti fori:

- A- (1) Ø 35 solo nella tappezzeria.
- B- (1) Ø 19 solo nella tappezzeria.
- C- (1) Ø 48 solo nella tappezzeria.
- D- (4) Ø 22 solo nella tappezzeria.

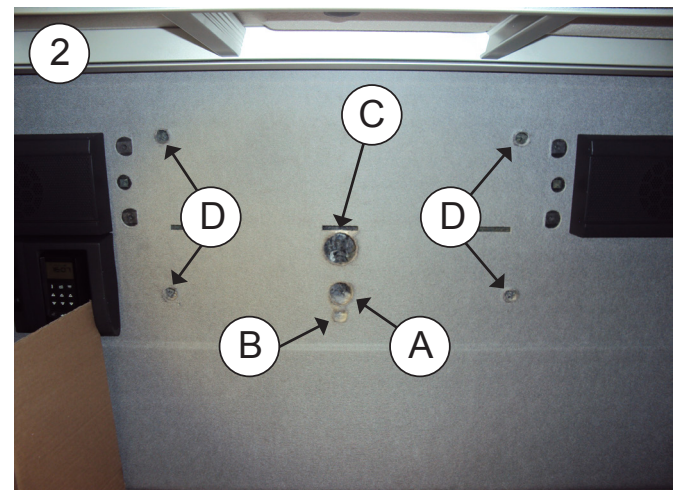
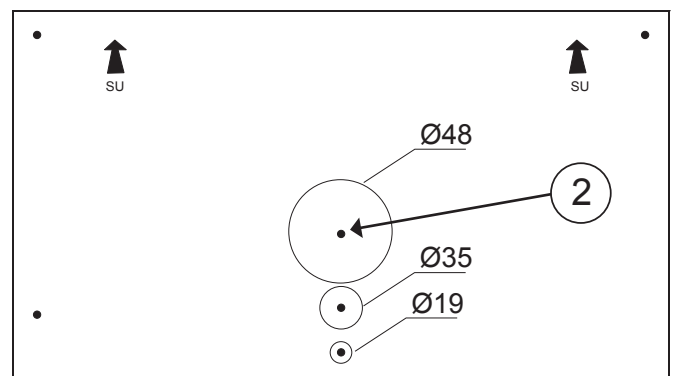

3 DALL'ESTERNO DELLA CABINA:

Posizionare la dima livellata all'esterno, prendendo come riferimento il foro effettuato $\varnothing 4$, quindi segnare ed eseguire i fori rimanenti.

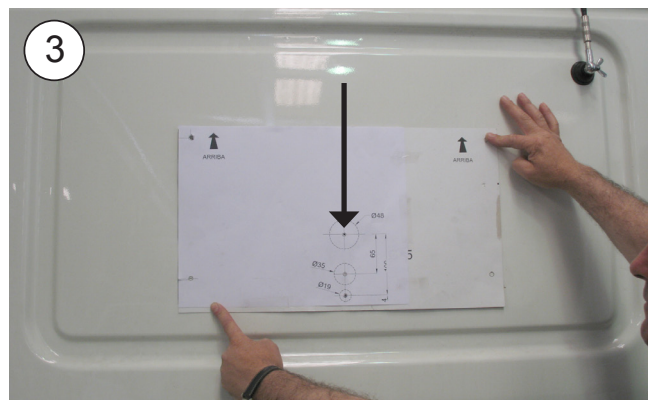
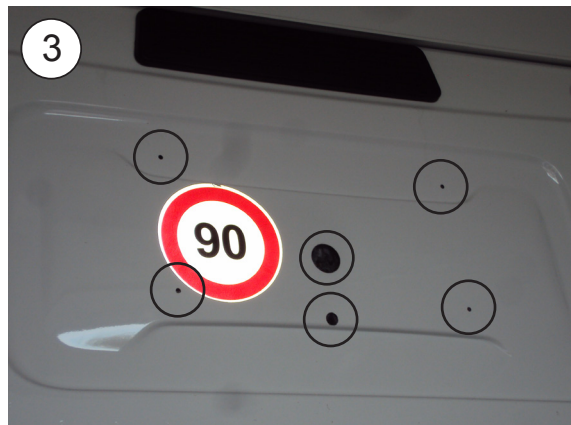

4 Inserire dall'interno le viti prigioniere M6 con il dado e la rondella, come indicato.



5 Fissare dall'esterno con la rondella piana di gomma e il dado autobloccante stringendo dall'interno con la chiave a tubo 10.

6 Inserire i tappi del dado e le guaine passamuro.

7 Fare passare il tubo di scarico nel foro $\varnothing 19$, nella guaina passamuro, verso l'interno cabina.

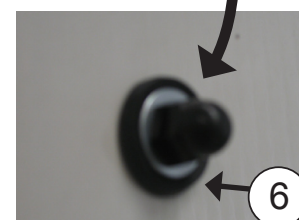
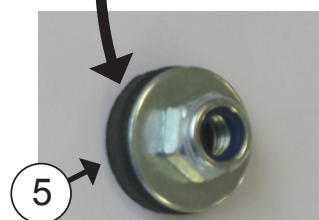
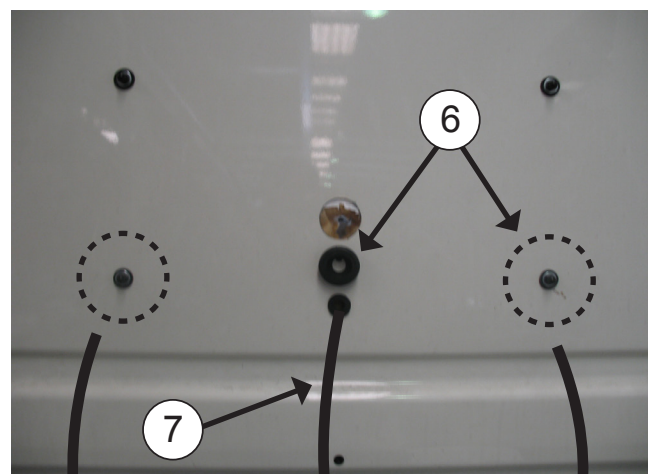

8 Sulle viti prigioniere avvitare (3) dadi M6 con (3) rondelle piane Ø 6 finché queste ultime non sono a filo della tappezzeria.
VEDI SCHEMA ALLEGATO

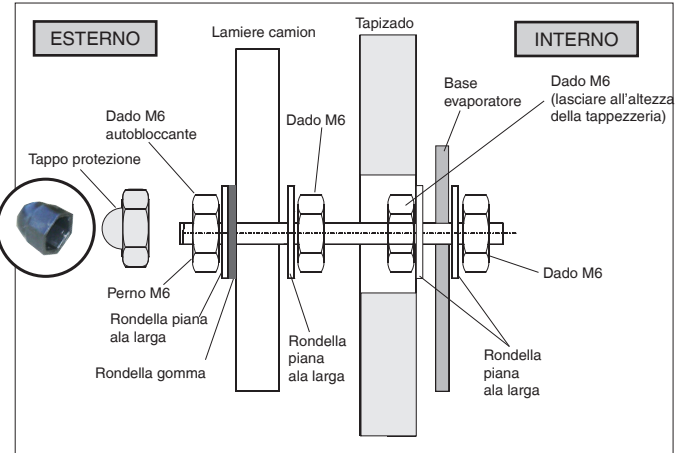

NOTA BENE
 In caso di rivestimenti inclinati tappezzati, l'insieme dell'evaporatore deve essere installato verticale o inclinato con la parte inferiore sporgente per evitare che l'acqua di condensa cada sulla tappezzeria.

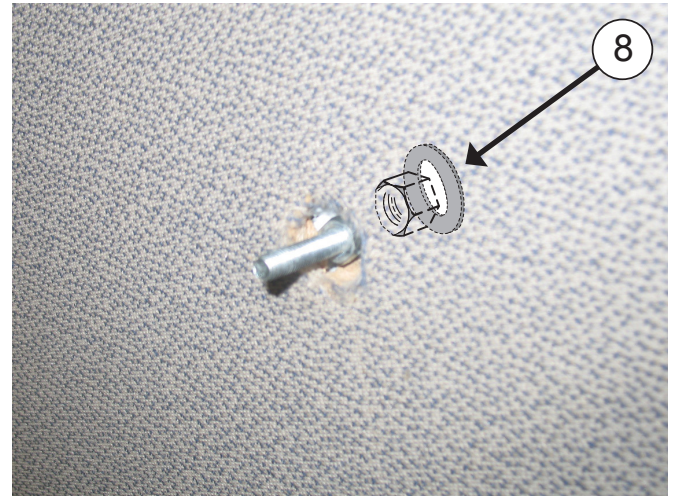
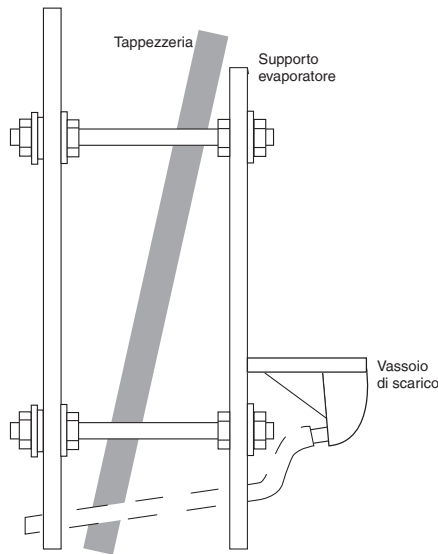

9 Far passare il tubo di scarico dal foro della base dell'evaporatore e collegare alla vaschetta di scarico.

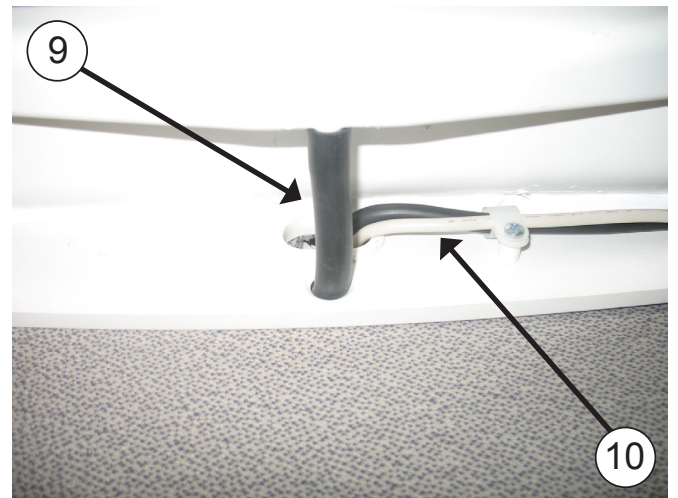

10 Fare passare il cablaggio nel foro Ø 35 verso l'esterno.



11 Inserire la base dell'evaporatore sulle viti prigioniere e fissare con (4) rondelle piatte (4) grower e (4) dadi M6.

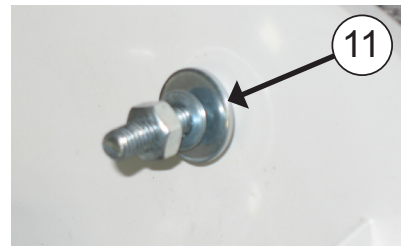
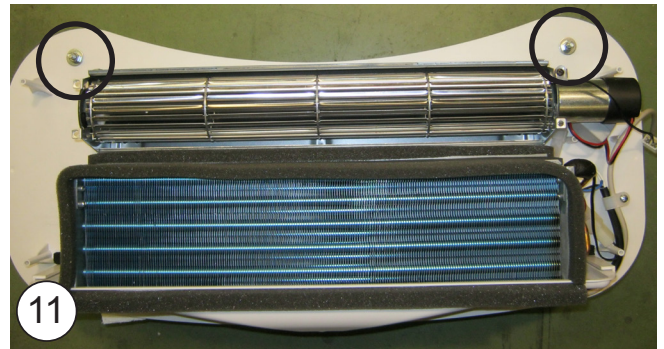
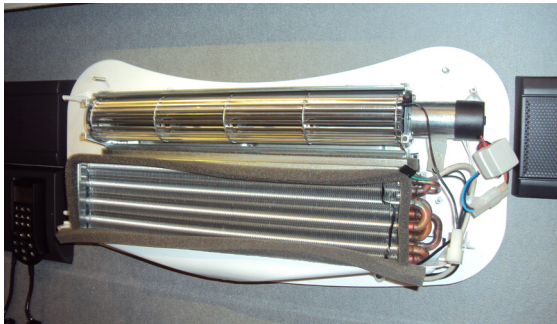

NOTA BENE

Lo scarico deve avere la pendenza sufficiente per evitare la caduta dell'acqua sulla tappezzeria.

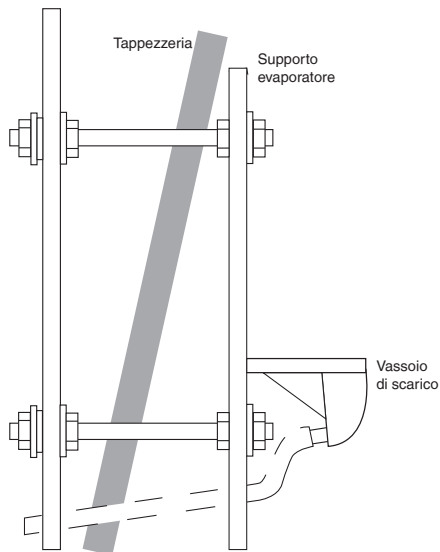

12 Collegare la sonda di ricircolo e il cavo per comunicazioni.

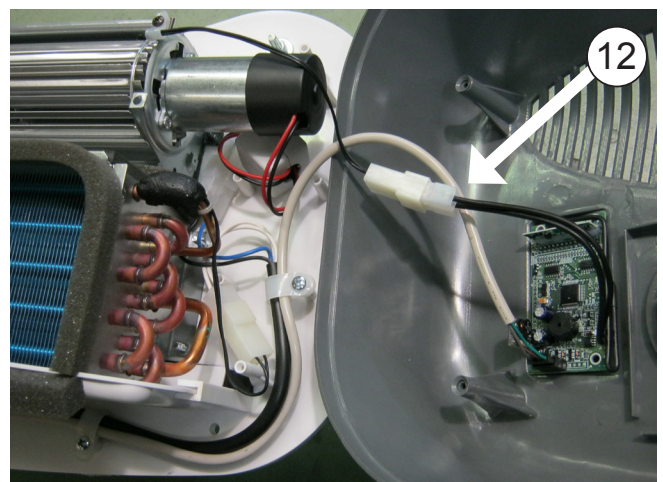

13

Fissare il pannello interno di distribuzione dell'aria con le relative viti, usando un cacciavite calamitato e inserire i tappi.



MONTAGGIO DEL CONDENSATORE:

Nota bene: A seconda del veicolo, è possibile posizionare le uscite delle tubazioni sul lato destro o su quello sinistro.

1 Posizionare la dima in dotazione e segnare i fori tenendo conto della lunghezza del tubo (dall'evaporatore al condensatore).

2 Smontare il coperchio e staccare il cablaggio del ventilatore del condensatore.

3 Praticare i fori di $\varnothing 9$ e inserire i dadi a rivetto.

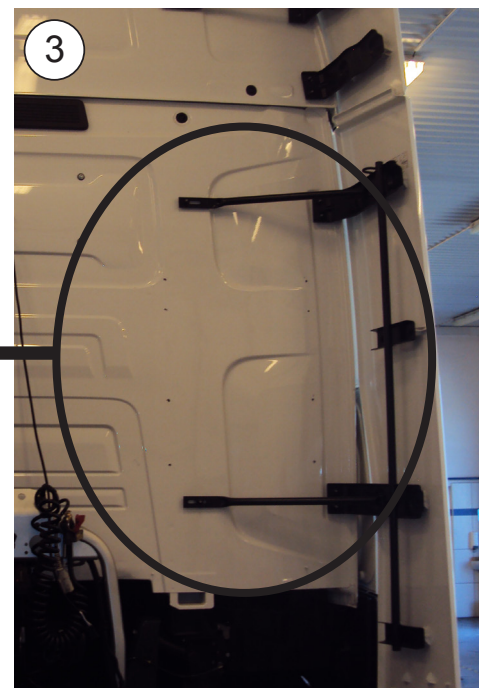

4 Fissare l'unità con (8) viti 6/100X30, rondella grower e rondella piana quando si appoggia in piano.

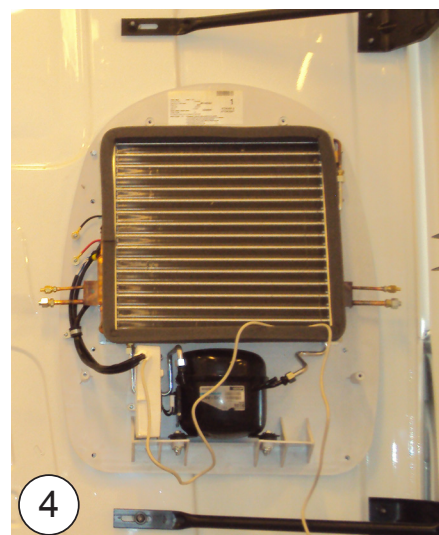

5 (*)- Se non appoggia sulla parte liscia, posizionare un separatore da 10/20/40 mm e una vite 6/100x40/60/70.
VEDI PARTICOLARE "A"

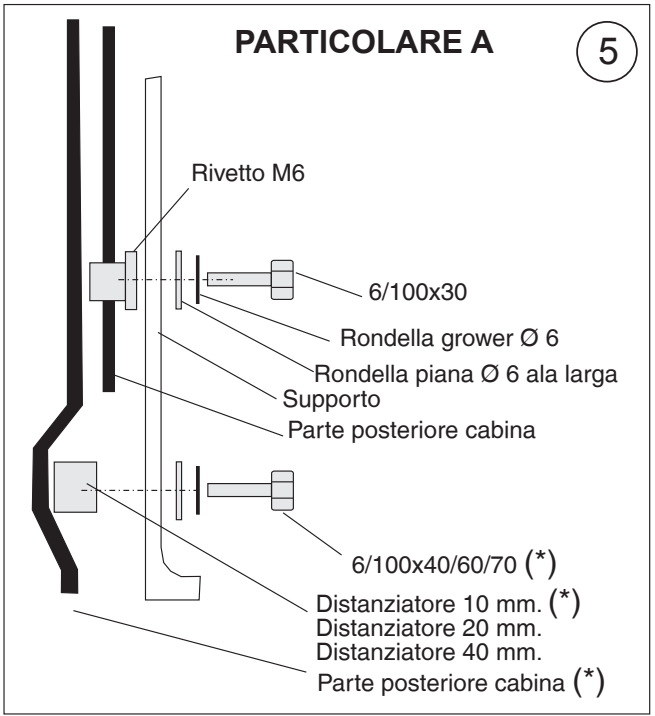

6 Inserire le guaine passamuro intorno ai raccordi della serpentina.

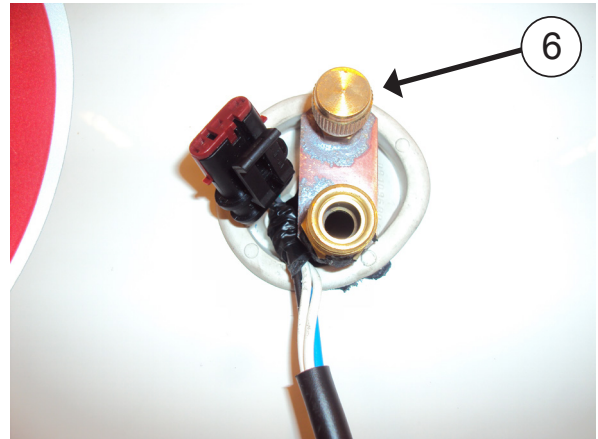

7 Collegare il cablaggio (A) e i raccordi nell'evaporatore e sigillare con il nastro a tenuta (B).

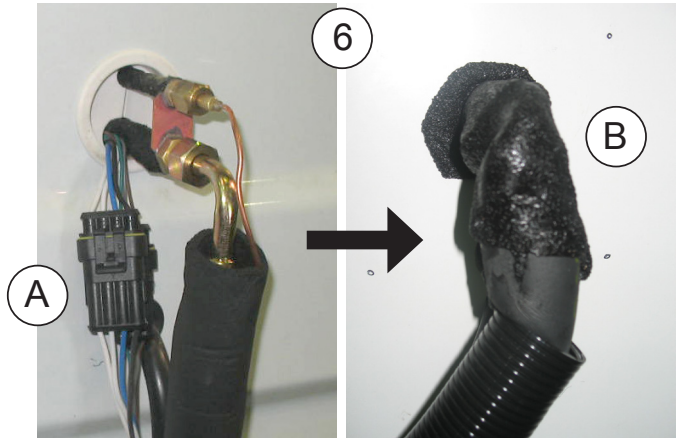

8

Collegare i tubi e il cablaggio sull'unità condensante.

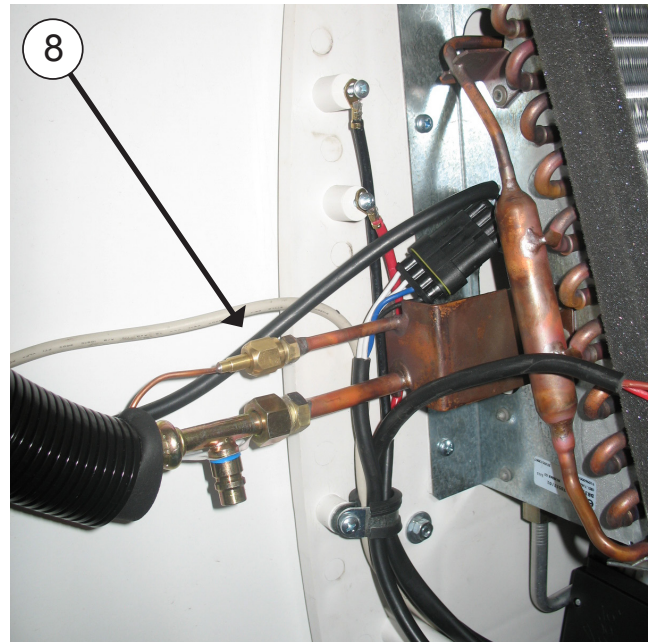
**9**

Posizionare la protezione delle tubazioni con la guarnizione, segnare e praticare fori $\varnothing 4$ e fissare con le viti autofilettanti 4,8x19 mm.



10

Incollare i supporti di plastica e fissare la tubazione, i cablaggi e il tubo di scarico (pulire la zona di montaggio).

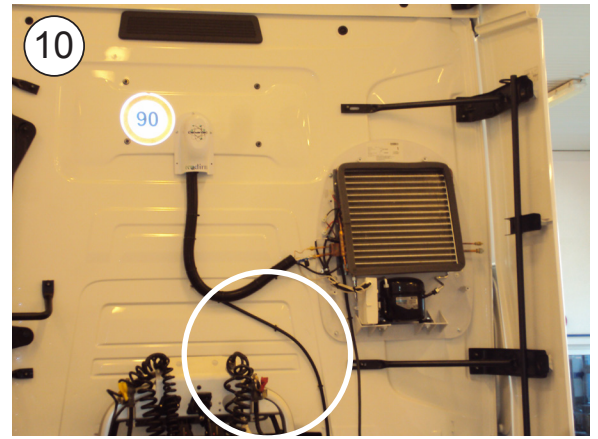

11

Inserire la valvola di drenaggio.



12

Aprire la griglia anteriore e smontare i coperchi delle connessioni e del passaggio dei cablaggi originali (*)



13

Collegare il cablaggio alle prese originali (+) e (-) e farlo passare accanto ai cablaggi originali. Fissare il fusibile al cablaggio originale con una fascetta. Rimontare i coperchi originali.

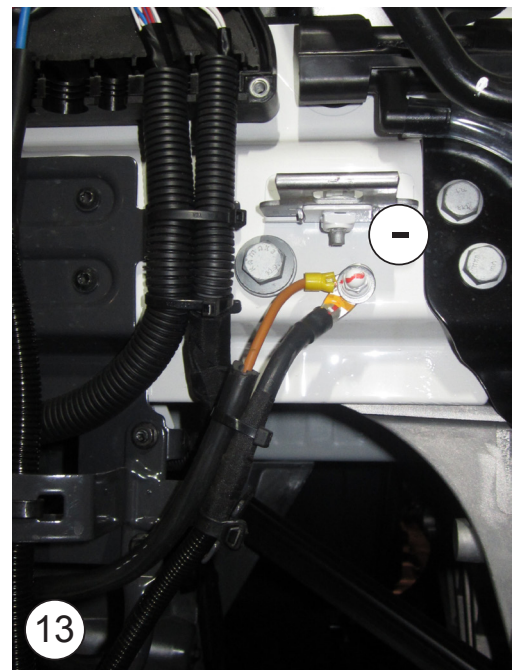
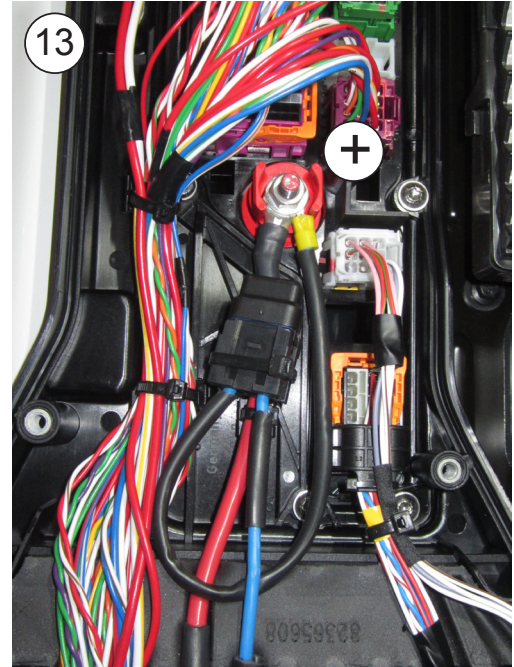
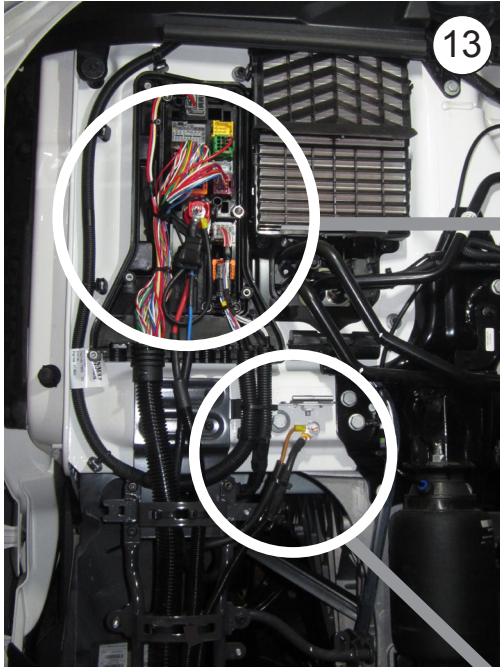

14

Ribaltare la cabina e fare il cablaggio dalla zona più adatta verso l'unità condensante, fissando con ghiera o flange.

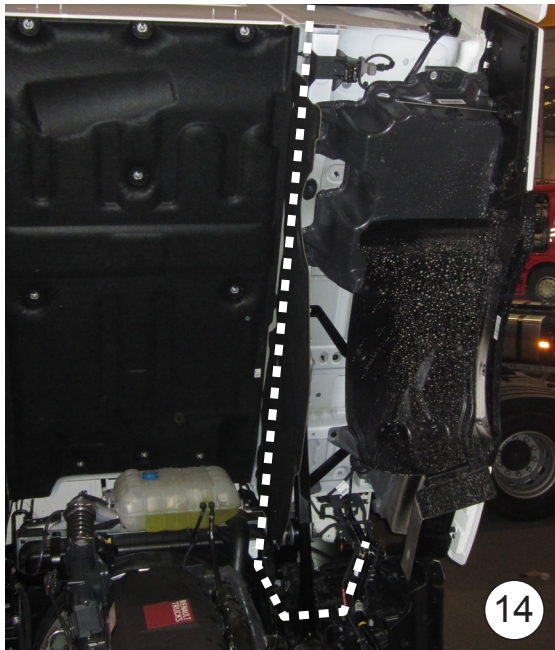
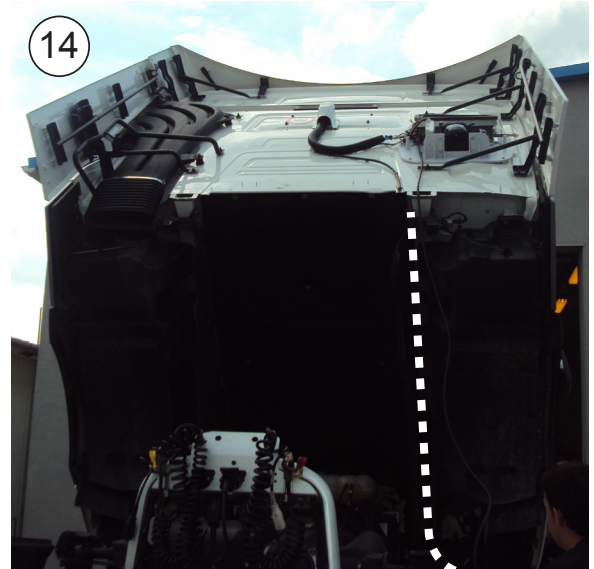
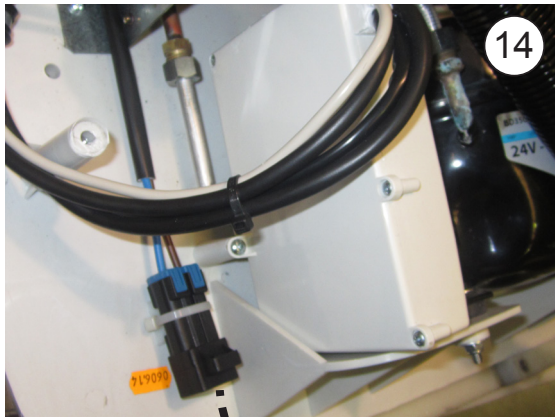

Smontare la protezione (*) e far passare il cablaggio sotto quest'ultima.

15

Collegare il cablaggio di alimentazione all'unità.

(-) = cavi M e N.
(+) = cavi R e Az.

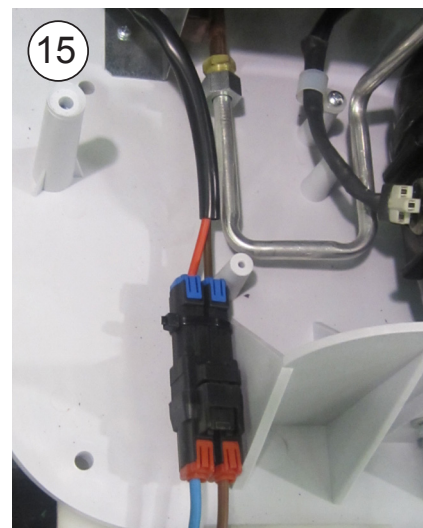

16

Montare il coperchio con le viti rimosse in precedenza.

**17**

Montare il coperchio protettivo dei raccordi con le viti autofilettanti 3,1x11 sul lato contrario a quello delle tubazioni.



CARICARE IL GAS:

18

Fare il vuoto nel circuito per almeno 30 minuti.

19

Immettere 300 g. di gas R134a e mettere l'impianto in funzione.

20

**VISTA GENERALE DELL'UNITÀ
CONDENSANTE E TUBAZIONE.**

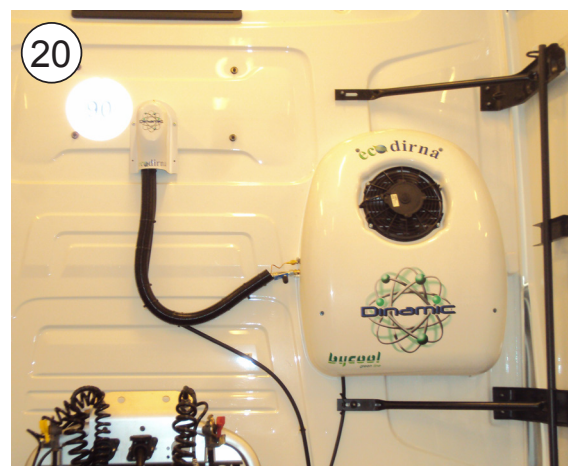

21

VISTA GENERALE DELL'UNITÀ
EVAPORANTE.



Cablaggio elettrico

AVVERTENZA IMPORTANTE!

Fare attenzione a non invertire le polarità nel collegamento dell'alimentazione dell'impianto. Infatti, in tal caso il quadro comandi non si accende e l'impianto non funziona.

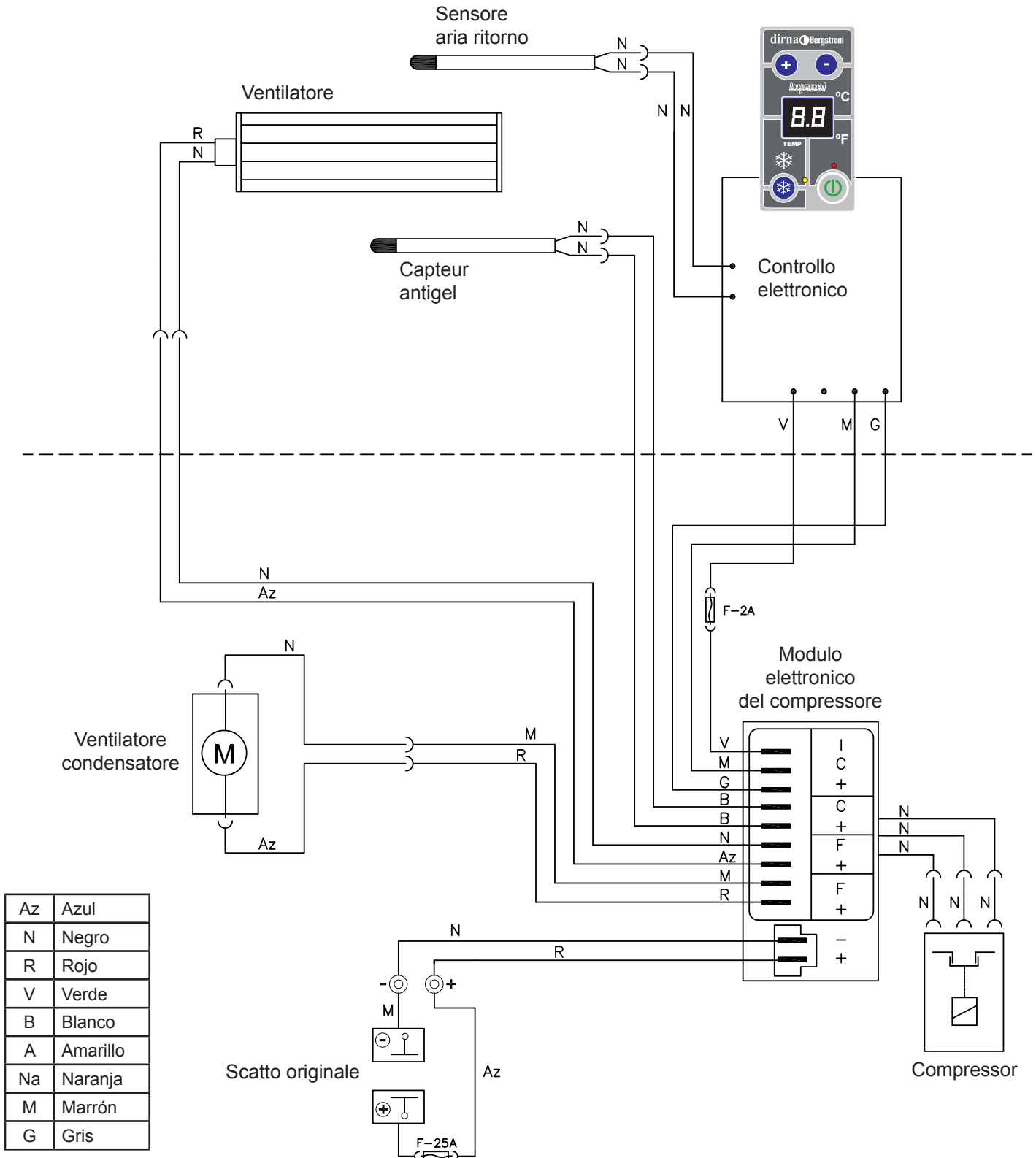







Ed:	04/07/2019
Md:	

Francisco Alonso, 6
28806 Alcalá de Henares, Madrid
SPAIN

Contact	Phone	Fax	E-Mail
Sales (Ventas Internacional)	+34 91 8770510	+34 91 8771158	sales@dirna.bergstrominc.com
Comercial Nacional	+34 91 8775841	+34 91 8836321	ventas@dirna.bergstrominc.com
Orders & Deliveries (Logística internacional)	+34 91 8775846	+34 91 8771158	export@dirna.bergstrominc.com
Orders & Deliveries (Logística nacional)	+34 91 8775840	+34 91 8836321	comercial@dirna.bergstrominc.com
Technical Assistance (Internacional)	+49 511 86679681	+49 511 86679710	technicalassistance@dirna.bergstrominc.com
Technical Assistance (Nacional)	+34 91 8775845	+34 91 883 6321	oblanco@dirna.bergstrominc.com

www.dirna.com

	ATENCIÓN:	Dirna Bergstrom se reserva el derecho de efectuar modificaciones en cualquier momento de los datos contenidos en esta publicación, por razones técnicas o comerciales.
	NOTE:	<i>For technical and commercial reasons, Dirna Bergstrom reserves the right to change the data contained in this brochure.</i>
	ATTENTION:	Dirna Bergstrom se réserve le droit d'effectuer à tout moment des modifications des données reprises sur cette publication, pour des raisons techniques ou commerciales.
	HIWEIS:	<i>Dirna Bergstrom behält sich vor, aus technischen oder kaufmännischen Gründen jederzeit Änderungen der Angaben dieser Veröffentlichung vorzunehmen.</i>
	ATTENZIONE:	Dirna Bergstrom si riserva il diritto di effettuare modifiche in qualsiasi momento ai dati contenuti in questa pubblicazione, per motivi tecnici o commerciali.