

CE

dirna  Bergstrom.

**bycool!**  
green line

**COMPACT 3.0**



**Instrucciones de Montaje**

*Mounting Instructions*

**Instructions de Montage**

*Montageanweisungen*

**Istruzioni di Montaggio**

**ES** Spanish

**EN** English

**FR** French

**GE** German

**IT** Italian

F-4218 rev.01



1001217242

### Recomendaciones Para el montaje

- Antes de iniciar el montaje leer las instrucciones y seguirlas durante el proceso de instalación.
- Usar las herramientas adecuadas para cada operación.

### Electricidad

- Desconectar la llave de contacto.
- Desconectar la batería antes de empezar el montaje.
- Asegurar el conexionado de los componentes eléctricos, verificando su correcto encaje.

### Atención

Si durante el montaje el equipo se inclina o se abate la cabina con el equipo montado, se deberá esperar un mínimo de 60 minutos, desde que el quipo quede horizontal, antes de ponerlo en marcha.

### Atención

Al instalar el equipo de aire acondicionado en el techo se debe proteger la parte superior de la cabina con un paño o manta protectora para evitar posibles arañazos. Al instalar **Compact** en el techo hay que tener en cuenta que, normalmente, las cabinas que vienen provistas de escotilla, tienen una estructura suficiente para soportar el peso del equipo. Sin embargo, cuando no ocurra así y sea necesario realizar corte en el techo o incluso si en el caso de llevar escotilla el material no es lo suficientemente resistente (caso de techo de fibra, plástico, etc...) es el instalador el que debe decidir, **bajo su responsabilidad**, sobre la necesidad de reforzar el techo para evitar posibles deformaciones, roturas, entradas de agua, etc... habilitando los medios para que esto no ocurra.

### Herramientas

Juego de Llaves Torx

Juego de Llaves Allen

Llave fija 10, 13, 14

Tijeras

Flexómetro

### Documentación incluida

Instrucciones de montaje	1001217242
Manual del usuario	1001218019
Diagnosis de averías	1001218025
Garantía	220AA10017

### Simbología



Frágil





Atención corte!



Riesgo eléctrico

### Advertencias

 El personal instalador debe poseer una formación suficiente en Aire Acondicionado de vehículos.

 **dirnaBergstrom, s.l.** queda exenta de responsabilidad si se producen averías que procedan de una inadecuada manipulación o instalación del equipo, o por modificaciones y sustituciones efectuadas sin nuestra expresa autorización por escrito.

 **Equipo precargado con gas refrigerante. (No manipular el circuito de gas refrigerante).**

 Véase **procedimiento de garantía** del producto incluido en **Diagnosis de Averías**.

 Véase **Manual de Usuario** del equipo para el correcto funcionamiento del mando a distancia y del panel de control.

 Al finalizar la instalación se debe entregar al usuario: **Manual del Usuario, Garantía y Diagnosis de averías.**

 Por norma general el techo de las cabinas van con los refuerzos suficientes para soportar el peso de equipo, si esto no fuera así hay que reforzar el techo de la cabina para que este no se deforme y aguante el peso del equipo.

 En vehículos que no lleven escotilla, pero llevan marcado en el techo el contorno para su colocación, hay que efectuar corte en el contorno premarcado, dejando la distancia necesaria para la colocación de la junta. **Esta operación se realiza siempre con la autorización del cliente.**

 En vehículos que no lleven escotilla y no lleven marcado en el techo el contorno para la instalación de ésta, hay que efectuar corte a las medidas indicadas en el lugar elegido para la colocación del equipo. **Ésta operación se realizará siempre con la autorización del cliente.**

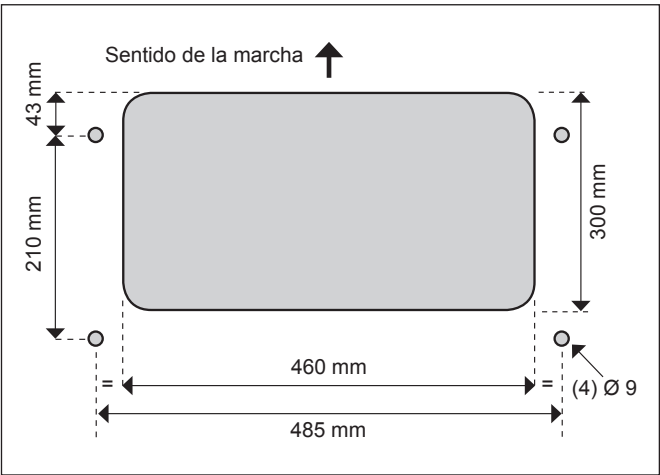

 Si se efectúan cortes o taladros en la chapa del vehículo, es recomendable aplicar pintura anticorrosiva en los mismos para evitar la corrosión.

 Antes de empezar con el montaje, montar rejilla entrada aire delantera.



**VEHÍCULOS CON ESCOTILLA ORIGINAL**

**1** Desmontar tapa escotilla, los elementos de fijación y entregar éstos al cliente.



**2** Quitar los residuos sobrantes adheridas al techo antes de pegar la junta EPDM.

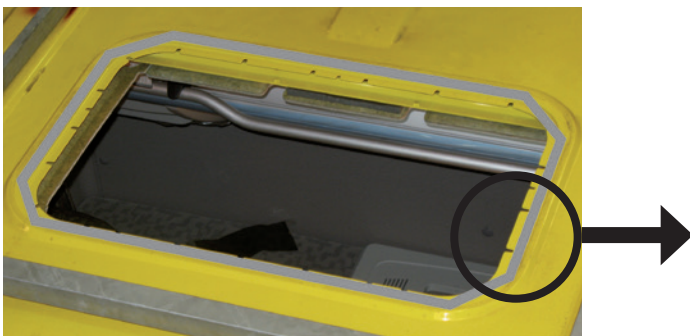



**3** En algunos modelos, el tapizado no deja hueco para introducir los soportes de fijación, por lo que se darán los cortes con las medidas indicadas en la foto.

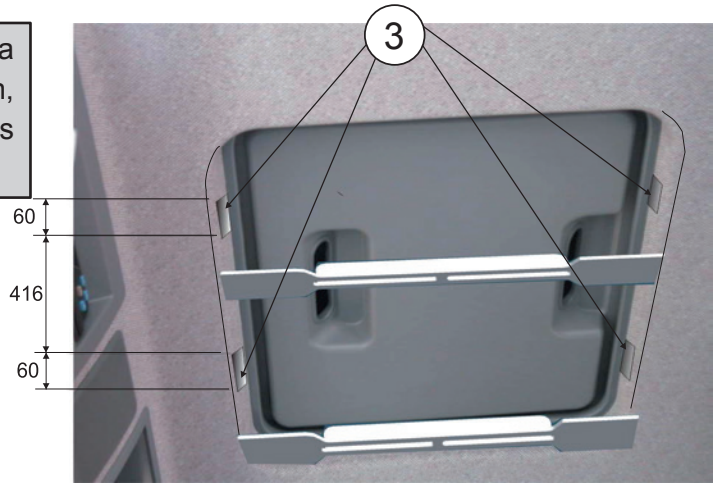

**4** En caso de que vehículo tenga spoiler con la barra central, cortar la barra mostrada por líneas de punto para instalar el equipo.  
  
Esta operación se realiza siempre con la autorización del cliente.

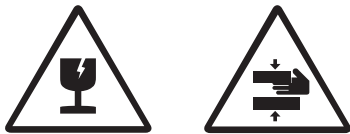

**TODOS LOS MODELOS**

**4a** Pegue la junta EPDM alrededor del hueco de escotilla o del corte efectuado (*mirar el detalle para cortar los bordes finales de unión de la junta*).  
  
**Atención:** En el corte realizado con taladros pegar la junta alrededor de los taladros.

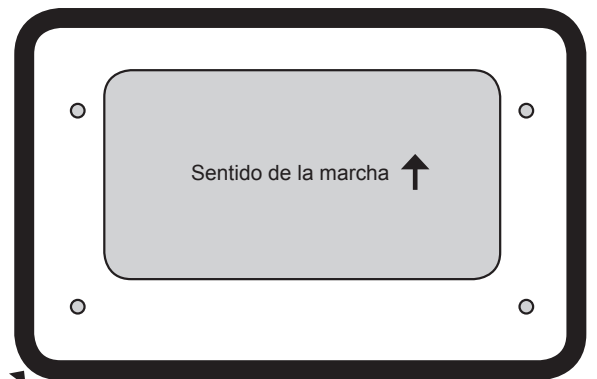
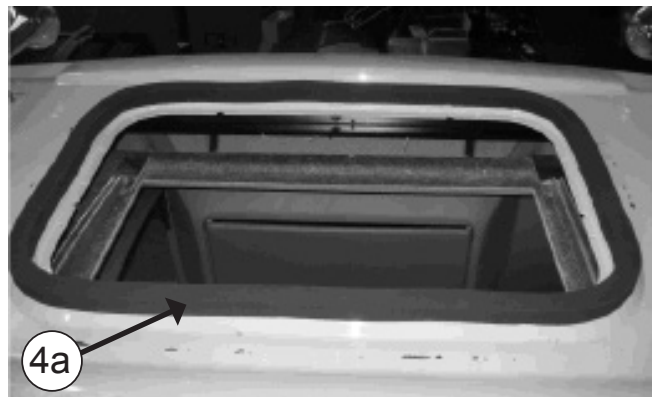

Junta EPDM



**COMO CORTAR LA JUNTA EPDM PARA EVITAR FILTRACIÓN DE AGUA EN LA CABINA**

- A- Pegar la junta, manteniendo 100 mm de papel protector por cada lado.
- B- Quitar los dos piezas de papel.
- C- Pegue presionado ambos finales.

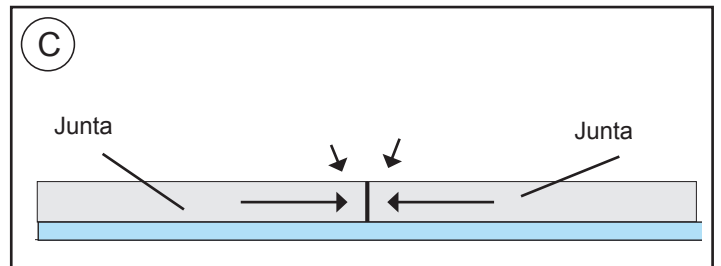
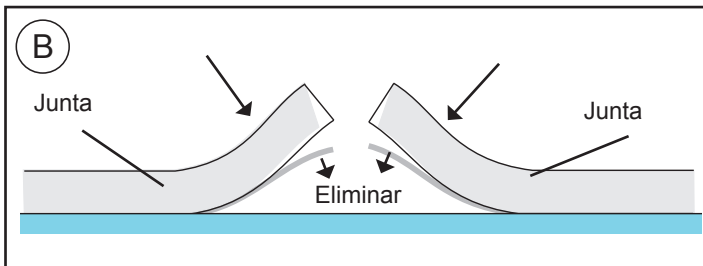
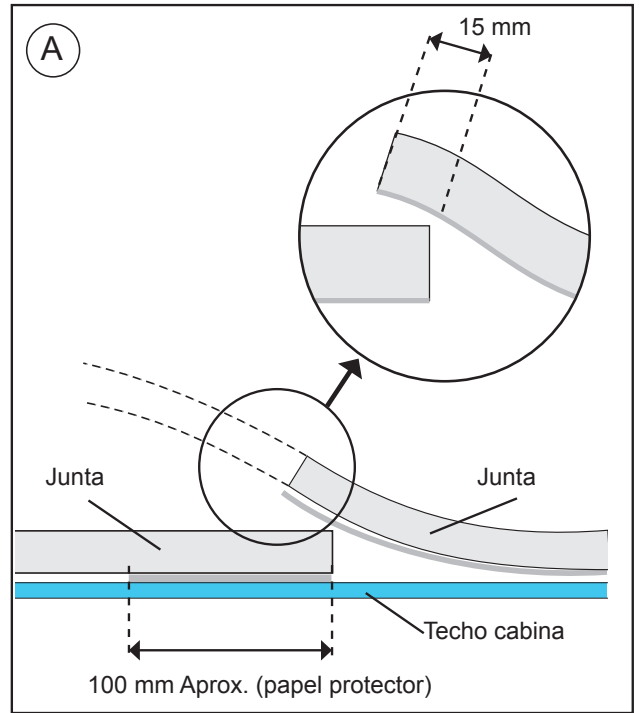

**VEHÍCULOS CON ESCOTILLA ORIGINAL O PREMARCADO EN EL TECHO PARA LA COLOCACIÓN DE LA ESCOTILLA**

5

**EXTERIOR CABINA:**

Posicionar el Compact en el hueco de la escotilla.

**Atención!** Al colocar el equipo encima del hueco escotilla, revisar que las salidas de desagüe no queden obstruidas por la junta EPDM.

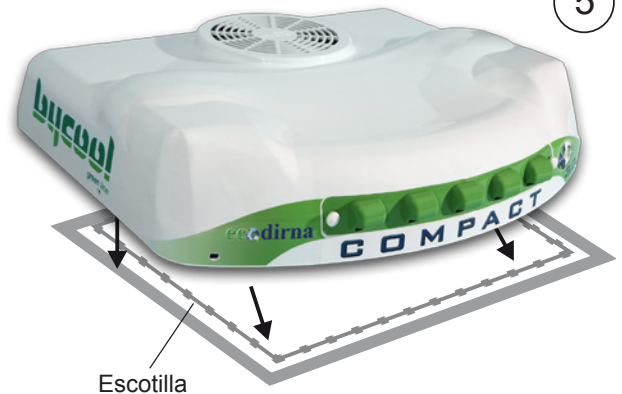

5

**6** Colocar (1) arandela Ø 7 de goma, (1) arandela plana Ø 8 ala ancha, (2) tuerca M8 y (1) arandela plana Ø 8 ala ancha, en cada uno de los espárragos anteriores; siguiendo dicho orden.

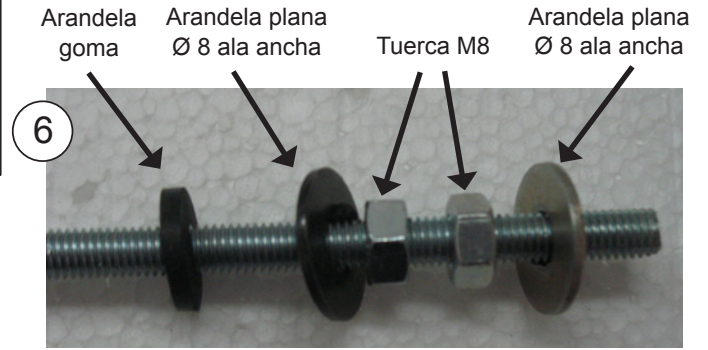

**7** **INTERIOR CABINA:**  
Roscar 5 mm aproximadamente (4) espárragos 8/125x100-70 o 120, la medida se elegirá tras presentar los soportes de sujeción y teniendo en cuenta que los espárragos deben sobresalir de los mismos por la parte inferior unos 20 mm.

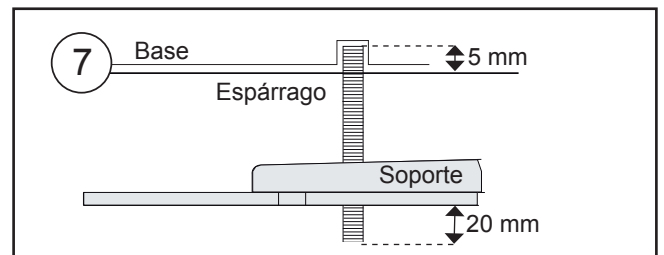

**8** Colocar (2) soportes sujeción, con (1) arandela y (1) tuerca autoblocante M8, **sin llegar a apretar.**

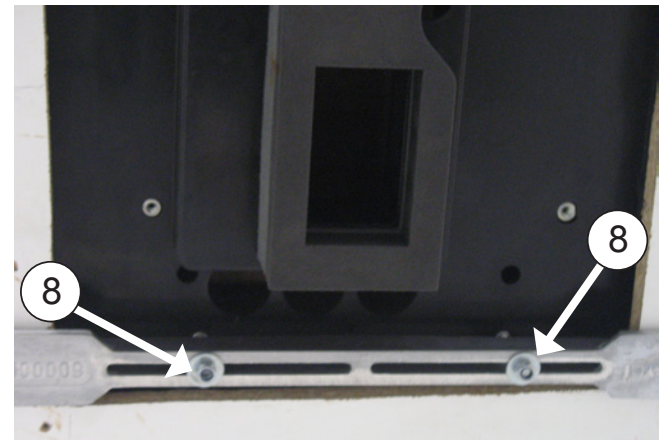
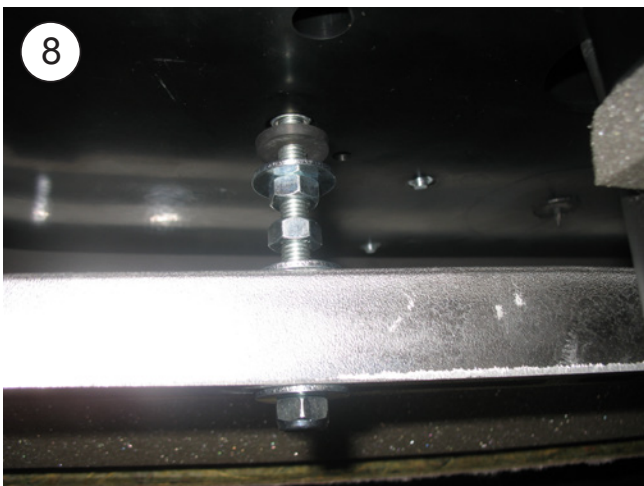

**VEHÍCULOS SIN ESCOTILLA ORIGINAL Y SIN PREMARCADO EN EL TECHO  
PARA LA COLOCACIÓN DE LA ESCOTILLA**

**5** Colocar (1) arandela Ø 7 de goma, (2) arandela plana Ø 8 ala ancha Y (2) tuercas M8 en (4) espárragos M8 más cortos en posición indicada.

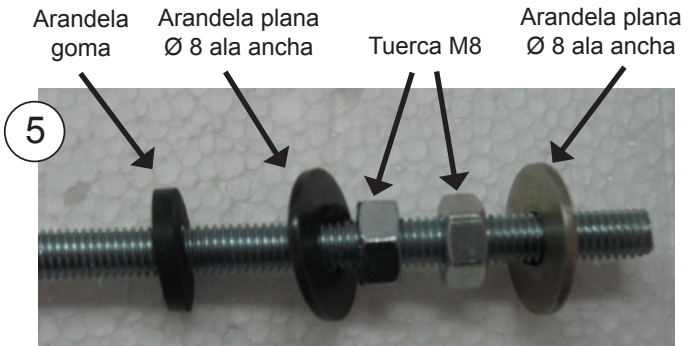

**6** Roscar 15 mm los espárragos en los insertos M8 de la base y apretar las tuercas contra la misma.  
**Atención:** La arandela de goma queda contra la base del equipo.



**7** Posicionar el Compact sobre el corte efectuado. Introduciendo los espárragos en los taladros de Ø 9 (\*) realizados a la vez que el corte.  
**Atención:** verificar que las salidas de desagüe quedan por fuera de la junta EPDM y no quedan obstruidos por la misma.

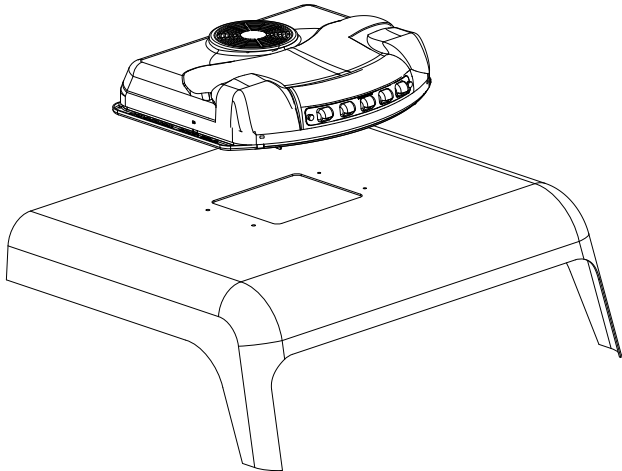



8

Colocar (1) arandela plana Ø 8 ala ancha y (1) tuerca M8/125 autoblocante y apretar hasta que la junta de EPDM se comprima entre 3 y 6 mm, después apretar la tuerca que queda por encima del techo de la cabina contra éste.

**¡Verificar la estanqueidad de la junta EPDM entre la base del equipo y el techo de la cabina!**

**¡Si fuera necesario reforzar techo de la cabina colocando soporte pegado a la parte inferior del techo de la cabina y fijándolo con las arandelas Ø 8 y tuercas M8/125 autoblocantes!**



Soporte de refuerzo

**TODOS LOS MODELOS**

9

Colocar canalizador gomaespuma quedando la parte más blanda en la base del equipo.

**Atención:** Dependiendo de la cabina, es posible que sea necesario usar los (2) canalizadores suministrados para que el panel de distribución de aire quede totalmente ajustado con ellos.



10

Roscar 10 mm (4) espárragos M6 x 55 o 80, donde se indica, según distancia (D) del esquema del punto 16.

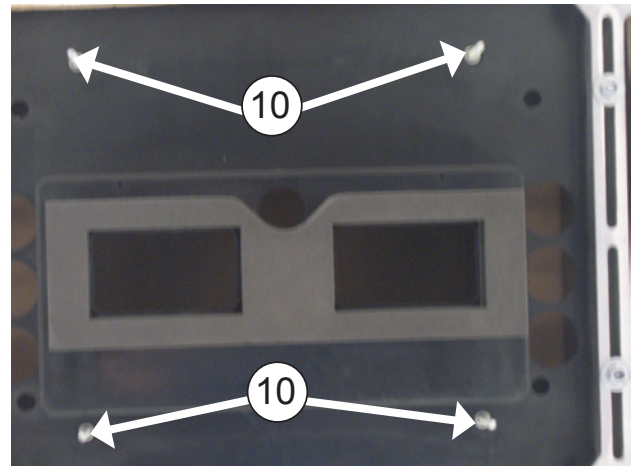
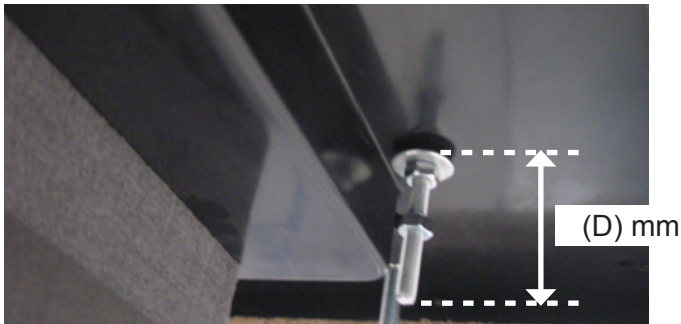

11

Colocar (1) arandela Ø6 de goma, (1) arandela plana Ø6 ala ancha y (1) tuerca M6, sobre cada uno de los espárragos de M6. **Apretar tuerca**, a continuación apretar tuerca hasta que la arandela de goma quede un poco oprimida.

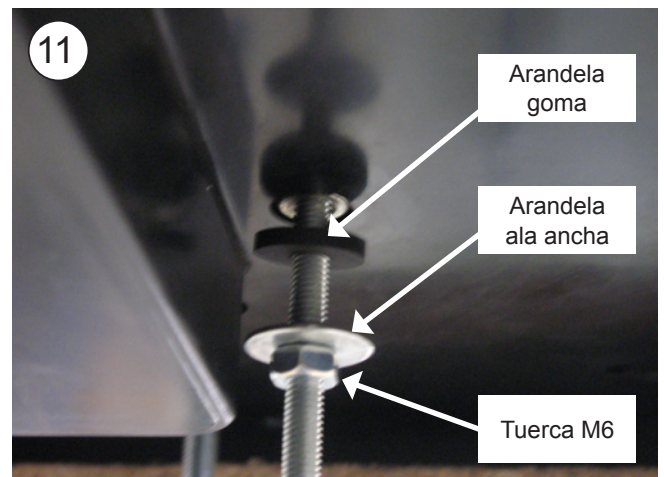

12

Colocar (1) tuerca M6 sin apretar en cada espárrago.

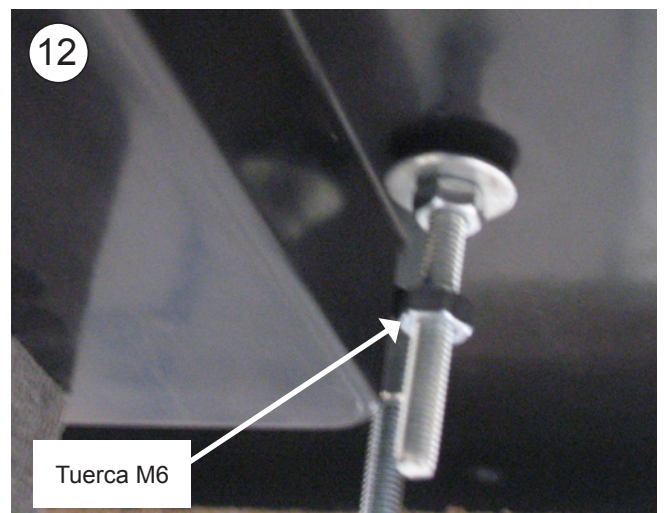



13

Entre la base y el panel interior de distribución de aire, conectar (2) cajas de dos vías de sensor antihielo (cables blancos) y sensor aire de retorno (cables negros), caja de 4 vías del soplador, (2) cables de comunicación y caja de 8 vías de cableado a conexión con control electrónico.

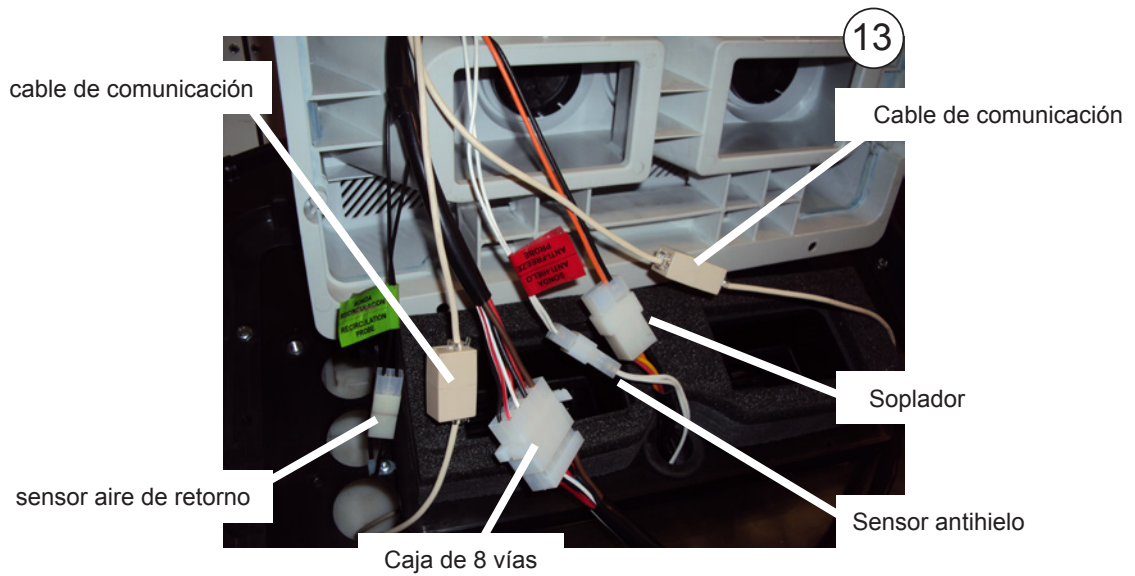

14

Colocar el panel interior de distribución de aire en los espárragos anteriores con (1) arandela M6 ala ancha y (1) tuerca M6 en cada espárrago. Apretar tuercas hasta que el canalizador del panel interior de distribución de aire haga tope en goma espuma superior del equipo.

**Importante:** El canalizador del panel interior de distribución de aire debe hacer tope contra la goma espuma superior del equipo para evitar fugas de aire.

Tener la precaución de no pillar los cableados entre el canalizador y la gomaespuma colocada en la base del equipo.

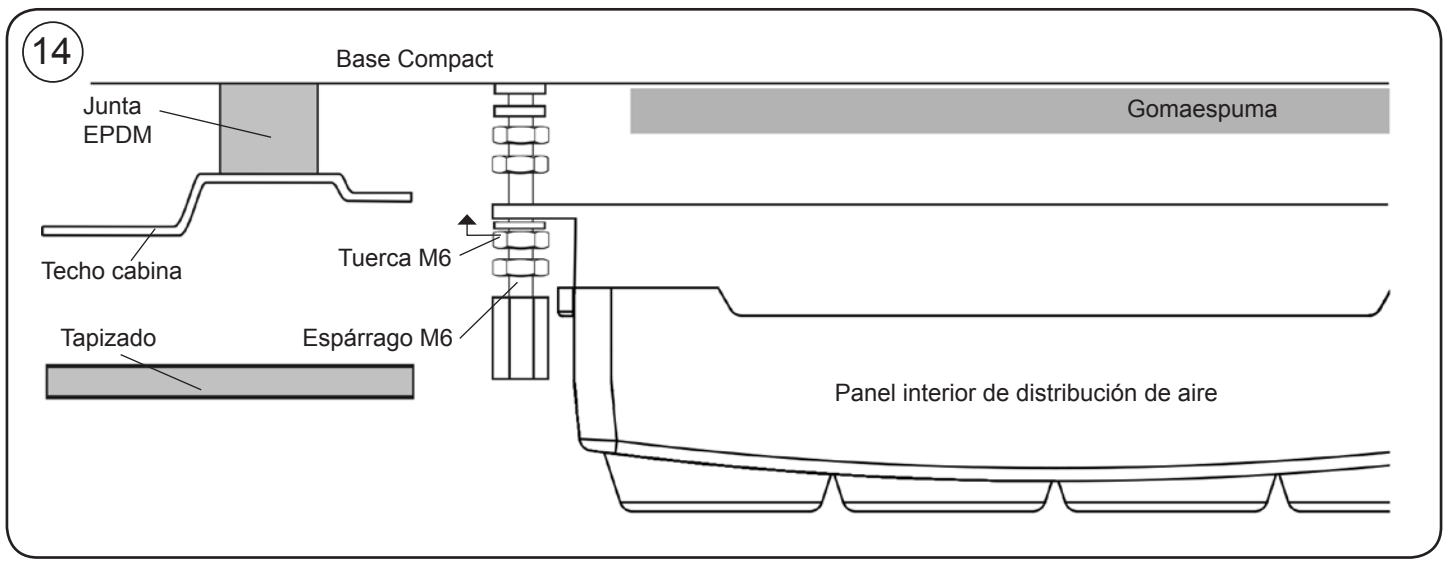

15

Apertar tuerca del punto 12 hasta hacer tope con la parte superior del panel interior de distribución de aire.

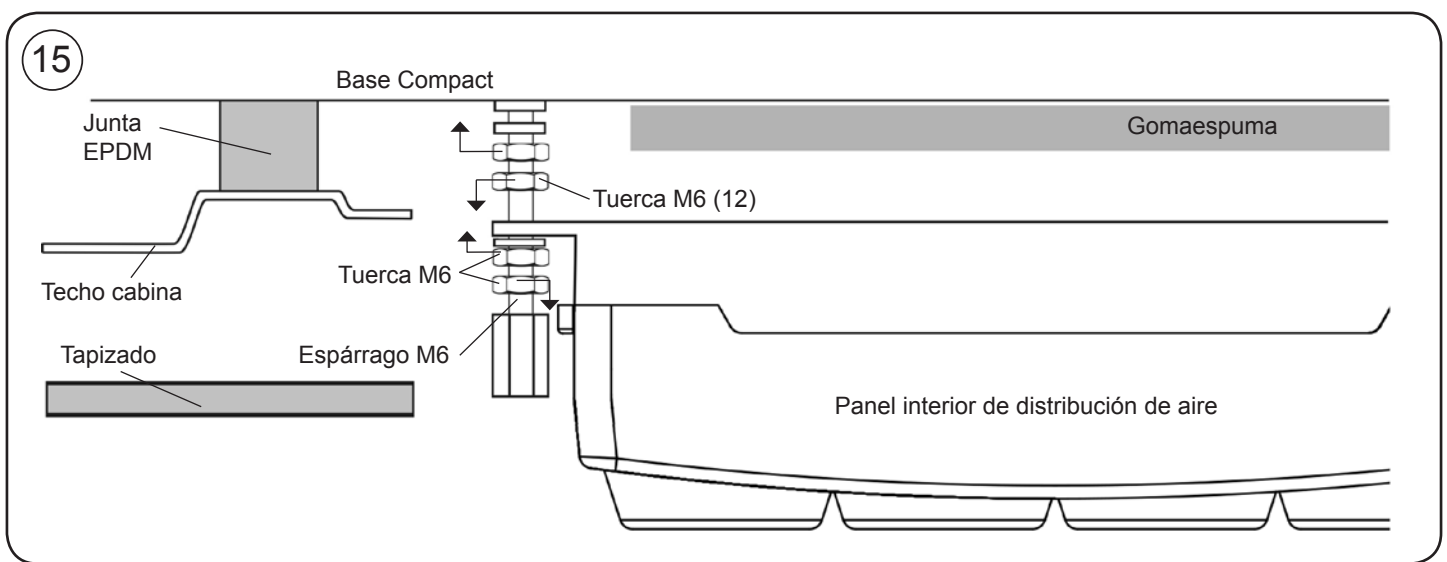

**VEHÍCULOS CON ESCOTILLA ORIGINAL O PREMARCADO EN EL TECHO PARA LA COLOCACIÓN DE LA ESCOTILLA**

**15a**

Presentar consola y centrar el equipo en el sitio más conveniente del techo de la cabina. Una vez centrado quitar consola.

**15b**

Fijar los soportes de sujeción apretando las tuercas hasta el apriete de la junta de EPDM exterior del equipo entre 3 y 6 mm.

**Importante:** Para evitar posibles filtraciones de agua al interior de la cabina se debe asegurar el apriete de la junta EPDM con la base del Compact tal y como se indica en el **esquema**.



Comprobar la compresión de la junta EPDM usando un flexómetro en las cuatro esquinas.

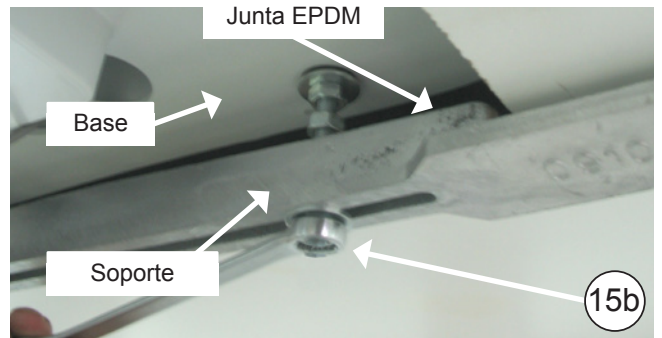
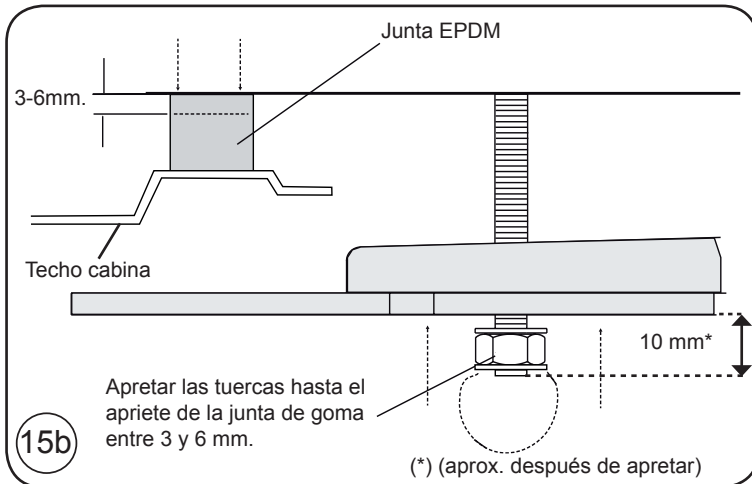

**15c**

Apretar (4) tuercas M8 al soporte y (4) a la base del Compact.

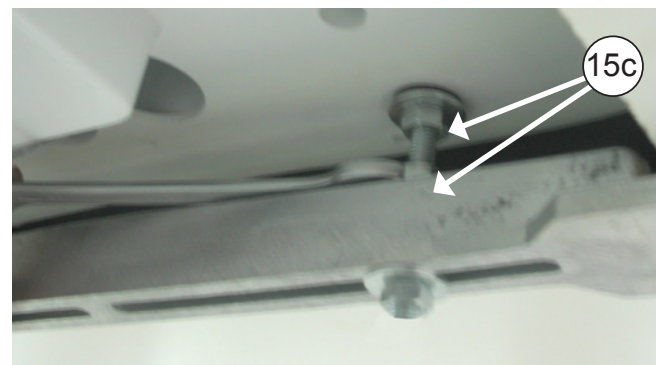

TODOS LOS MODELOS

16

Colocar tuerca M6 (A) tras la tuerca de fijación del panel interior de distribución de aire en cada espárrago. Colocar hexágonos M6 roscándolo hasta que quede 1 mm por encima del tapizado. Desenroscar tuercas M6 (A) de este punto hasta que haga tope con los hexágonos y apretar contra estos.

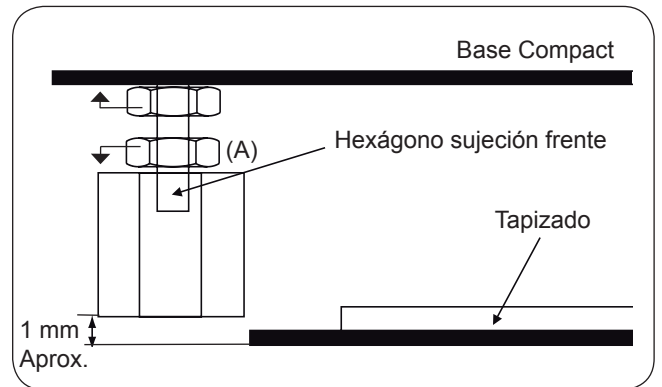

16

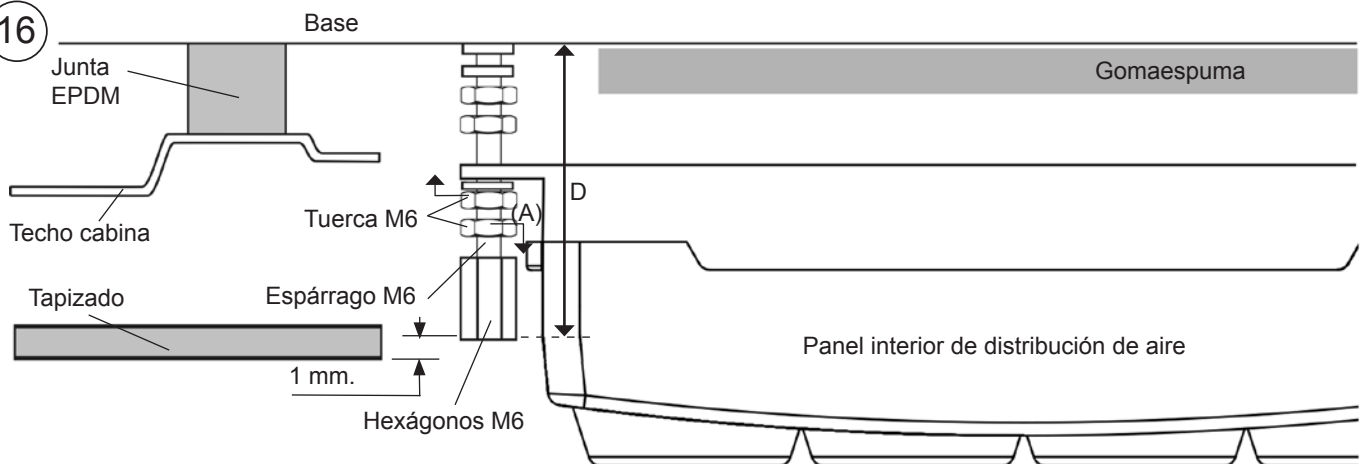

17

Colocar la consola con (4) tornillos M6/100x15 allen.

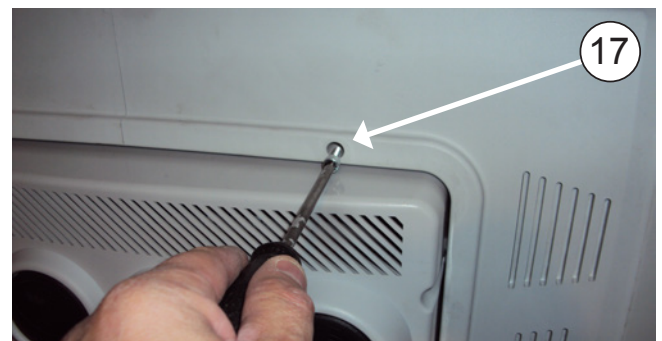

18

Cubrir los (4) tornillos M6/100x15 allen con los embellecedores redondos de M6 de plástico.



**VEHÍCULOS SIN ESCOTILLA ORIGINAL Y SIN PREMARCADO EN EL TECHO PARA LA COLOCACIÓN DE LA ESCOTILLA**

**Vista explosionada hasta la fijación de los soportes**

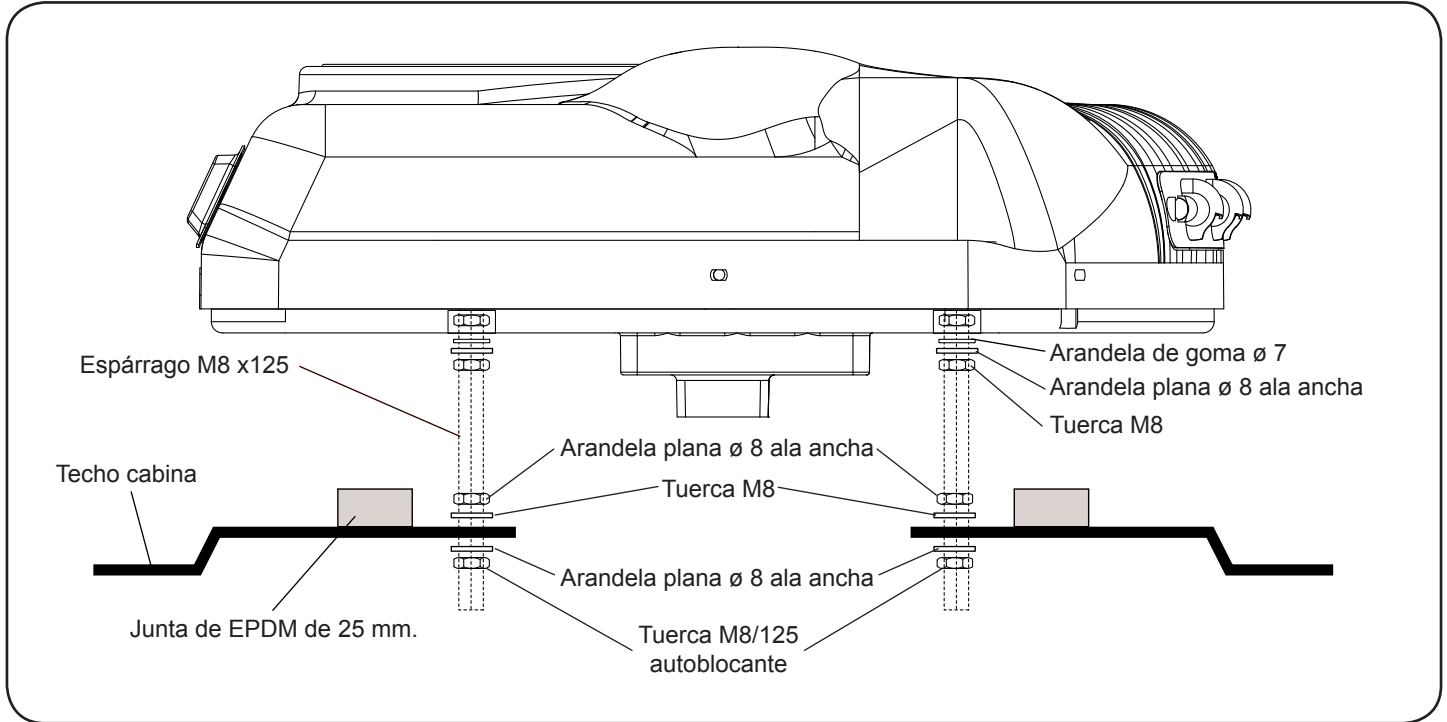

**Vista explosionada hasta la fijación de las consolas**

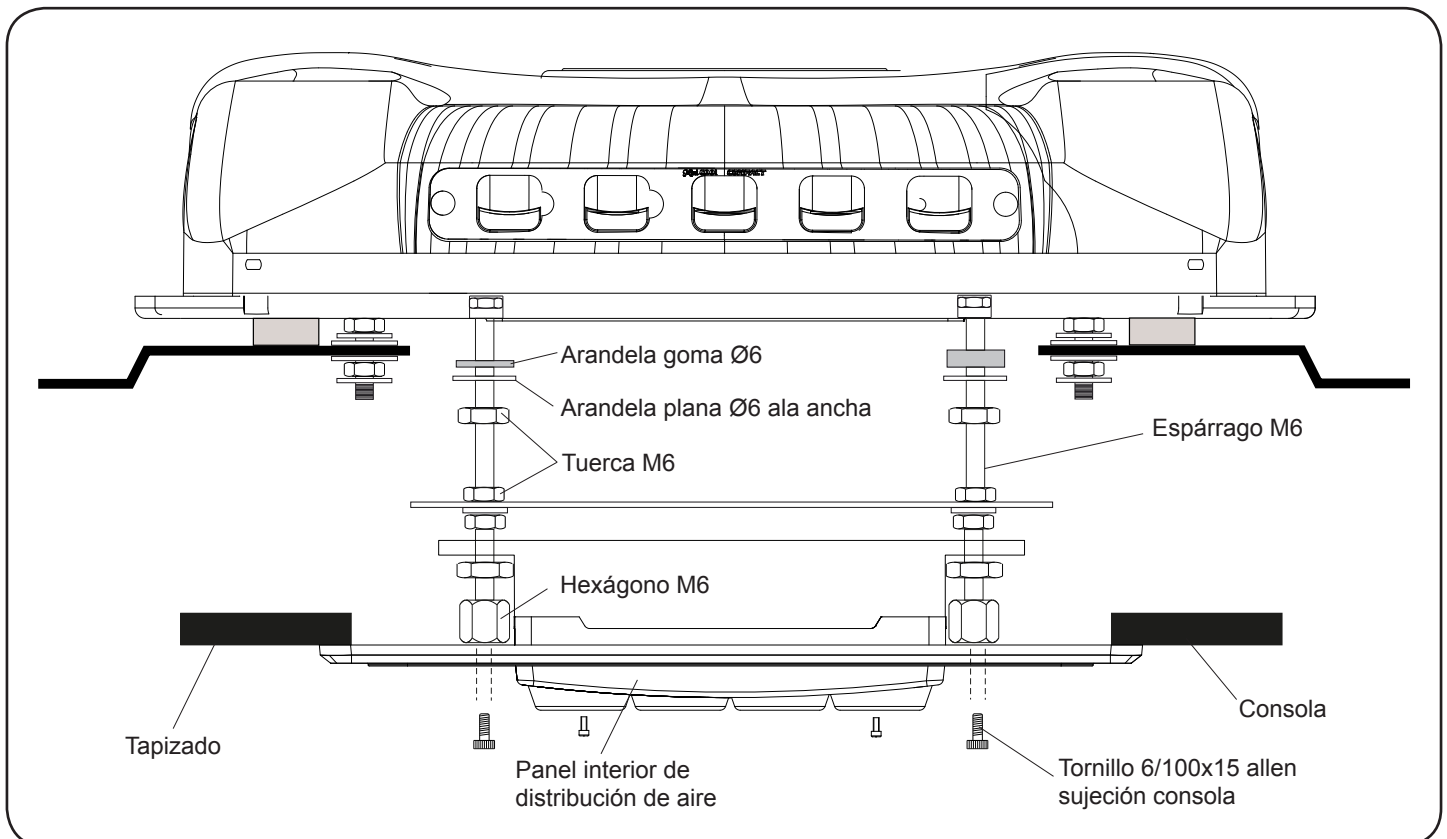

VEHÍCULOS CON ESCOTILLA ORIGINAL O PREMARCADO EN EL TECHO PARA LA COLOCACIÓN DE LA ESCOTILLA

Vista explosionada hasta la fijación de los soportes

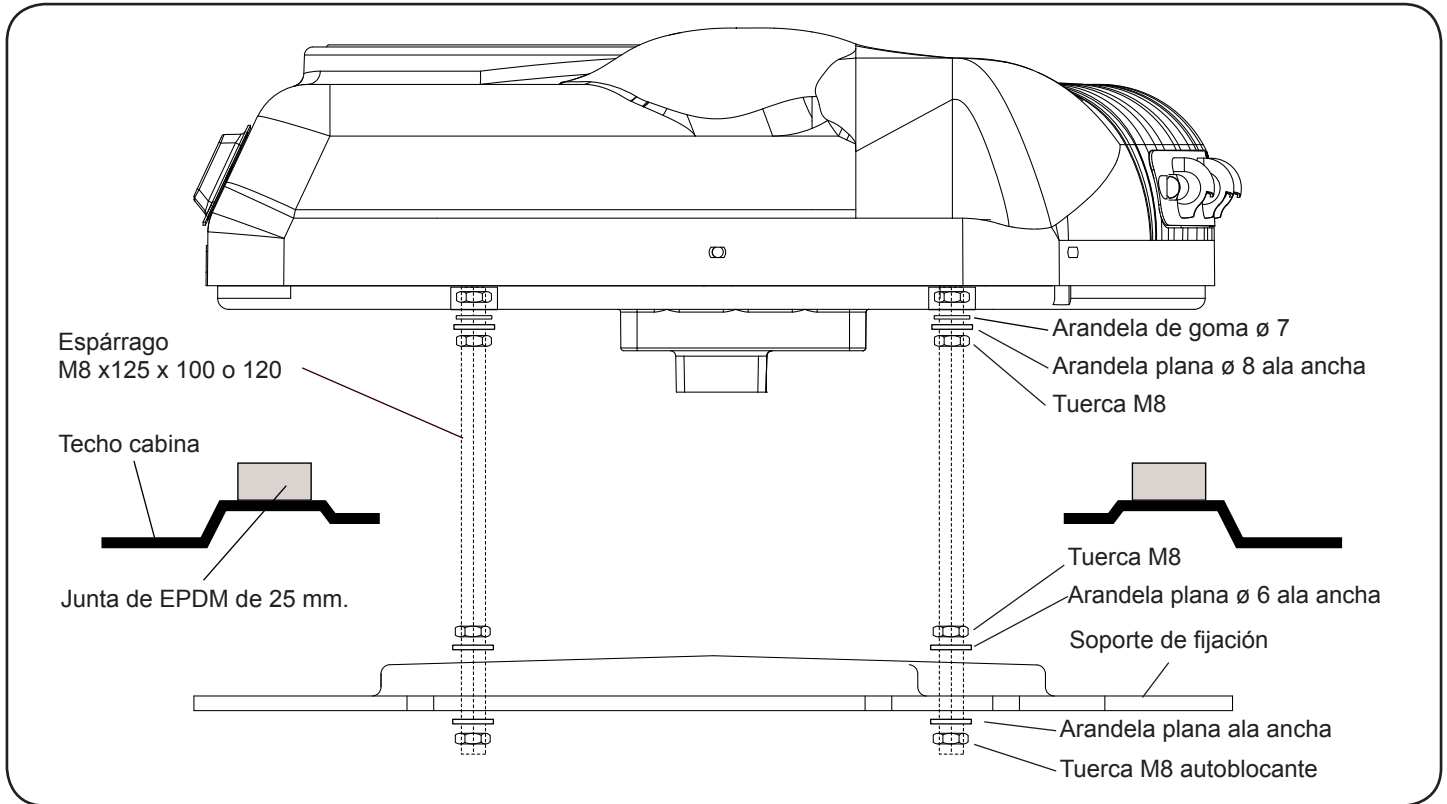

Vista explosionada hasta la fijación de las consolas

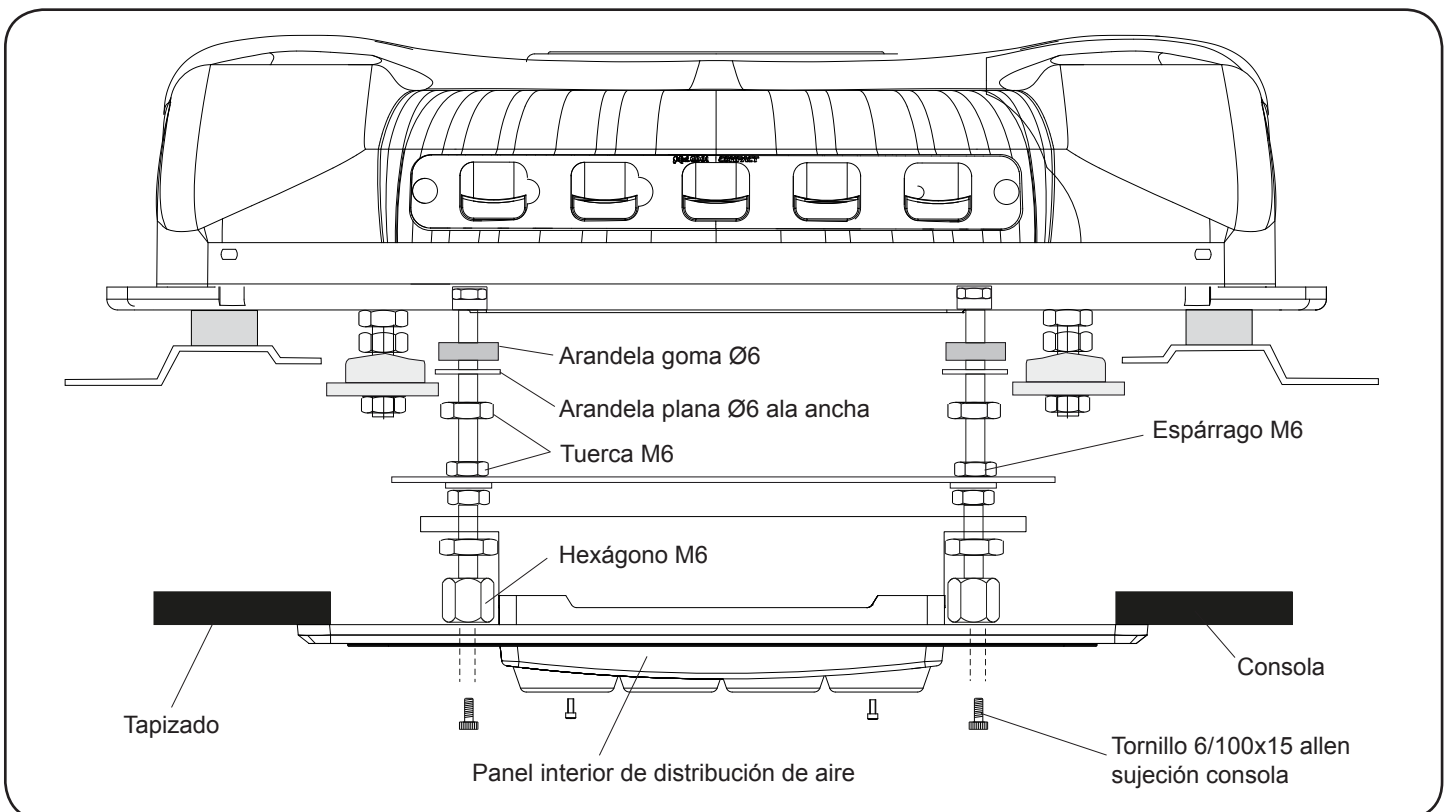



## Instrucciones detalladas sobre la instalación del cableado de alimentación

**1** Conectar el cable de alimentación superior en la parte trasera del equipo y llevarlo por la parte posterior de la cabina pegando los soportes de plástico y fijándolo con bridas.

**2** Conectar cable de alimentación inferior en batería, llevándolo por el paso de cableados original, sujeto con bridas, hacia la parte posterior de la cabina, para conectar con el cable de alimentación superior.

 **¡Al conectar los cableados, dejar la distancia adecuada ,para evitar su rotura por los movimientos de la cabina!**

**Importante:** Debido al complejo sistema de regulación electrónica del equipo, la toma de corriente debe realizarse directamente a la batería del vehículo.

**Importante:** Para la puesta en marcha consultar el **Manual del Usuario**.

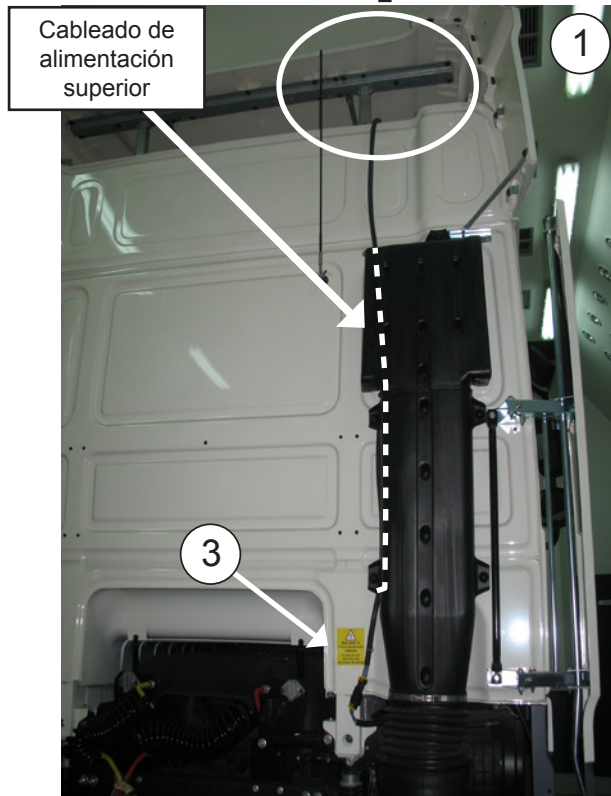
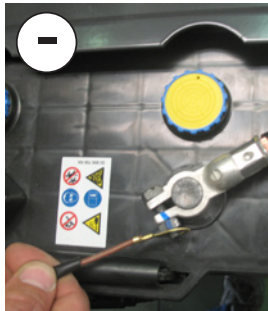
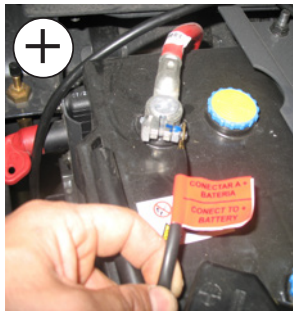
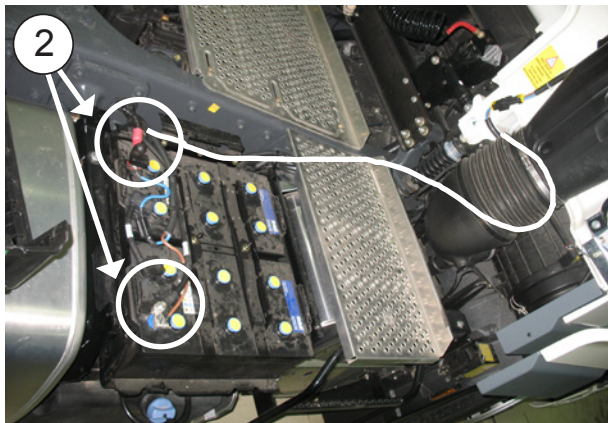

**3** Colocar adhesivos de peligro en unión de cableado y en dispositivo de elevación de cabina.



Esquema eléctrico

¡AVISO IMPORTANTE!

Precaución de no invertir las polaridades al conectar la alimentación en el equipo. Si esto sucediera la placa no se enciende y el equipo no funciona y se producirán daños irreparables en los módulos de los compresores.

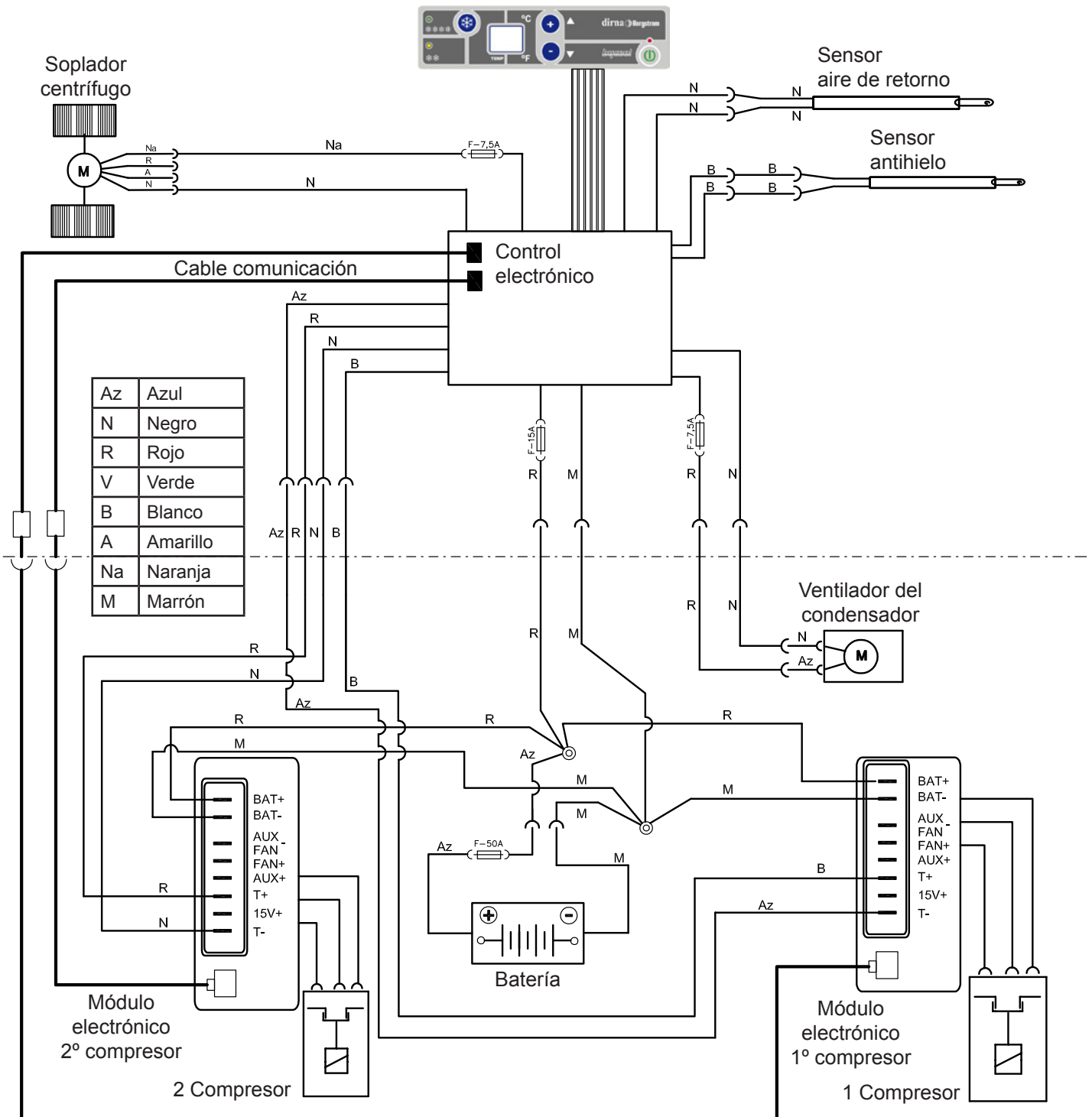

A series of horizontal dotted lines for writing, spanning the width of the page.

### Assembly Recommendations

- Before starting assembly, please read instructions and follow them during installation process.
- Use the adequate tools for each operation.

### Electricity

- Disconnect ignition key.
- Disconnect battery before starting assembly.
- Make sure electric components are securely connected, checking their correct fitting.

### Warning

**If the unit slants during assembly, wait for at least 60 minutes with the unit in horizontal position before starting it up.**

### Warning

When installing air conditioning equipment on roof, the upper cabin part must be protected with a cloth or a protective blanket to avoid possible scratches. When installing **Compact** on roof, take into account that, normally, cabins equipped with a hatch have a strong enough structure to hold equipment weight. However, if it is not the case and it is necessary to carry out a cut in the roof or, although it has a hatch, the material is not resistant enough (*if roof is made of fibre, plastic, etc...*), it is the installer who will have to decide, under his responsibility, if it is necessary to reinforce the roof to avoid possible deformations, breaks, water entries, etc., habilitating the means required to stop it from occurring.



### Tools

- Torx wrenches set
- Allen wrenches set
- Open-jawed spanner 10, 13, 14
- Scissors
- Flexo-meter







### Documentation included

Mounting instructions	1001217242
User's guide	1001218019
Troubleshooting	1001218025
Warranty	220AA10017

### Symbology

-  Fragile
-  Beware of cuts!
-  Electrical hazard

### Warnings

-  The installing personnel must have a sufficient training in vehicles air conditioning.
-  **dirna Bergstrom, s.l.** shall not be responsible for breakdowns or damages coming from an inadequate handling or installation of the equipment or from modifications and substitutions carried out without our express and written authorisation.
-  **Equipment pre-charged with refrigerating gas. (Do not handle refrigerating gas circuit).**
-  Please see product **warranty procedure** included in **Troubleshooting**.
-  Please see equipment **User's Guide** for its correct functioning of the remote control and control panel.
-  Once installation is finished, the following documents must be handed over to the user: **User's Guide, Warranty and Troubleshooting.**

 In general, the roof of the cabins are strong enough to support the weight of the unit; if this is not the case, reinforce the cabin roof to ensure it withstands the weight of the unit and prevent any deformation.

 In vehicles which do not have a hatch but have the contour for installation marked in the roof, make the cut in the pre-marked contour, leaving the distance necessary to position the seal. **This operation is always carried out with the authorisation of the customer.**

 In vehicles which do not have a hatch and do not have the contour for installation marked in the roof, it is necessary to cut at the measurements indicated in the place chosen to position the equipment. **This operation is always carried out with the authorisation of the customer.**

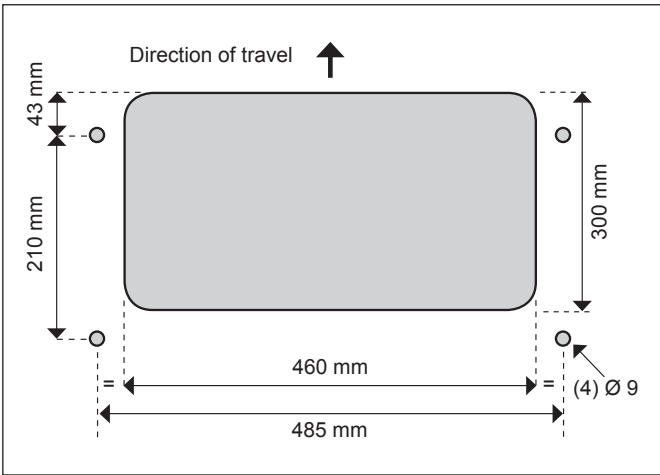

 If cuts or boreholes are made in the vehicle's bodywork, we recommend applying anti-rust paint to prevent any corrosion.

 Mount the front air input grille before starting assembly.



VEHICLES WITH ORIGINAL HATCH

1 Take down the hatch cover and the fastening elements, and hand them over to the customer.



2 Remove any waste stuck to the roof before attaching the EPDM seal.

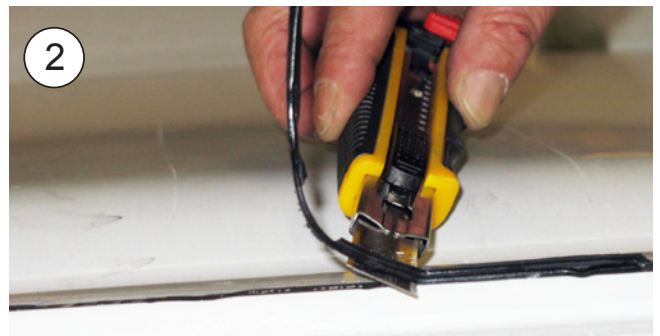
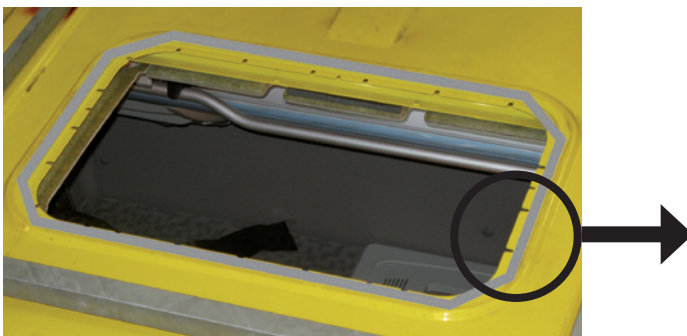



**3** In some models, the attachment supports cannot be inserted through a gap in the upholstery, meaning it is necessary to cut at the measurements shown in the photo.

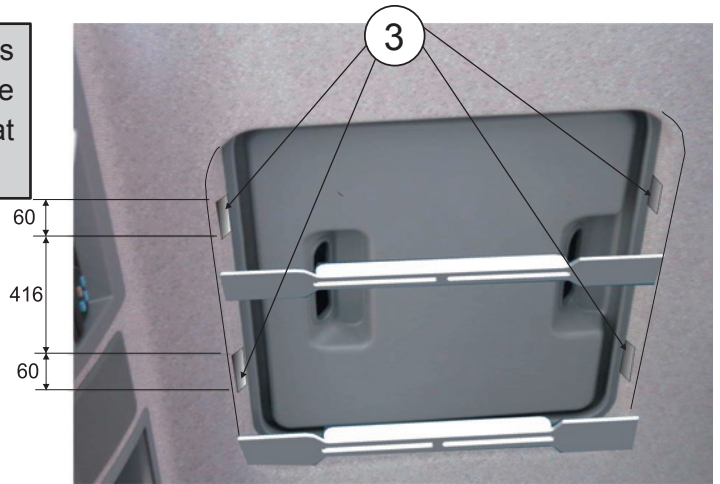

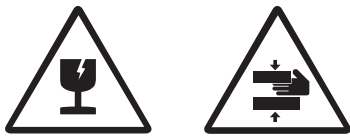
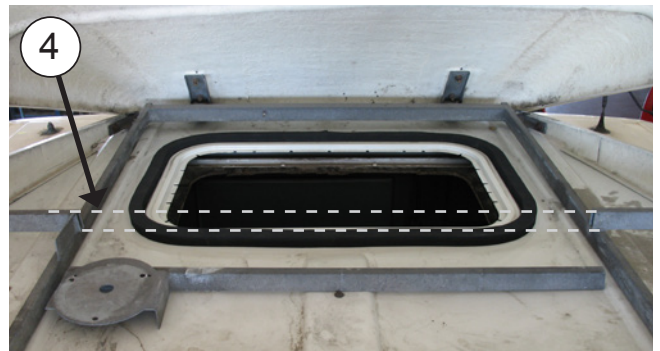

**4** If the vehicle is fitted with a spoiler with the central bar, cut the bar shown along the dotted line to install the unit.  
  
This operation is always carried out with the authorisation of the customer.

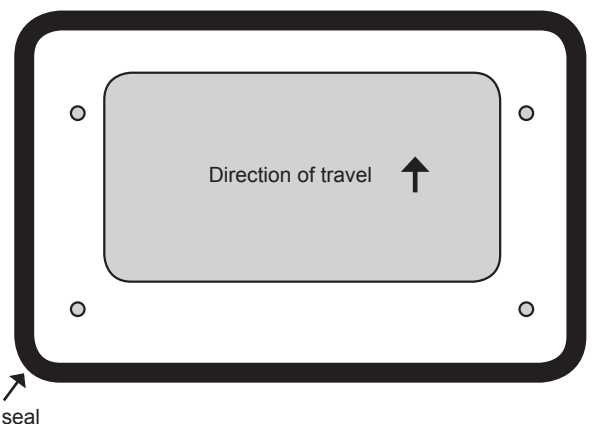
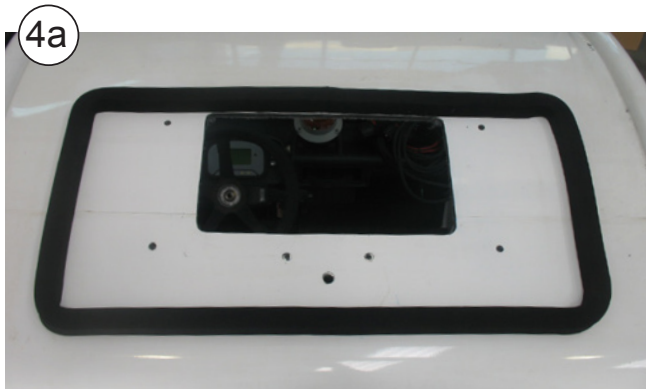
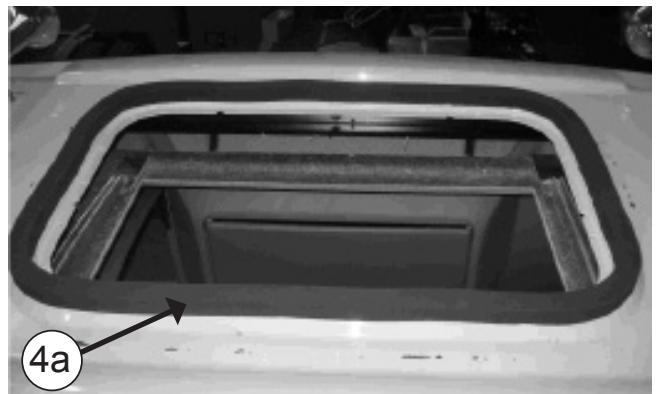

**ALL MODELS**

**4a** Attach the EPDM seal around the hatch gap or the cut made (see the details to cut the ends of the seal joint).  
  
**Caution:** Attach the seal around the boreholes in the cut made.



 **HOW TO CUT EPDM GASKET TO AVOID WATER FILTRATION INTO THE CABIN**

**A-** Glue gasket, keeping 100 mm of protection paper at each side.

**B-** Remove the two pieces of paper.

**C-** Glue by pressing both ends.

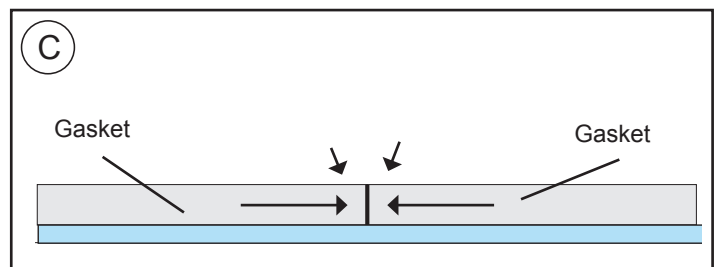
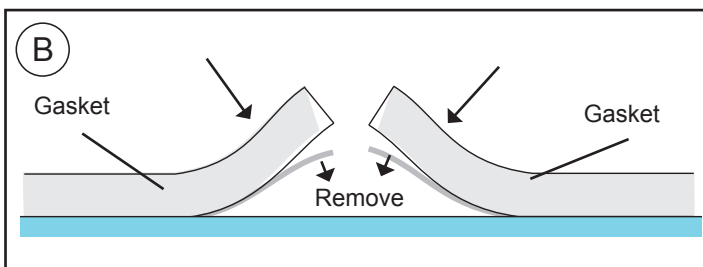
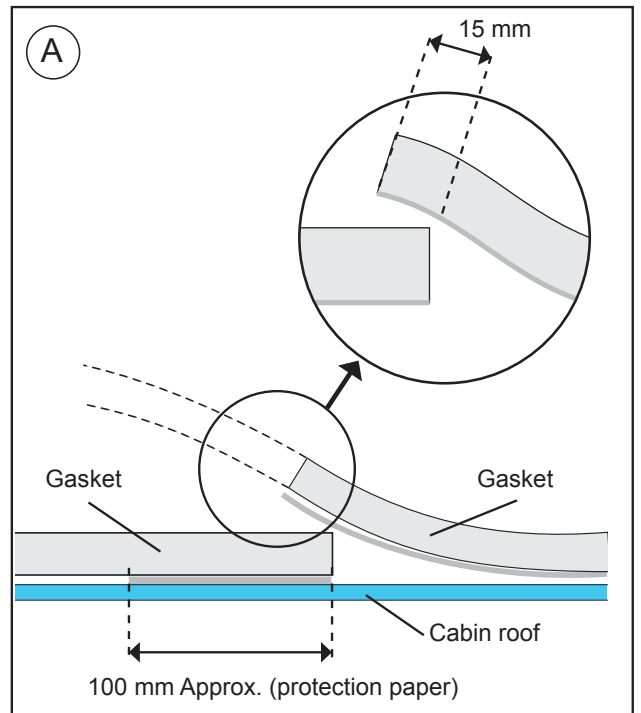

**VEHICLES WITH ORIGINAL HATCH OR PRE-MARKING IN THE ROOF FOR INSTALLATION OF THE HATCH**

**5** **CABIN EXTERIOR:**

Position the Compact in the hatch gap.

**Caution!** When positioning the unit above the hatch gap, check that the wastewater run-offs are not blocked by the EPDM seal.

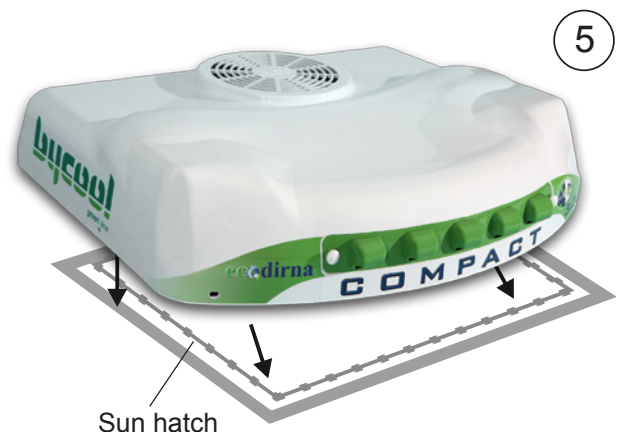

**6** Position (1) Ø7 rubber washer, (1) Ø8 flat wide-rimmed washer, (2) M8 nuts and (1) Ø8 flat wide-rimmed washer on each one of these studs, in the same order.

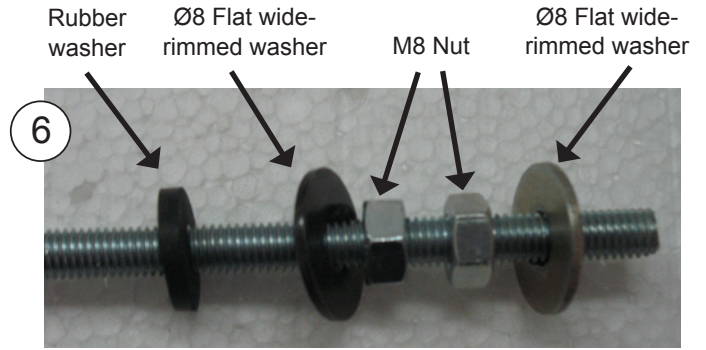

**7** **CABIN INTERIOR:**  
Screw (4) 8/125x100-70 or 120 studs around 5 mm; the size will be chosen after positioning the fastening supports and bearing in mind that the studs must protrude from the bottom by about 20 mm.

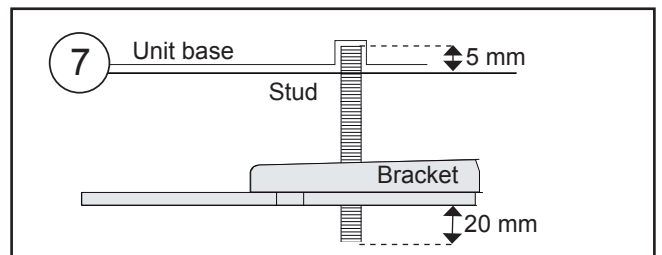

**8** Position (2) attachment supports, with (1) washer and (1) M8 self-locking nut, **without tightening.**

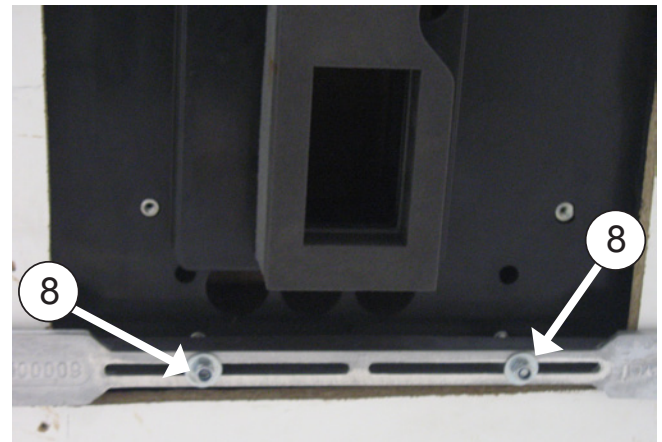
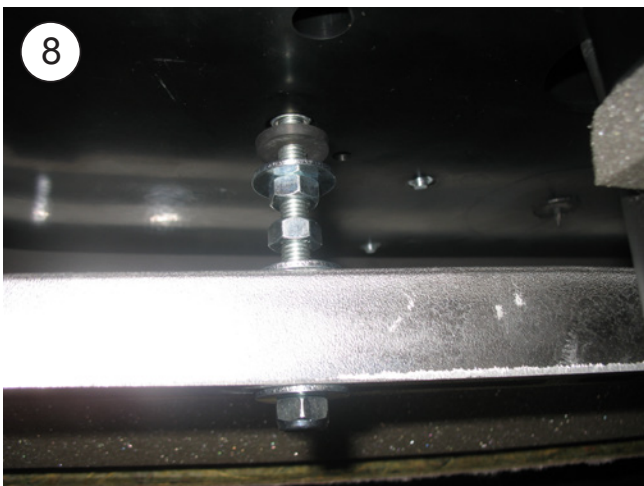

**VEHICLES WITH ORIGINAL HATCH AND WITHOUT PRE-MARKING IN THE ROOF FOR INSTALLATION OF THE HATCH**

**5** Position (1) Ø7 rubber washer, (2) Ø8 flat wide-rimmed washers and (2) M8 nuts and (4) Ø8 shorter studs in the indicated position.

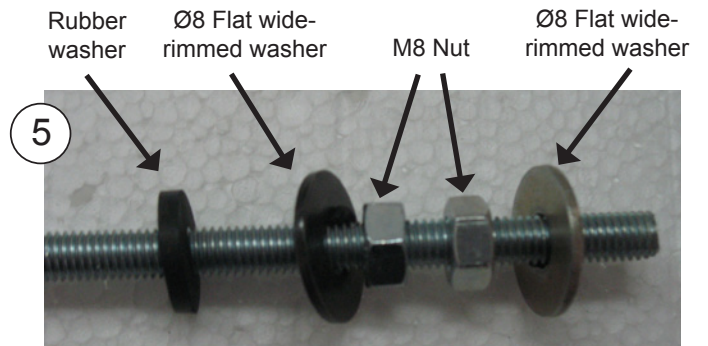

**6** Screw the studs 15 mm in the M8 inserts of the base and tighten the nuts against it.

**Caution:** The rubber washer remains in place against the base of the unit.

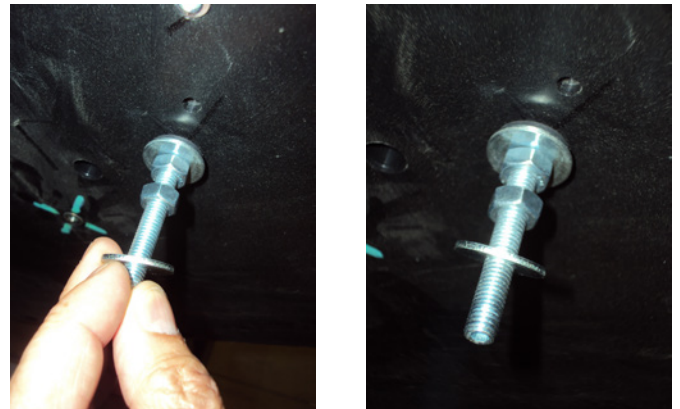

**7** Position the Compact on the cut made. Introduce the studs in the Ø9 (\*) boreholes made along with the cut.

**Caution:** Check that the water run-offs are outside the EPDM seal and are not obstructed by it.

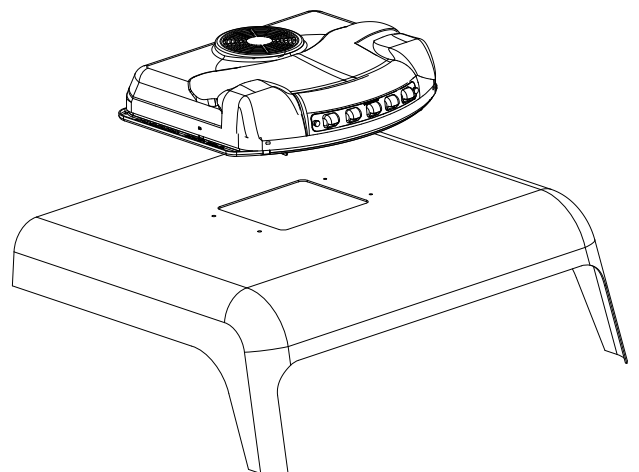



8

Position (1) Ø8 flat wide-rimmed washer and (1) self-locking M8/125 nut and tighten until the EPDM seal is compressed between 3 and 6 mm, then tighten the nut above the roof of the cabin against it.

**Check the sealtight integrity of the EPDM seal between the base of the unit and the cabin roof.**

**If necessary, reinforce the cabin roof by positioning a support piece attached to the bottom of the roof and securing it with the Ø8 washers and M8/125 self-locking nuts.**



Reinforcement piece

ALL MODELS

9

Position foam rubber, ensuring the softest part is placed on the base of the unit.

**Caution:** Depending on the cabin, it may be necessary to use the (2) supplied ducts in order for the air distribution panel to be completely adjusted.



10

Screw 10 mm (4) M6 x 55 or 80 studs as indicated, in accordance with the distance (D) in the diagram of point 16.

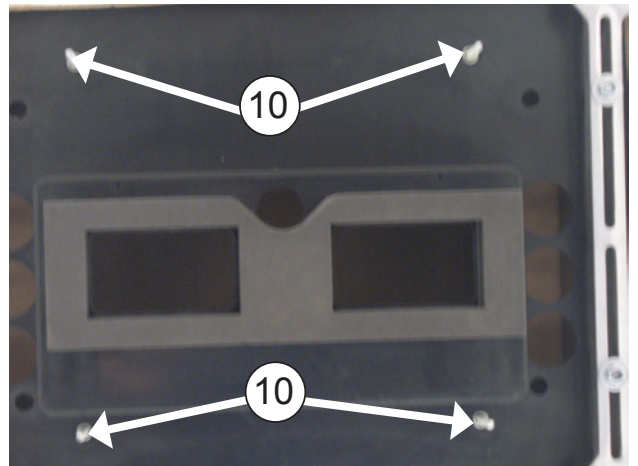
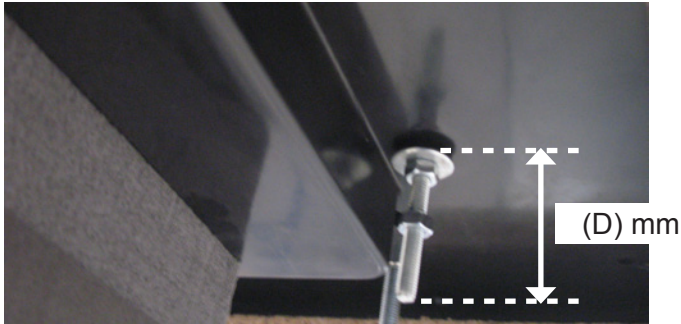

11

Position (1) Ø6 rubber washer, (1) Ø6 wide-rimmed flat washer and (1) M6 nut on each one of the M6 studs. **Tighten the nut** until the rubber washer compresses slightly.

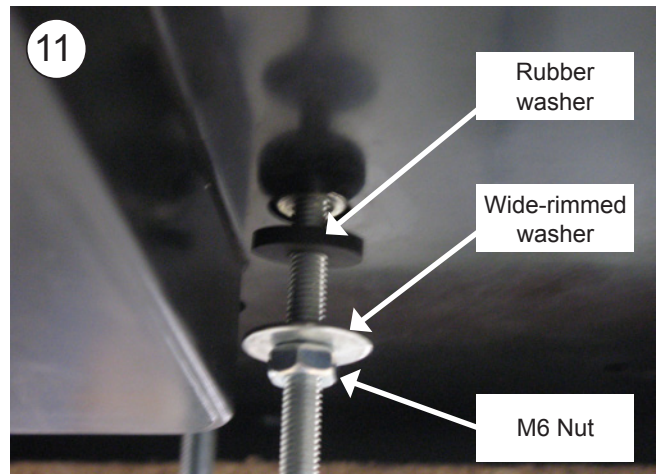

12

Position (1) M6 nut without tightening on each stud.

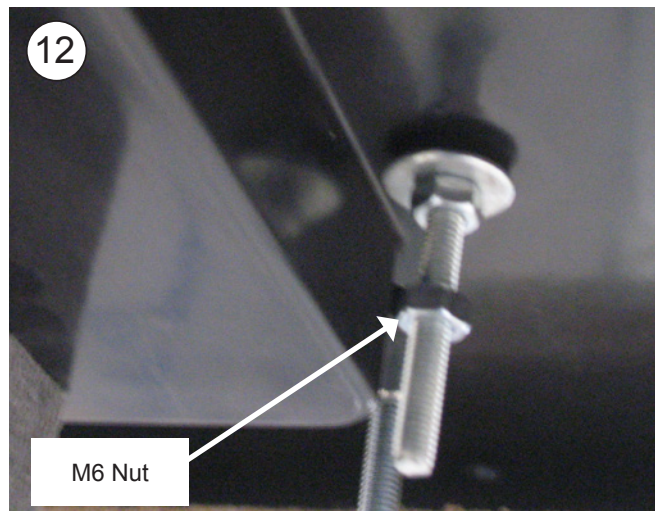



13

Between the base and the interior air distribution panel, connect (2) two-way boxes of the anti-freeze sensor (white cables) and the return air sensor (black cables), 4-way box of the blower, (2) communication cables and 8-way box of electronic control connection cables.

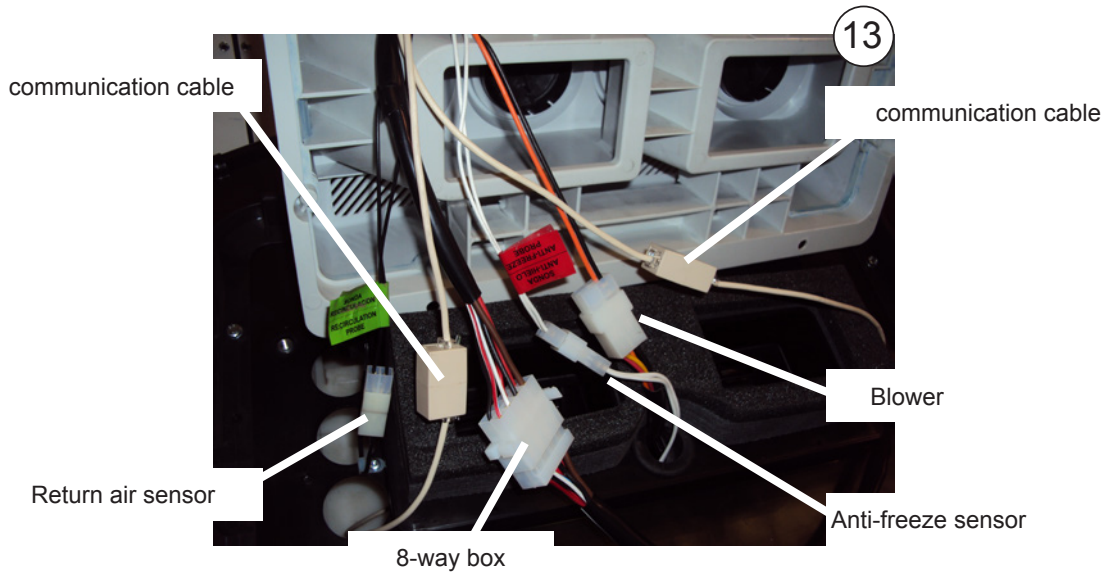

14

Position the interior air distribution panel on the front studs with (1) M6 wide-rimmed washer and (1) M6 nut on each stud. Tighten the nuts until the interior air distribution panel duct comes up against the unit's top foam.

**Important: The interior air distribution panel duct must come up against the unit's upper foam in order to prevent any leakages of air.**

**Take care to ensure the cables do not become trapped between the duct and the foam in the base of the unit.**

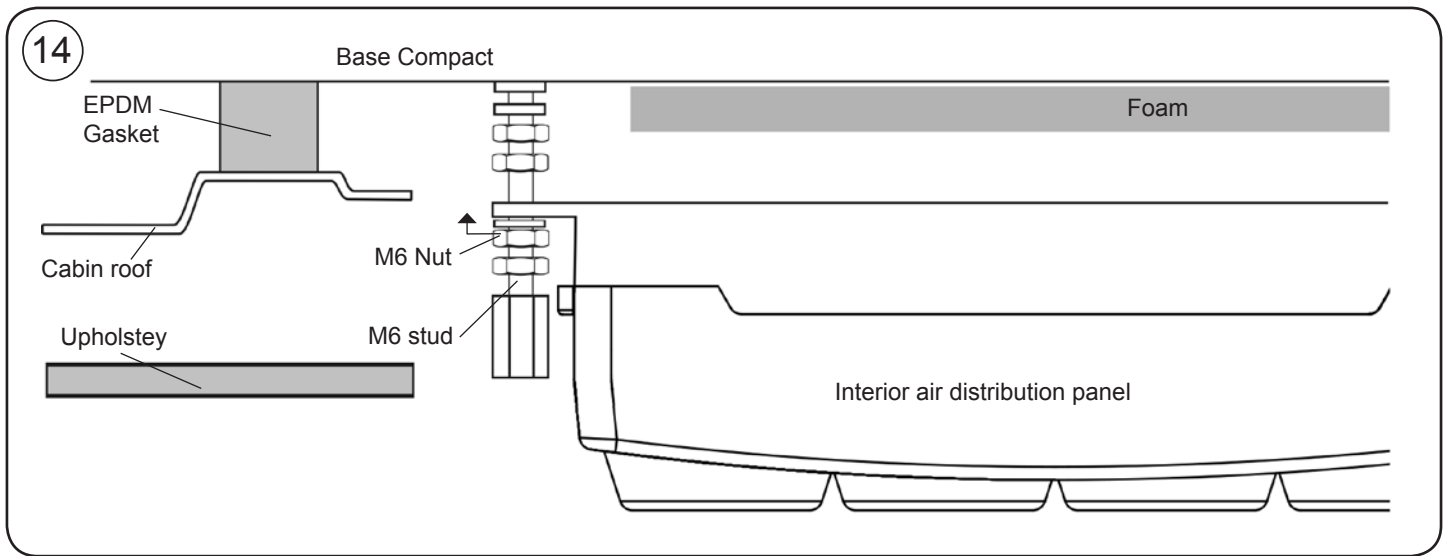

15

Tighten the nut in point 12 until it comes up against the top part of the interior air distribution panel.

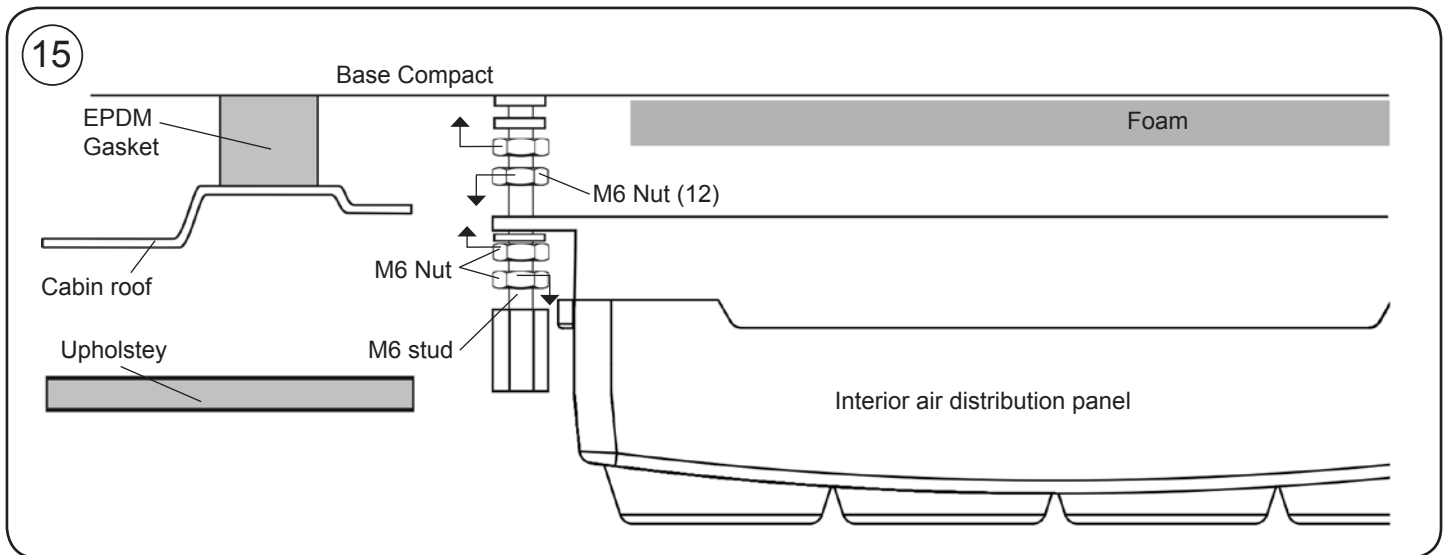

**VEHICLES WITH ORIGINAL HATCH OR PRE-MARKING IN THE ROOF FOR INSTALLATION OF THE HATCH**

**15a**

Position the console and align the equipment in the most suitable location in the cabin roof. Once aligned, remove the console.

**15b**

Secure the attachment supports by turning the nuts to tighten the exterior EPDM seal of the equipment between 3 mm and 6 mm.

**Important:** The EPDM seal must be tightened with the base of the Compact, as shown in the **diagram**, in order to prevent any leakages of water inside the cabin.

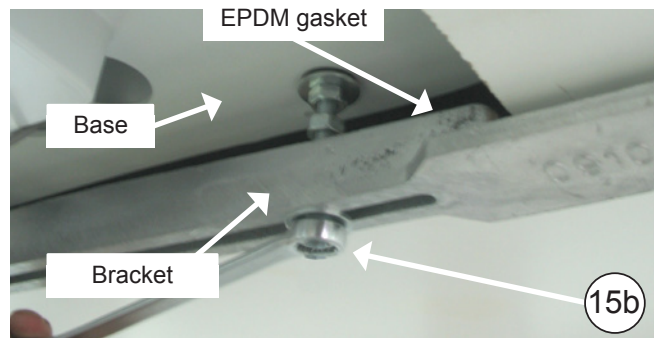
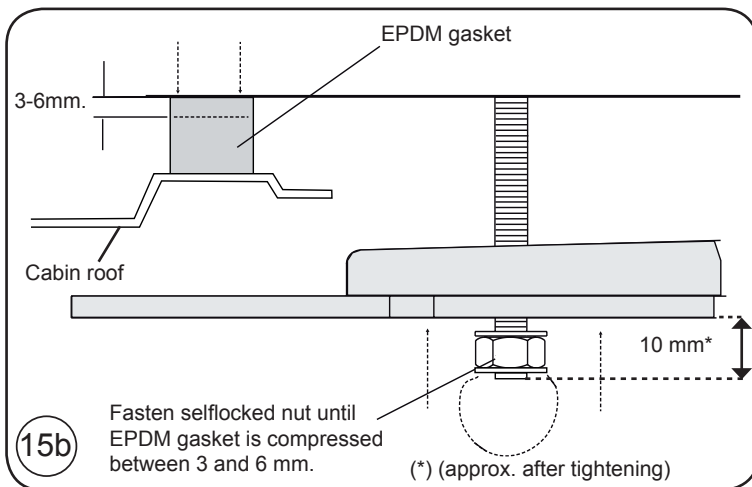

**15c**

Tighten (4) M8 nuts to the support piece and (4) to the base of the Compact.

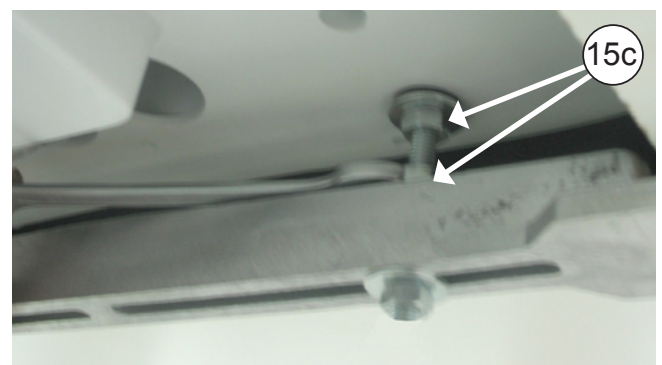

ALL MODELS

16

Position nut M6 (A) after the fastening nut of the interior air distribution panel on each stud. Screw on M6 hexagons up to 1 mm above the upholstery. Unscrew the M6 nuts (A) of this point until they come into contact with the hexagons, and tighten against them.

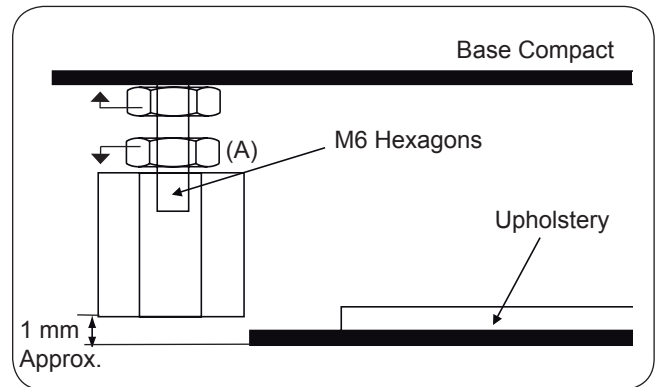

16

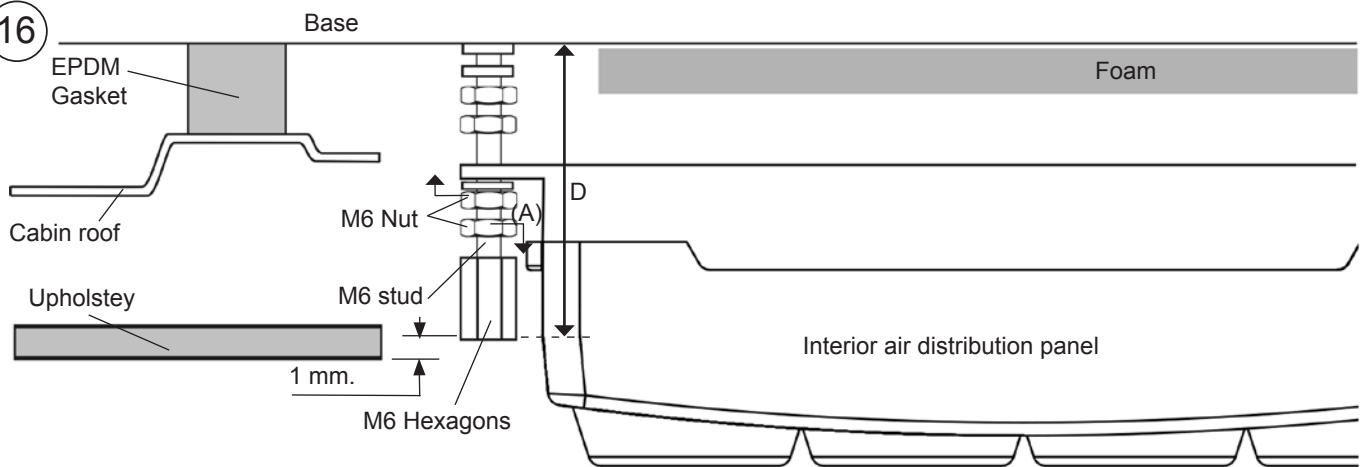

17

Position the console with (4) M6/100x15 Allen screws.

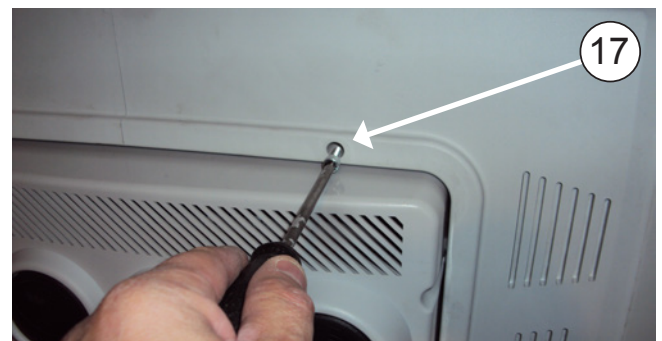

18

Cover the (4) M6/100x15 Allen screws with the M6 round plastic decorative pieces.



**VEHICLES WITH ORIGINAL HATCH AND WITHOUT PRE-MARKING IN THE ROOF FOR INSTALLATION OF THE HATCH**

**Exploded view through to support piece fastenings**

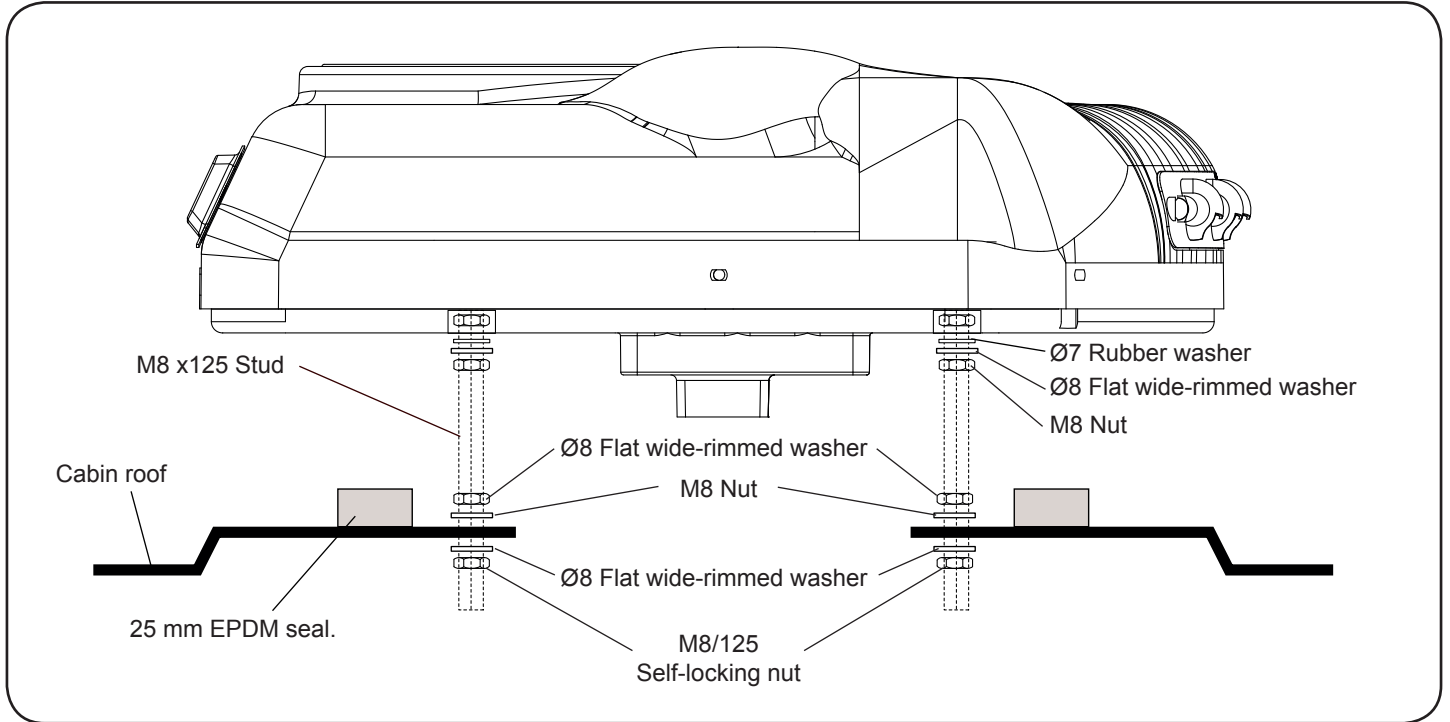

**Exploded view through to the console fastenings**

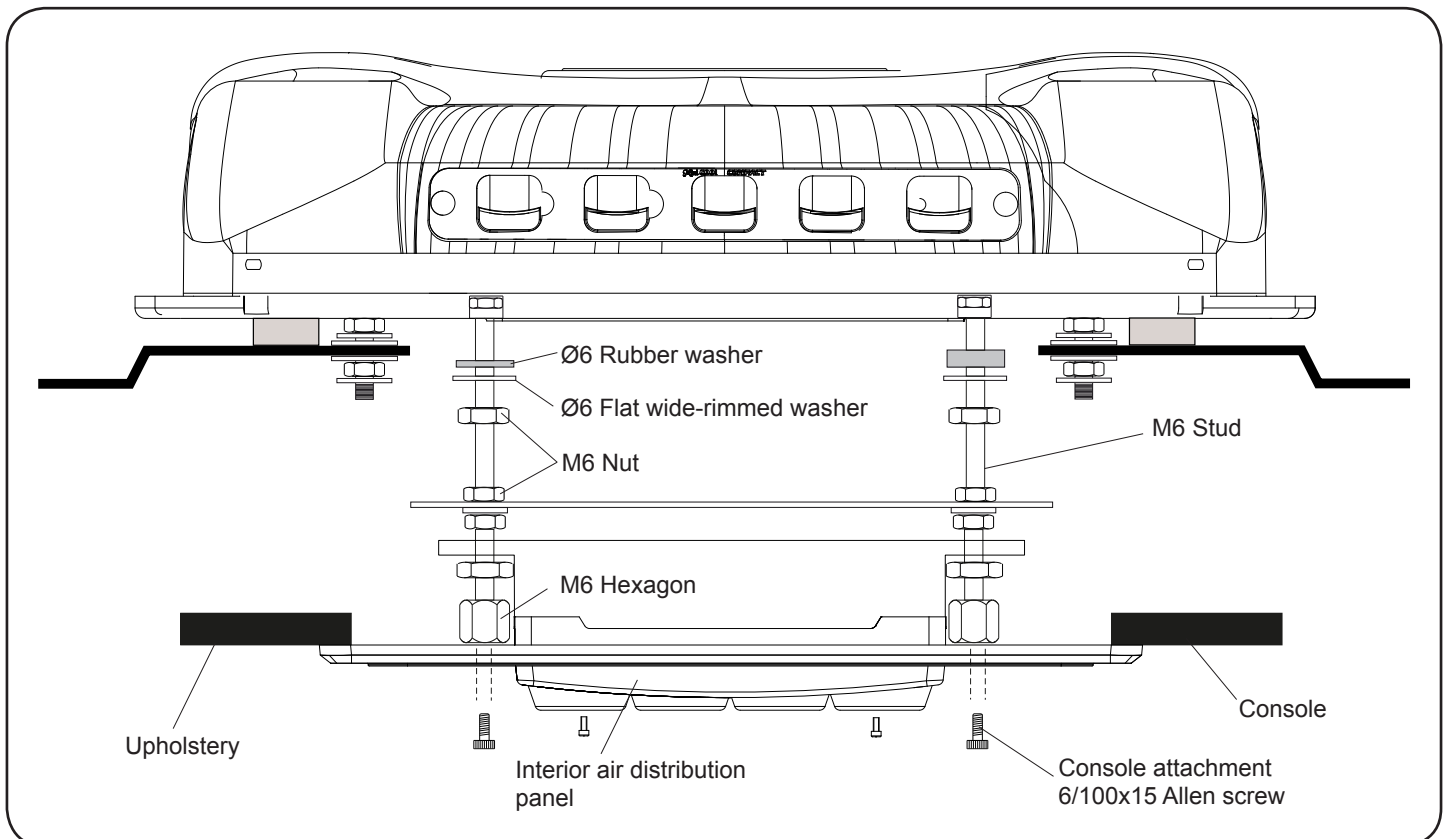



**VEHICLES WITH ORIGINAL HATCH OR PRE-MARKING IN THE ROOF FOR INSTALLATION OF THE HATCH**

**Exploded view through to support piece fastenings**

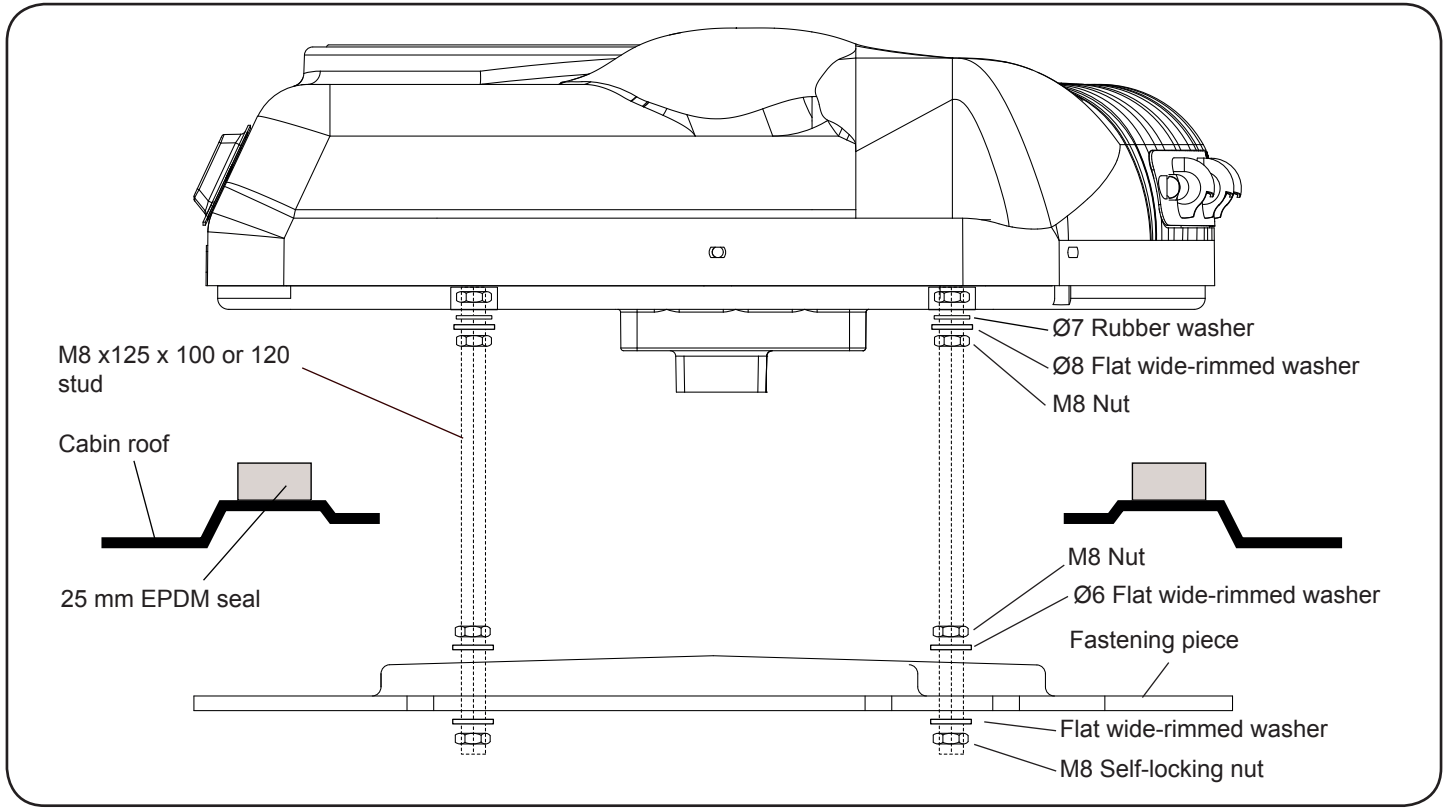

**Exploded view through to the console fastenings**

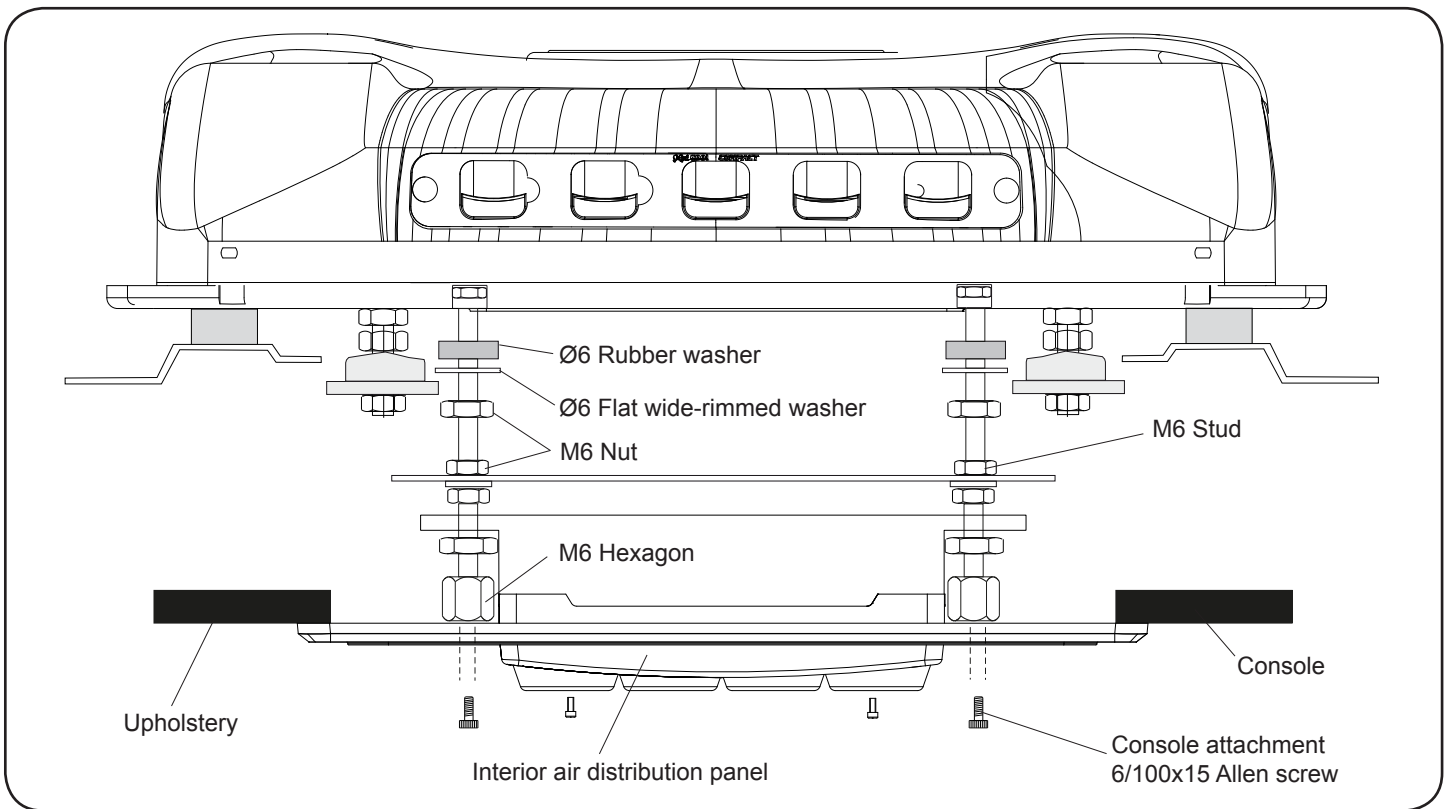

## Detailed instructions on installation of power supply cables

**1** Connect the top power cable in the rear of the unit and run to the rear of the cabin, attaching the plastic brackets and securing with flanges.

**2** Connect the bottom power cable to the battery, through the original cable run, secured with flanges, to the rear of the cabin in order to connect to the top power cable.

 **When connecting the cables, leave suitable distance in order to prevent breakage when the cabin moves.**

**Important:** Due to the unit's complex electronic regulation system, the power connection must be made directly to the vehicle's battery.

**Important:** Check the **User Manual** for starting up.

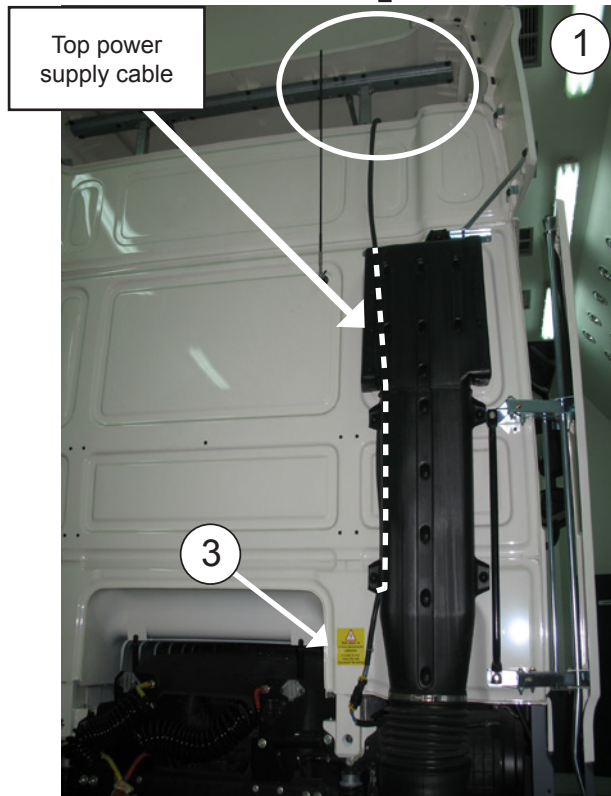
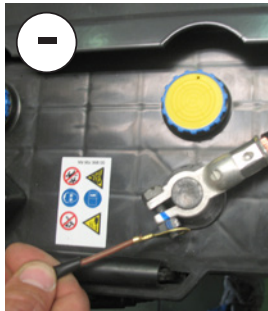
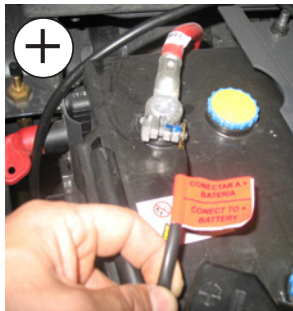
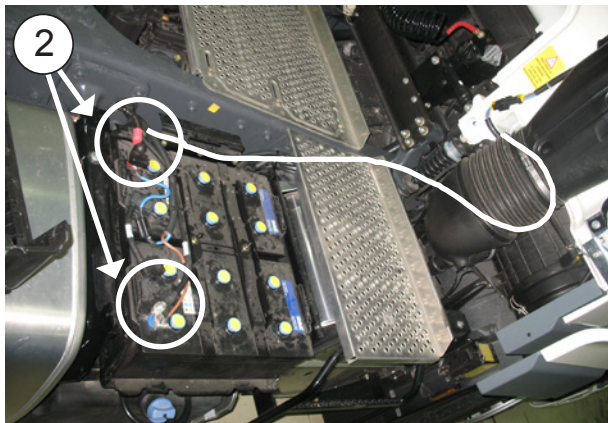

**3** Place danger stickers at the cable junction and the cabin lifting device.



Electric wiring

IMPORTANT NOTE!

Take care not to invert polarities when connecting the unit to the power supply. If this were to happen, the unit will not work and irreparable damage will be caused to the compressor modules.

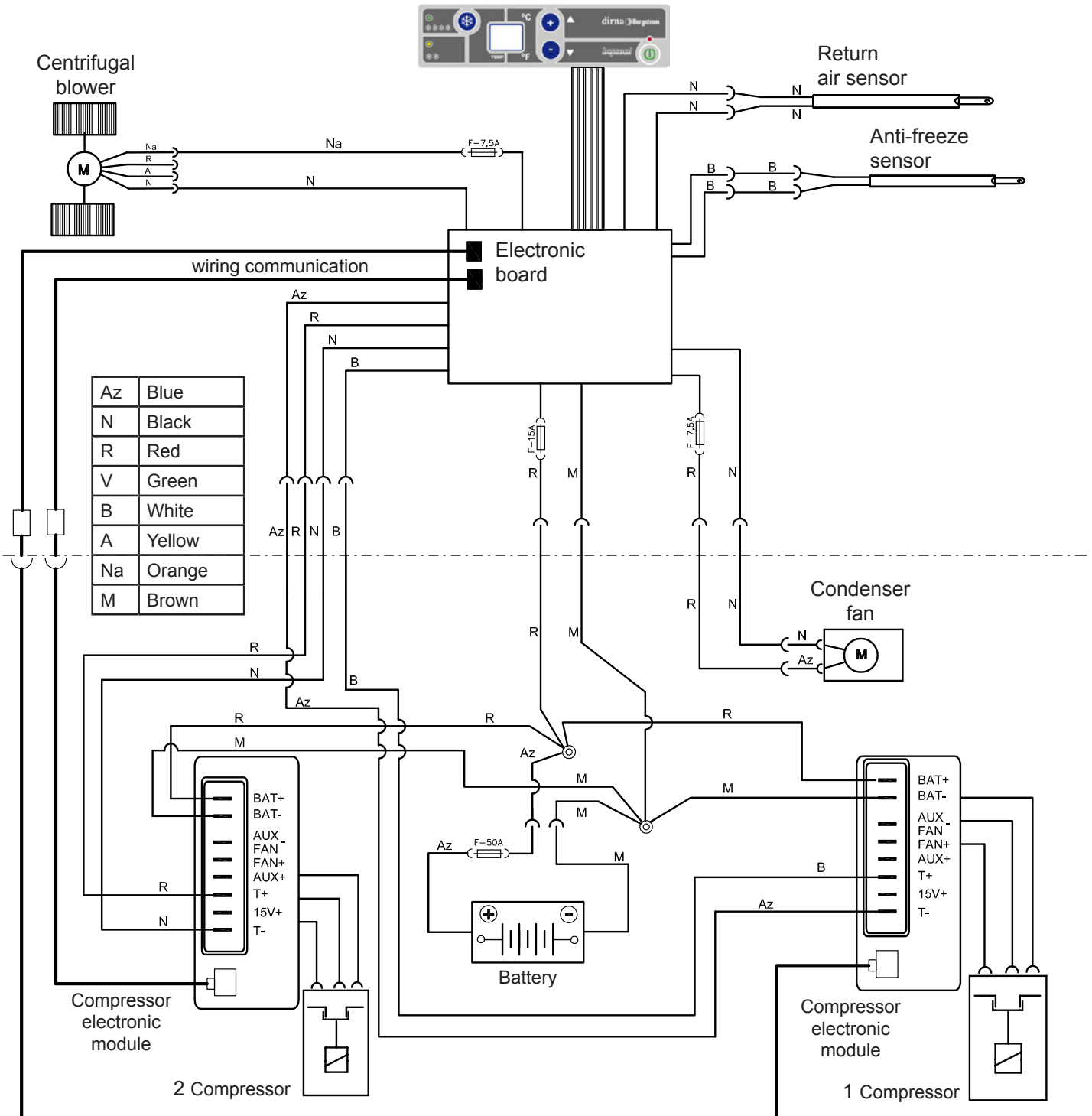



## Recommandations Pour Le Montage

- Avant de commencer le montage de l'appareil, prière de lire les instructions et de les suivre attentivement.
- Utiliser les outils convenant à chaque opération.

## Electricity

- Déconnecter la clé de contact.
- Déconnecter la batterie avant de commencer le montage.
- Vérifier le câblage des composants électriques et leur correcte installation.

## Attention

Si pendant le montage l'équipement est incliné, il faudra attendre au moins 60 minutes avant de le mettre en marche une fois qu'il aura été remis sur sa position horizontale.

## Attention

Lors de l'installation de l'appareil d'air conditionné sur le toit, il faudra protéger la partie supérieure de la cabine avec un linge ou une couverture de protection afin d'éviter les éventuelles égratignures.

Durant l'installation du **Compact**, tenir compte du fait que normalement les cabines pourvues d'écouille possède une structure suffisamment solide pour supporter le poids de l'appareil. Cependant, si ce n'est pas le cas et qu'il est nécessaire de découper le toit ou même si disposant d'écouille, la structure n'est pas suffisamment rigide (si elle était en fibre, plastique, etc.) il appartiendra à l'installateur de décider s'il faut renforcer le toit pour éviter toute déformation, rupture ou voie d'eau, etc., et prendre les mesures nécessaires à cet effet.

## Outils

Jeu de clés Torx

Jeu de clés Allen

Clé fixe 10, 13, 14

Ciseaux

Mètre

## Documentation included

Instructions de montage	1001217242
Guide de l'utilisateur	1001218019
Solution des problèmes	1001218025
Garantie	220AA10017

## Symbologie



Fragile





Attention aux coupures !





Risque électrique

## Garantie

 L'installateur devra posséder la formation pertinente en air conditionné sur véhicules.

 **dirna Bergstrom, s.l.**, ne sera pas responsable des dommages ou des bris dérivés d'une installation ou d'une manipulation incorrecte ni des modifications réalisées sans autorisation expresse par écrit.

 **Appareil pré-chargé de gaz réfrigérant. (Ne pas manipuler le circuit de gaz réfrigérant).**

 Voir la **procédure de garantie** du produit au **Diagnostic de problèmes**.

 Voir le **Guide de l'Usager** de l'appareil pour le fonctionnement correcte de la télécommande et du tableau de commande.

 Après l'installation, vous devez fournir à l'utilisateur: Manuel d'utilisation, garantie et diagnostic de pannes.





 En général, le toit des camions incorpore les renforts suffisants pour supporter le poids de l'équipement. Si ce n'est pas le cas, il faudra renforcer le toit de la cabine afin d'éviter sa déformation et pour supporter le poids de l'équipement.

 Dans les véhicules qui n'incorporent pas d'écouille, mais dont le toit inclut le marquage du contour de l'équipement pour son installation, il faudra effectuer une coupe dans le contour pré-marqué, en laissant la distance nécessaire pour la mise en place du joint. **Cette opération est toujours réalisée avec l'autorisation du client.**

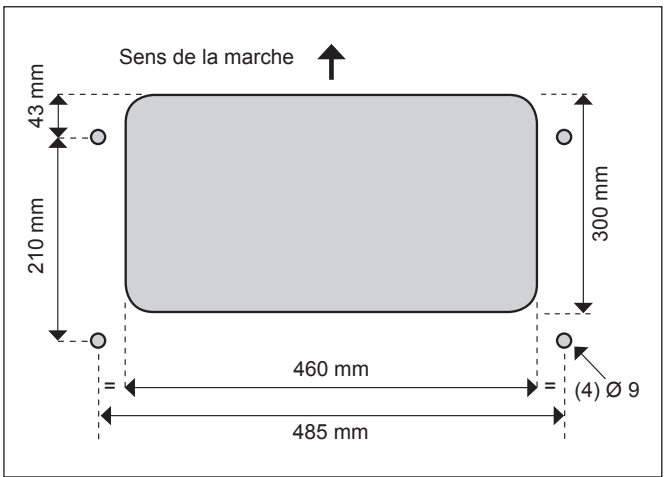
 Dans les véhicules qui n'incorporent pas d'écouille et dont le toit n'inclut pas de marquage du contour de l'équipement pour son installation, il faudra effectuer une coupe aux mesures indiquées à l'endroit choisi pour l'installation de l'équipement. **Cette opération est toujours réalisée avec l'autorisation du client.**



 Si des coupes ou des perçages sont effectués sur la plaque du véhicule, il est conseillé d'appliquer de la peinture anticorrosive sur ces derniers pour éviter la corrosion.

 Avant de commencer le montage, monter la grille d'entrée d'air frontale.



### VÉHICULES AVEC ÉCOUTILLE D'ORIGINE

**1** Démontez le couvercle de l'écoutille et les éléments de fixation et remettez l'ensemble au client.



**2** Retirez les résidus restants adhérents au toit avant de coller le joint EPDM.

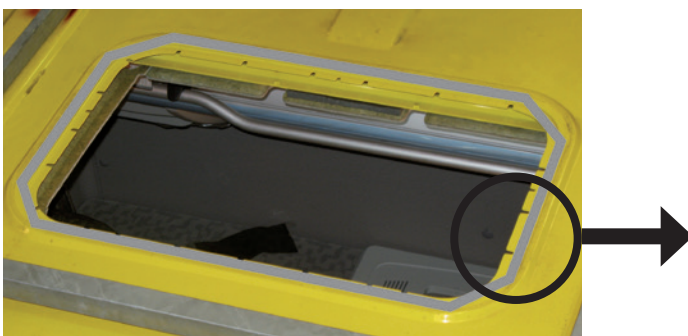

**3** Sur certains modèles, la tapisserie ne laisse pas assez d'espace pour introduire les supports de fixation, c'est pourquoi les coupes seront effectuées aux mesures indiquées sur l'image.

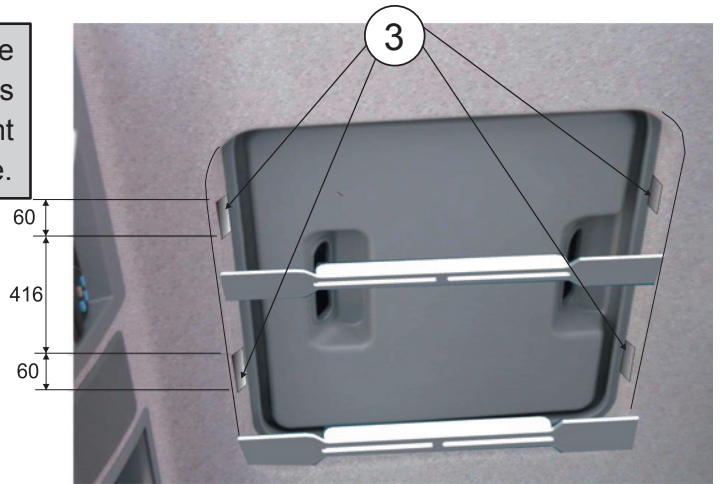

**4** Si le véhicule possède un spoiler avec barre centrale, il faudra couper la barre indiquée par des lignes de points pour installer l'équipement.  
  
Cette opération est toujours réalisée avec l'autorisation du client.

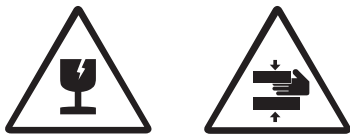

**TOUS LES MODÈLES**

**4a** Collez le joint EPDM autour du creux de l'écoutille ou de la coupe réalisée (*suivre le détail pour couper les bords finaux d'union du joint*).  
  
**Attention** : dans la coupe réalisée avec des trous, coller le joint autour des trous.

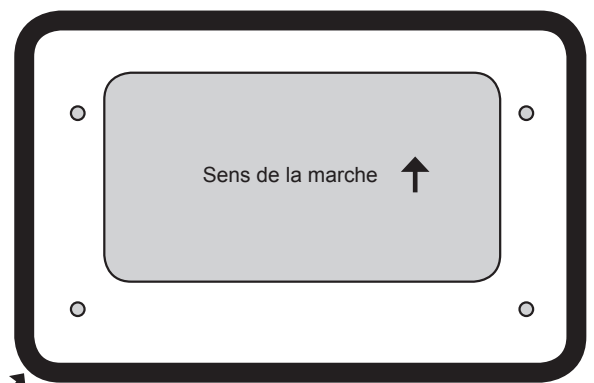
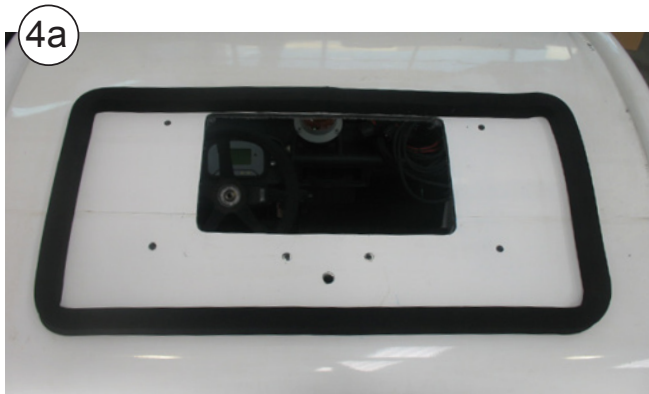
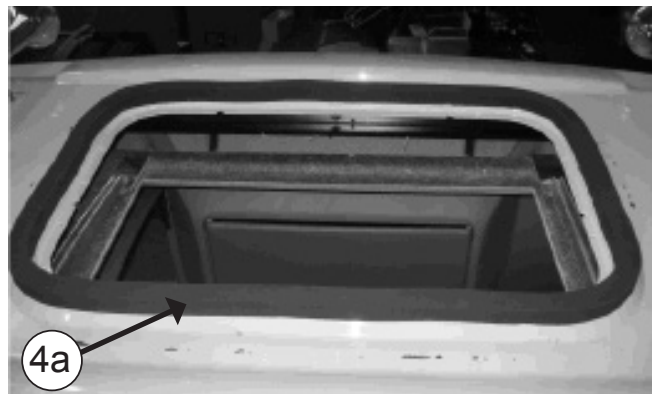



### COMMENT COUPER LE JOINT EPDM POUR EVITER LES FILTRATIONS DANS LA CABINE

- A- Coller le joint en maintenant une protection en papier de 100 mm de chaque côté.
- B- Retirer les deux morceaux de papier.
- C- Coller en faisant pression sur les deux extrémités.

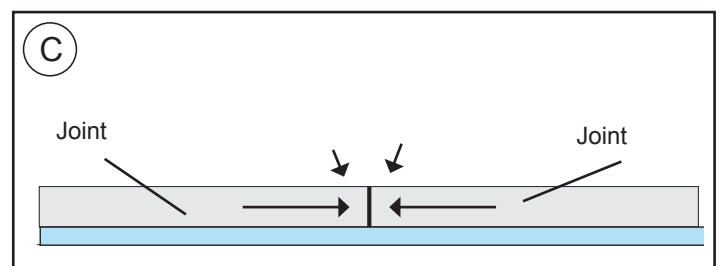
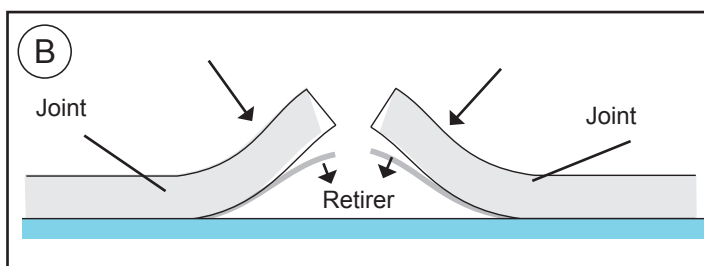
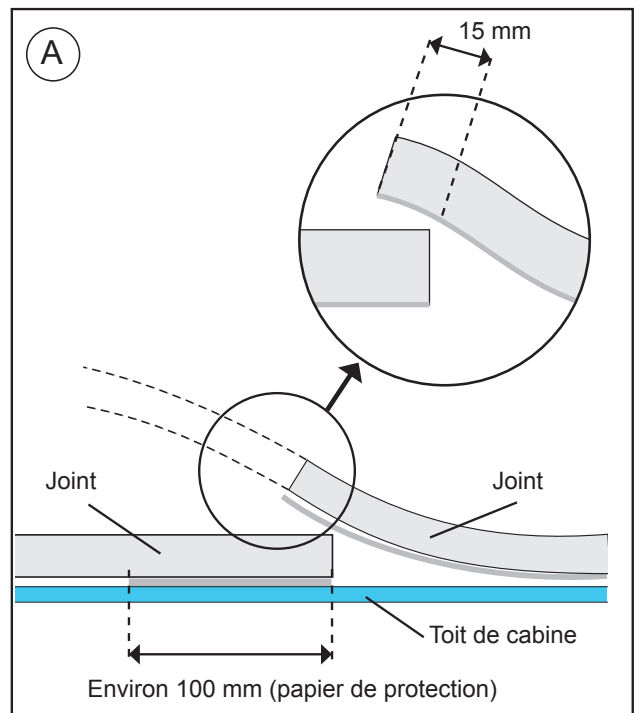

## VÉHICULES AVEC ÉCOUTILLE D'ORIGINE OU PRÉ-MARQUAGE SUR LE TOIT POUR LA MISE EN PLACE DE L'ÉCOUTILLE

5

### EXTÉRIEUR CABINE :

Placer le Compact dans le creux de l'écoutille.

**Attention !** Avant de placer l'équipement dans le creux de l'écoutille, il faut vérifier que les sorties d'écoulement ne soient pas bouchées par le joint EPDM.





**6** Placer (1) rondelle Ø 7 en caoutchouc, (1) rondelle plate Ø 8 surface large, (2) écrous M8 et (1) rondelle plate Ø 8 surface large sur chaque goujon précédent, d'après l'ordre suivant.

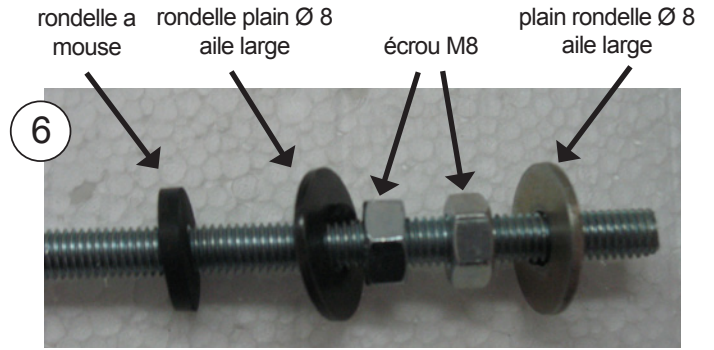

**7** **INTÉRIEUR CABINE:**  
Visser d'environ 5 mm (4) goujons 8/125x100-70 ou 120. La mesure sera choisie après avoir présenté les supports de fixation et en tenant compte que les goujons doivent ressortir de ceux-ci d'environ 20 mm par la partie inférieure.

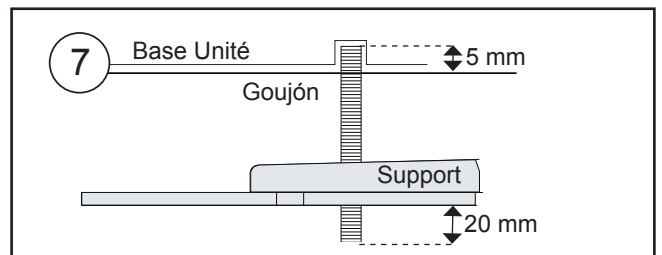

**8** Placer (2) supports de fixation, avec (1) rondelle et (1) écrou autobloquant M8, **sans serrer.**

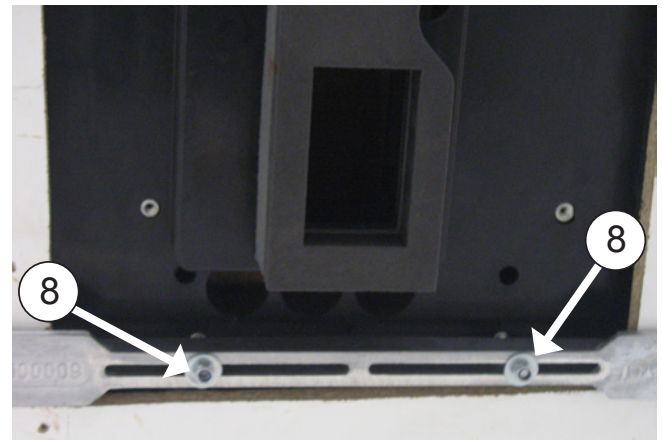
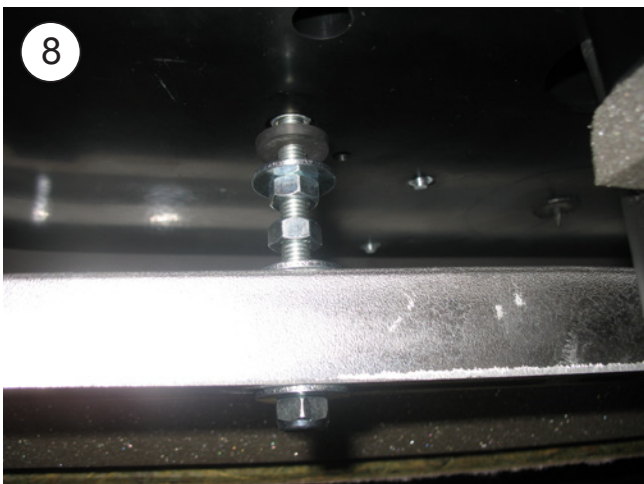



## VÉHICULES SANS ÉCOUTILLE D'ORIGINE ET SANS PRÉ-MARQUAGE SUR LE TOIT POUR LA MISE EN PLACE DE L'ÉCOUTILLE

5

Placer (1) rondelle Ø 7 en caoutchouc, (2) rondelles plates Ø 8 surface large ET (2) écrous M8 sur les (4) goujons M8 les plus courts sur la position indiquée.

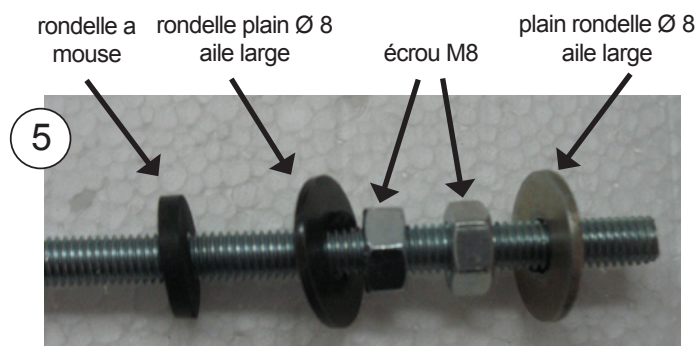

6

Visser les goujons 15 mm dans les inserts M8 de la base et serrer les écrous contre celle-ci.

**Attention :** la rondelle en caoutchouc reste contre la base de l'équipement.



7

Placer le Compact sur la coupe effectuée. Introduire les goujons dans les trous de Ø 9 (\*) réalisés en même temps que la coupe.

**Attention :** vérifier que les sorties d'écoulement soient en dehors du joint EPDM et qu'elles ne soient pas bouchées par ce dernier.

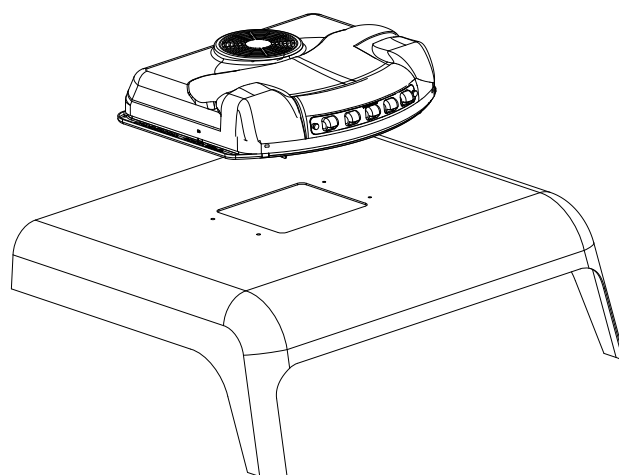

8

Placer (1) rondelle plate Ø 8 surface large et (1) écrou M8/125 autobloquant et serrer jusqu'à ce que le joint EPDM se comprime entre 3 et 6 mm. Serrer ensuite l'écrou restant au-dessus du toit de la cabine contre ce dernier.

**Vérifier l'étanchéité du joint EPDM entre la base de l'équipement et le toit de la cabine!**

**Si besoin, renforcer le toit de la cabine en plaçant un support collé à la partie inférieure du toit de cabine et en le fixant avec les rondelles Ø 8 et les écrous M8/125 autobloquants.**



Support de renfort

TOUS LES MODÈLES

9

Placer le canalisateur en caoutchouc mousse en laissant la partie la plus molle sur la base de l'équipement.

**Attention** : en fonction de la cabine, il est possible de devoir utiliser les (2) canalisateurs fournis pour que le panneau de distribution d'air reste totalement ajusté par rapport à ces derniers.

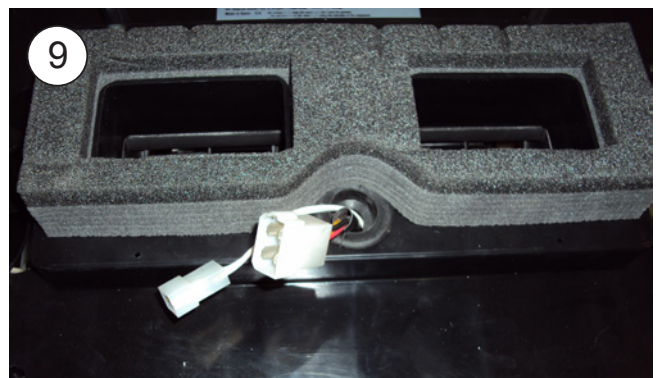

10

Visser de 10 mm (4) goujons M6 x 55 ou 80, à l'emplacement indiqué, selon la distance (D) du schéma du point 16.

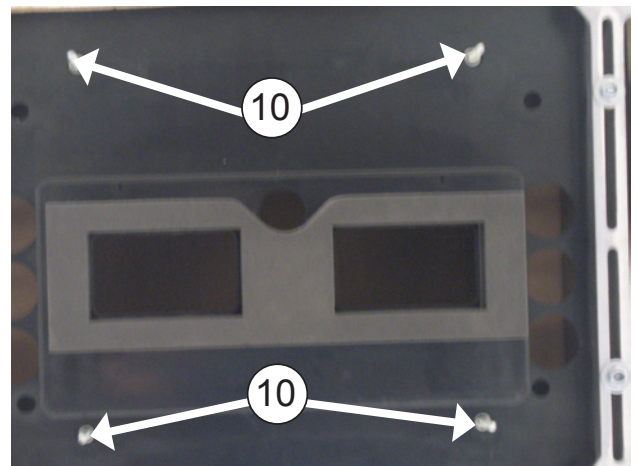
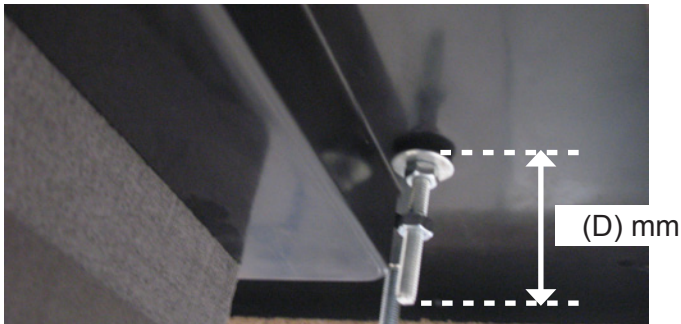

11

Placer (1) rondelle Ø6 en caoutchouc, (1) rondelle plate Ø6 surface large et (1) écrou M6 sur chaque goujon de M6. Ensuite, **serrer l'écrou** jusqu'à ce que la rondelle en caoutchouc reste légèrement opprimée.

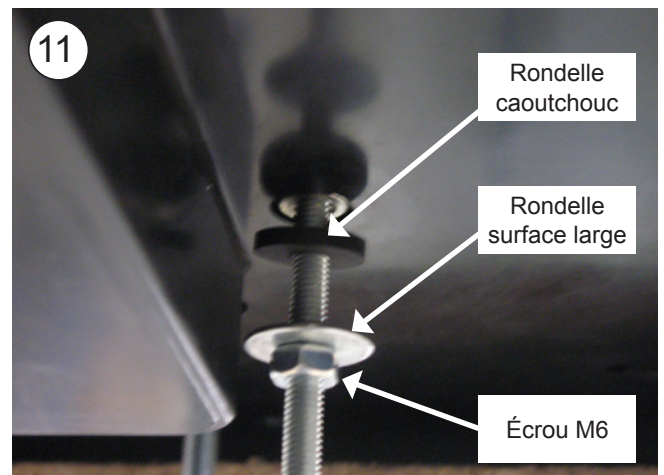

12

Placer (1) écrou M6 sans serrer sur chaque goujon.

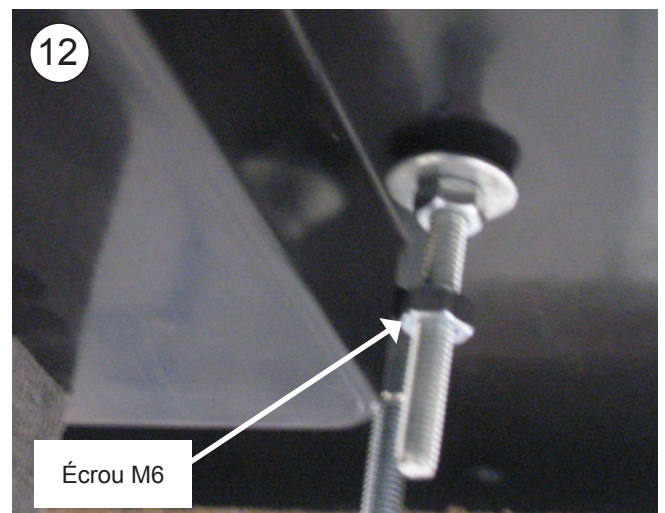

13

Entre la base et le panneau inférieur de distribution d'air, connecter (2) boîtes à deux voies de capteur antigel (câbles blancs) et capteur d'air de retour (câbles noirs), la boîte à 4 voies du souffleur, (2) câbles de communication et la boîte à 8 voies de câblage à la connexion avec contrôle électronique.

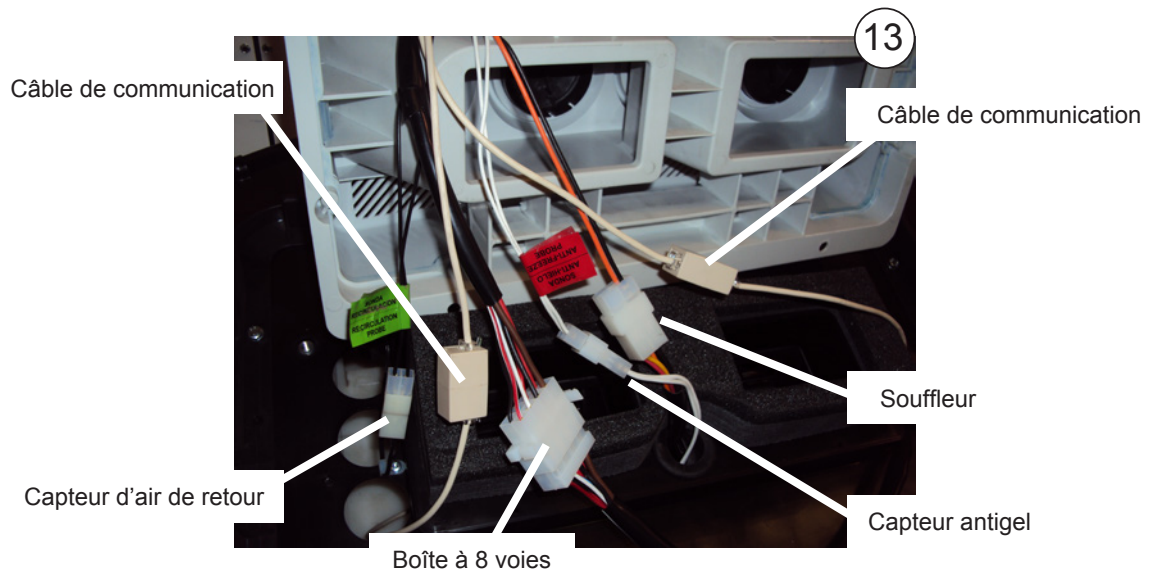



14

Placer le panneau intérieur de distribution d'air dans les goujons précédents avec (1) rondelle M6 surface large et (1) écrou M6 sur chaque goujon. Serrer les écrous jusqu'à ce que le canalisateur du panneau intérieur de distribution d'air heurte le caoutchouc mousse supérieur de l'équipement.

**Important : le canalisateur du panneau intérieur de distribution d'air doit heurter le caoutchouc mousse supérieur de l'équipement pour éviter des fuites d'air.**

**Attention de ne pas coincer les câblages entre le canalisateur et le caoutchouc mousse placé dans la base de l'équipement.**

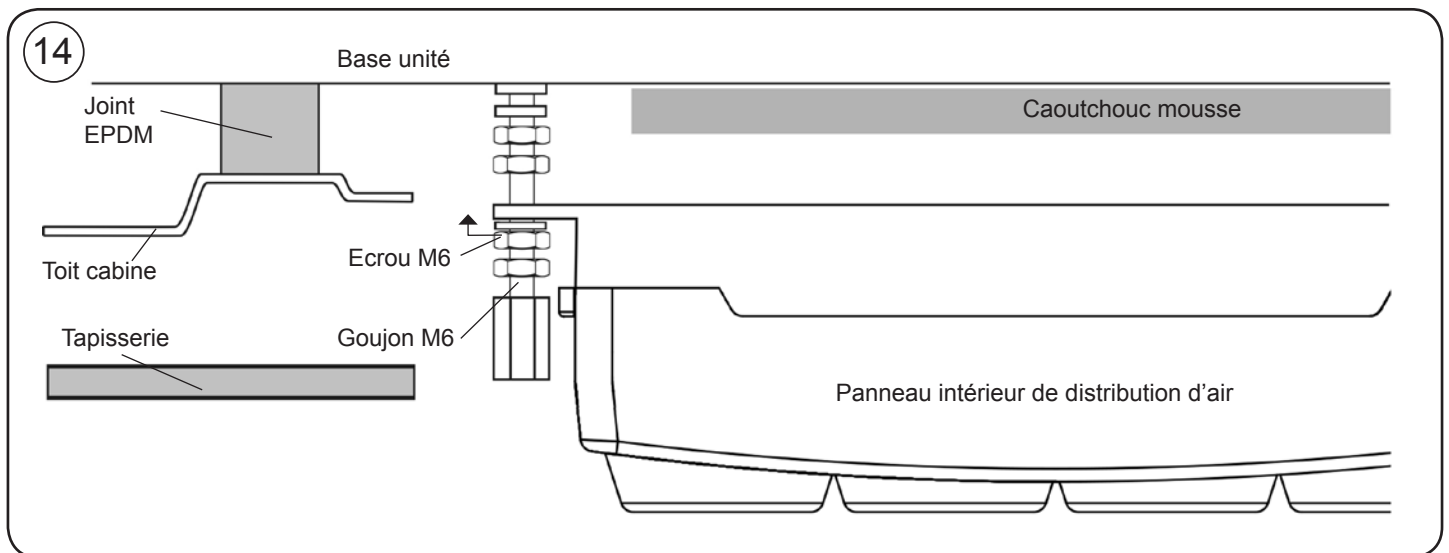

15

Serrer l'écrou du point 12 jusqu'à atteindre la partie supérieure du panneau intérieur de distribution d'air.

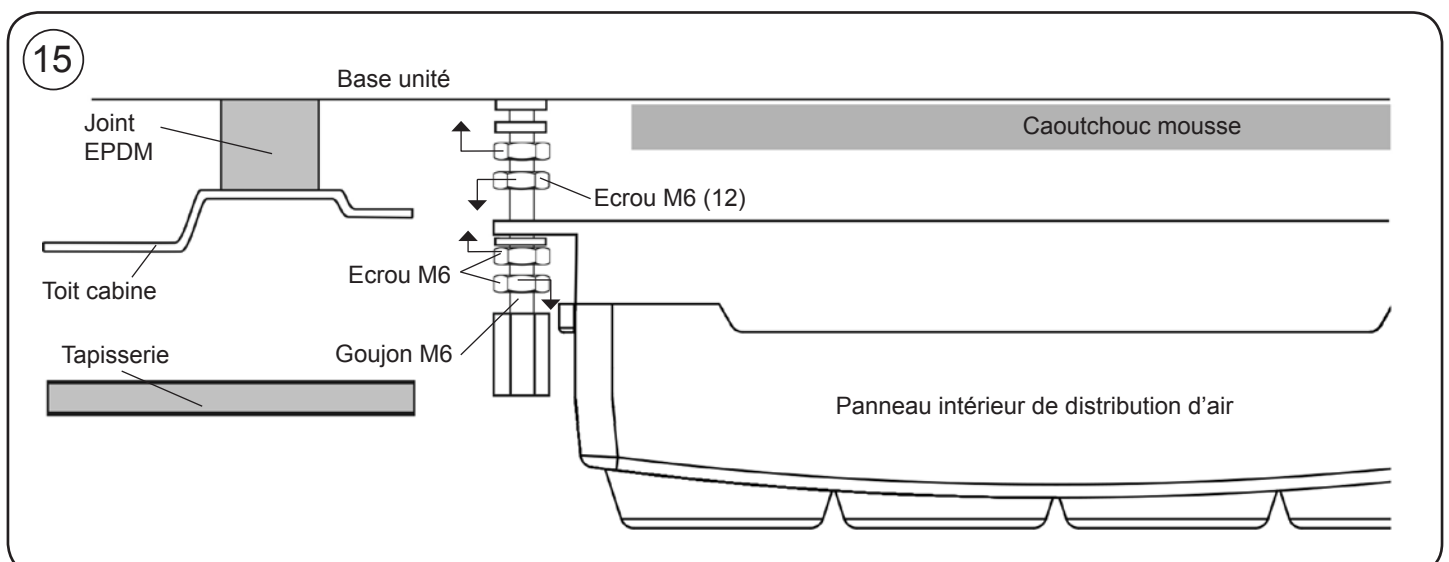



VÉHICULES AVEC ÉCOUTILLE D'ORIGINE OU PRÉ-MARQUAGE SUR LE TOIT POUR LA MISE EN PLACE DE L'ÉCOUTILLE

15a

Présenter la console et centrer l'équipement à l'emplacement le plus indiqué du toit de la cabine. Une fois centrée, la console peut être retirée.

15b

Fixer les supports de fixation en serrant les écrous jusqu'au serrage du joint EPDM extérieur de l'équipement entre 3 et 6 mm.

**Important :** Pour éviter de possibles filtrations d'eau à l'intérieur de la cabine, il faut assurer le serrage du joint EPDM avec la base du Compact, comme indique le **schéma**.

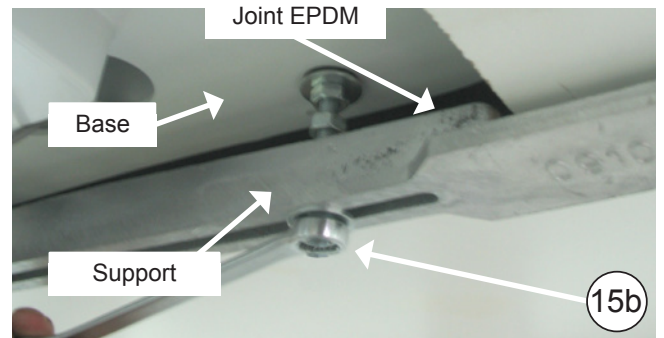
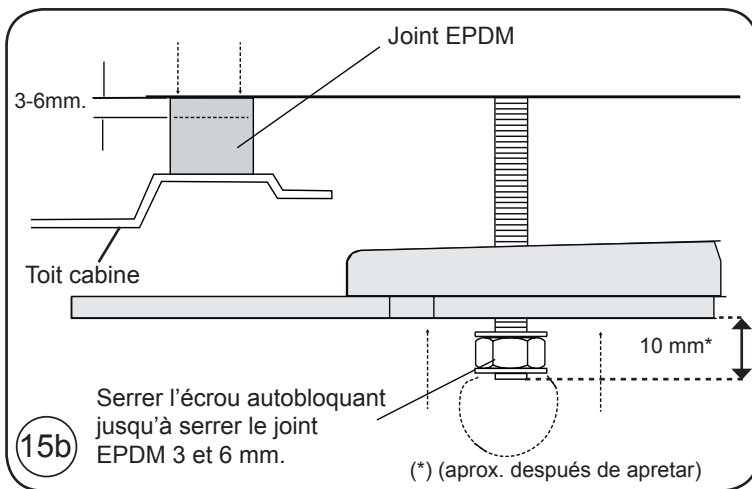

15c

Serrer (4) écrous M8 au support et (4) à la base du Compact.

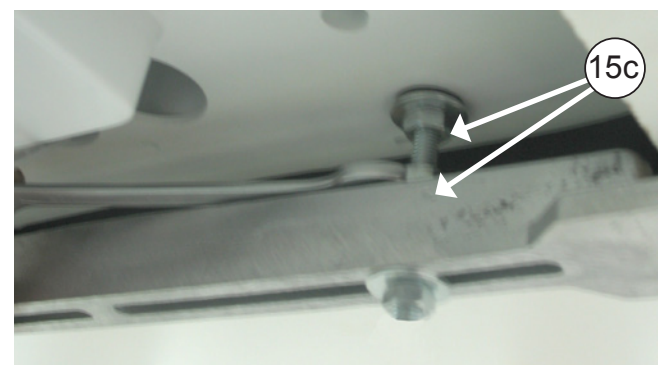

## TOUS LES MODÈLES

16

Placer un écrou M6 (A) après l'écrou de fixation du panneau intérieur de distribution d'air dans chaque goujon. Placer les hexagones M6 en vissant jusqu'à ce qu'il reste 1 mm au-dessus de la tapisserie. Dévisser les écrous M6 (A) de ce point jusqu'à atteindre les hexagones et serrer contre eux.

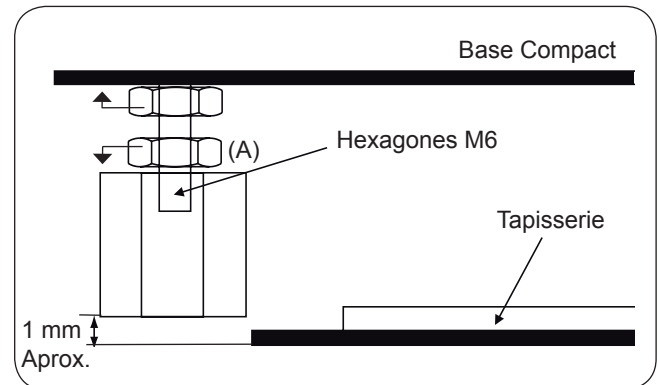

16

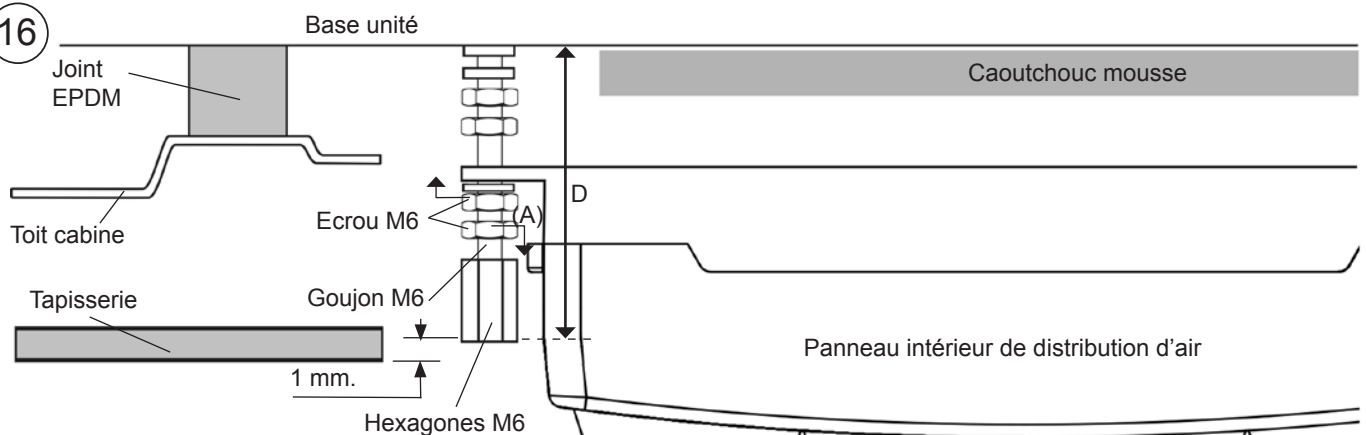

17

Placer la console avec (4) vis M6/100x15 allen.

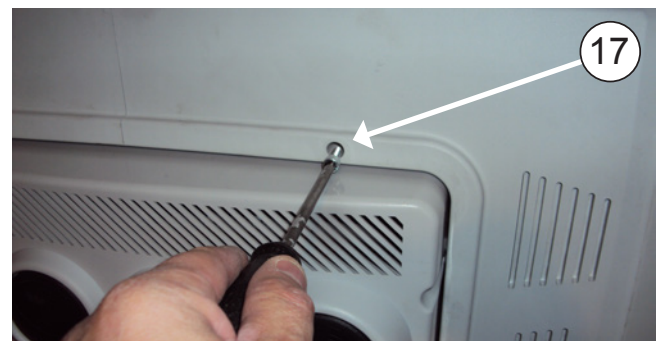

18

Couvrir les (4) vis M6/100x15 allen avec les enjoliveurs ronds de M6 en plastique.



VÉHICULES SANS ÉCOUTILLE D'ORIGINE ET SANS PRÉ-MARQUAGE SUR LE TOIT POUR LA MISE EN PLACE DE L'ÉCOUTILLE

Vue amplifiée jusqu'à la fixation des supports

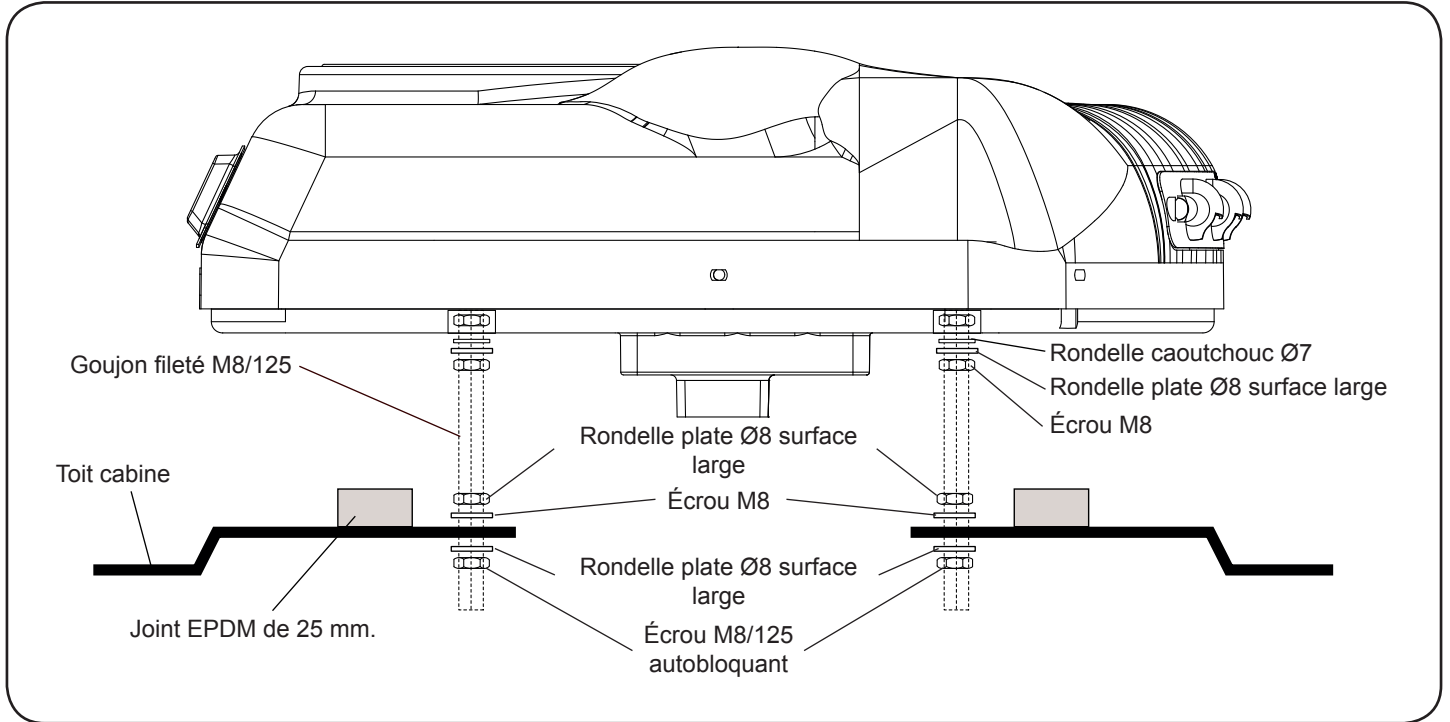

Vue amplifiée jusqu'à la fixation des consoles

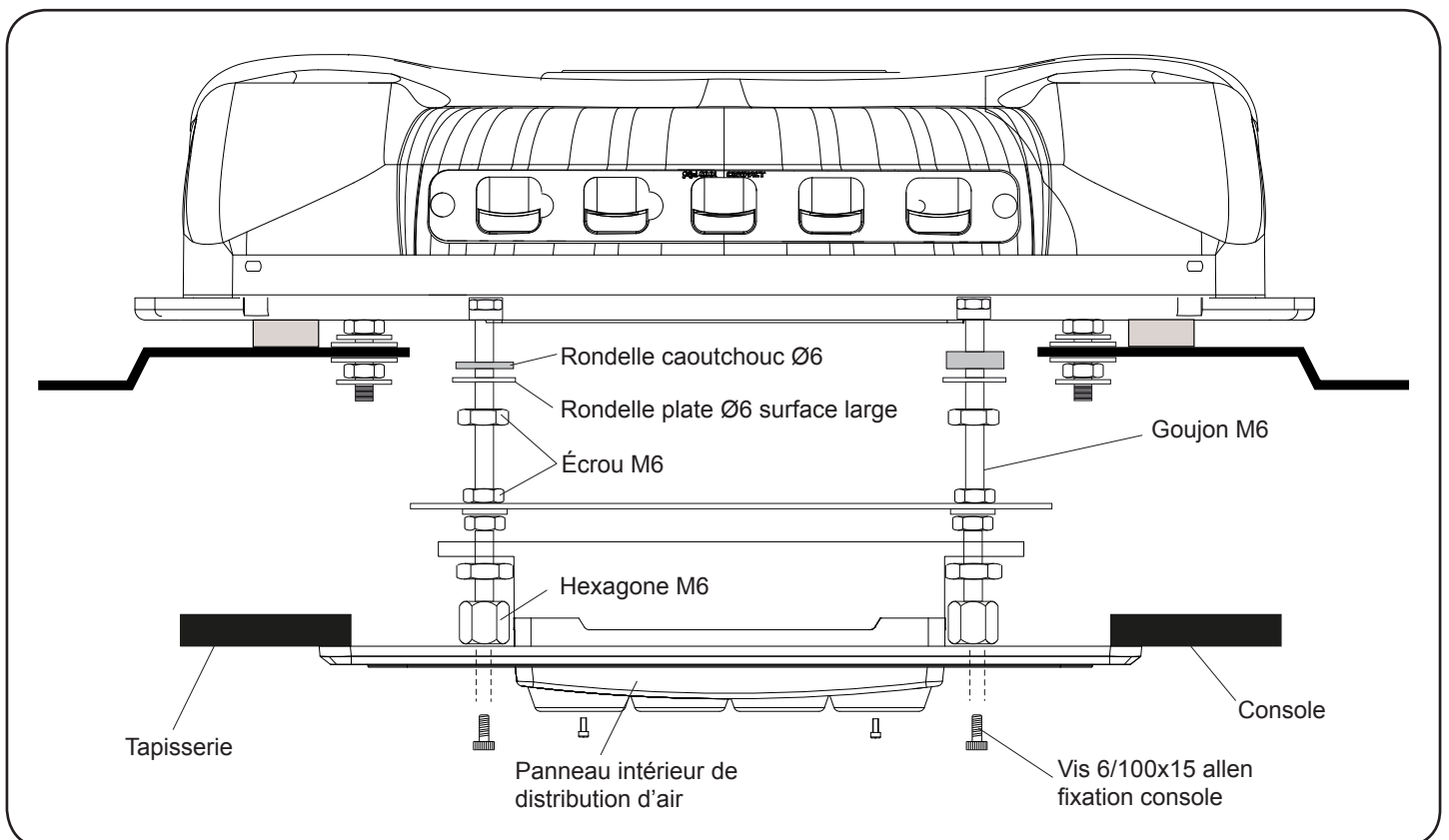

## VÉHICULES AVEC ÉCOUTILLE D'ORIGINE OU PRÉ-MARQUAGE SUR LE TOIT POUR LA MISE EN PLACE DE L'ÉCOUTILLE

### Vue amplifiée jusqu'à la fixation des supports

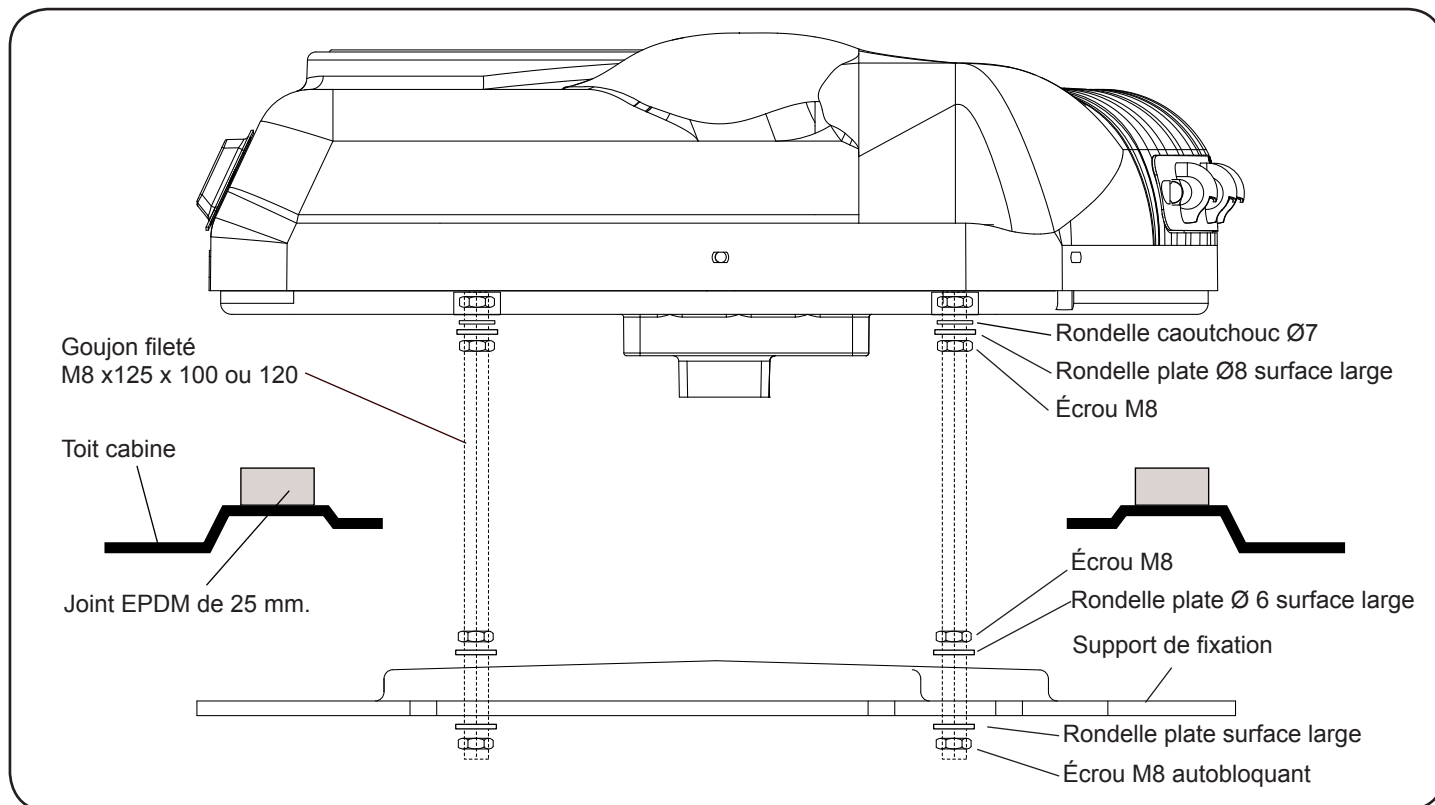

### Vue amplifiée jusqu'à la fixation des consoles

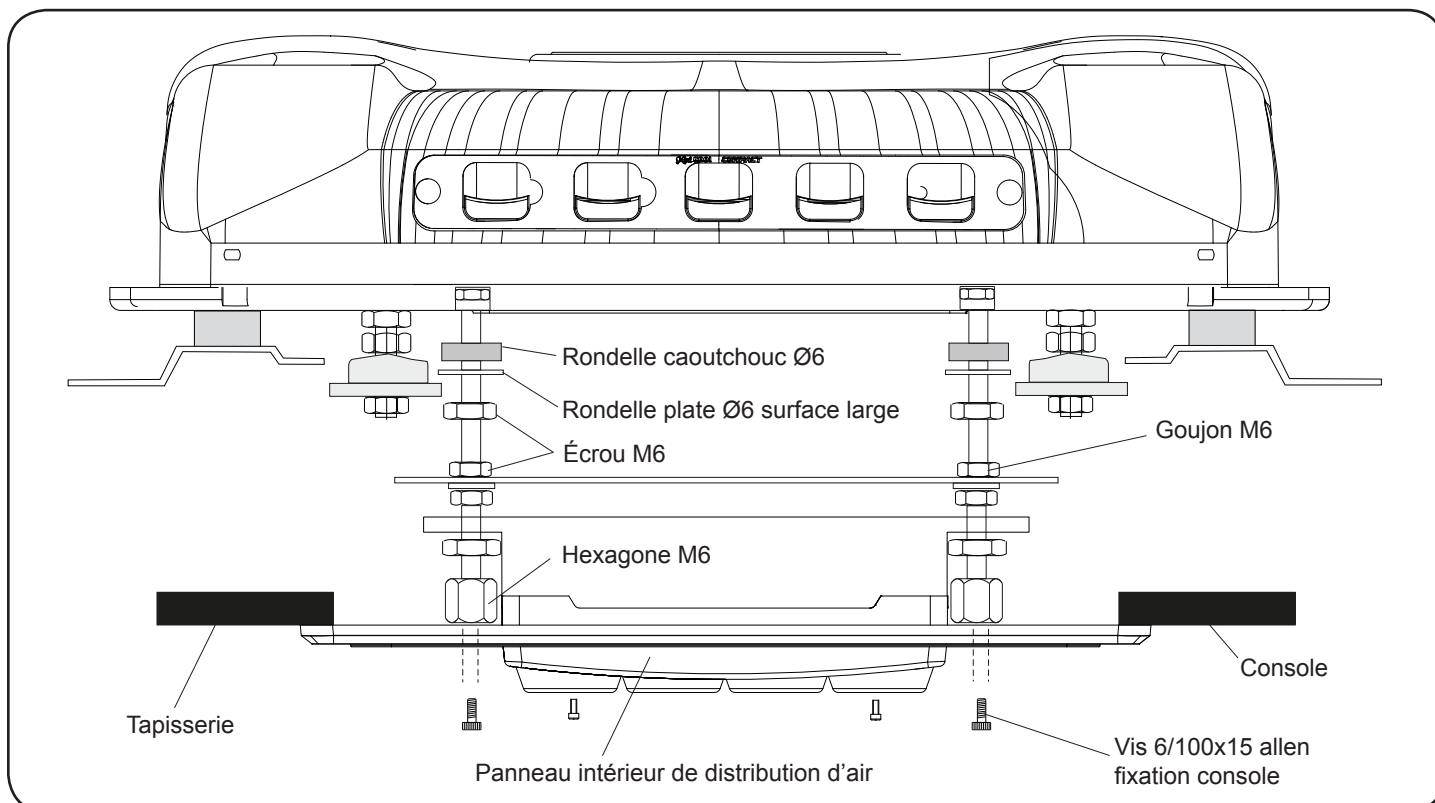



## Instructions détaillées sur l'installation du câblage d'alimentation

**1** Connecter le câble d'alimentation supérieur à la partie arrière de l'équipement et le porter par la partie postérieure de la cabine en collant les supports en plastique et en le fixant avec des brides.

**2** Connecter le câble d'alimentation inférieur à la batterie, en le portant par le passage des câblages original, fixé avec des brides, jusqu'à la partie postérieure de la cabine pour connecter avec le câble d'alimentation supérieur.



**Au moment de connecter les câblages, prévoir une distance suffisante pour éviter leur cassure provoquée par le mouvement de la cabine !**

**Important :** étant donné la complexité du système de réglage électronique de l'équipement, la prise de courant doit être effectuée directement à la batterie du véhicule.

**Important :** consultez le **Manuel de l'Usager** pour la mise en marche.

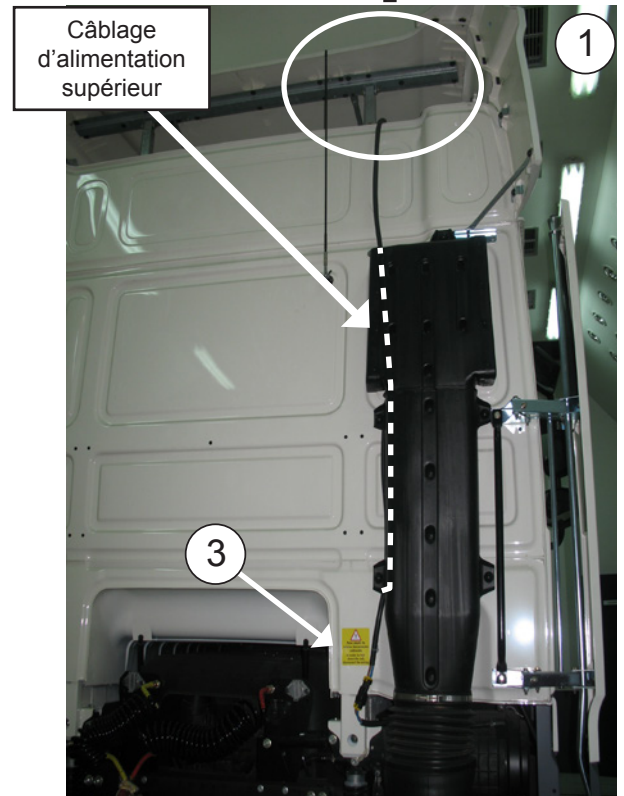
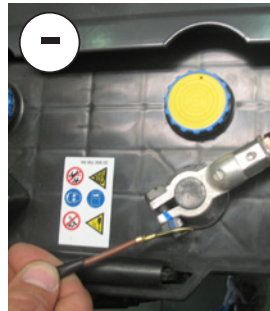
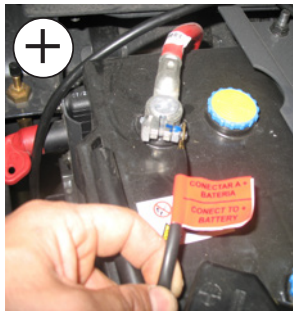
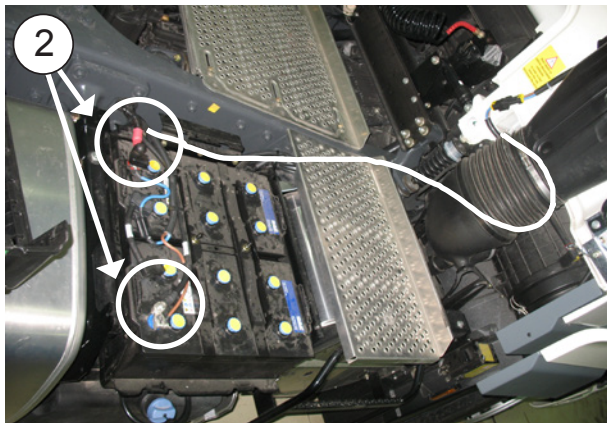

**3** Placer les adhésifs de danger dans l'union du câblage et sur le dispositif de levage de la cabine.

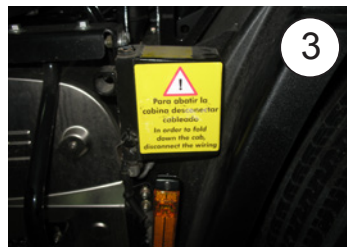



# Câblage électrique

## AVERTISSEMENT IMPORTANT!

**Attention!** Ne pas inverser les polarités dans la connexion de l'alimentation à l'équipement. Si cela se produisait, la plaque ne s'allumerait pas, l'équipement ne fonctionnerait pas et des dommages irréparables se produiraient sur les modules des compresseurs.

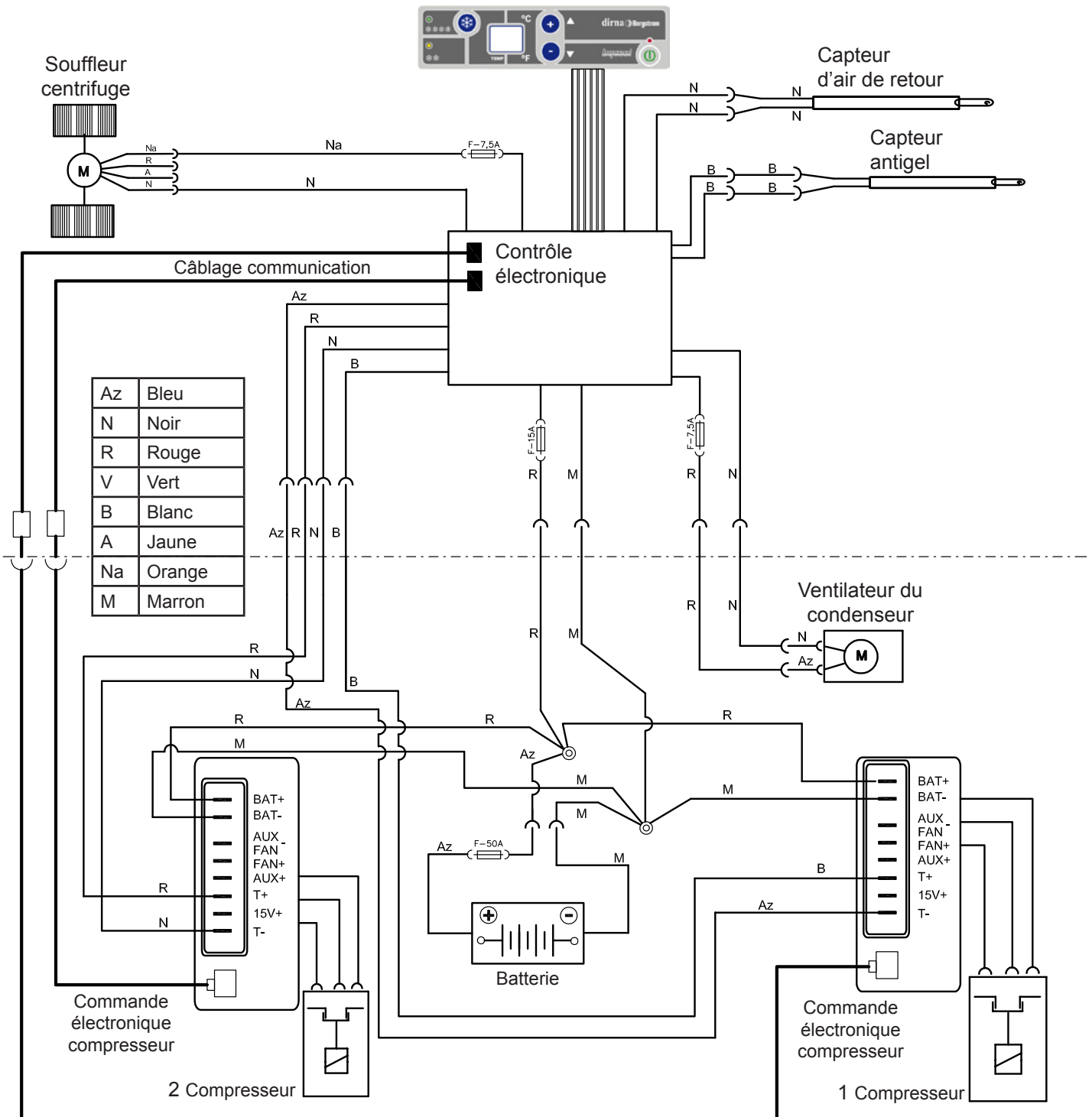



### Empfehlungen Zur montage

- Vor und während der Montage bitte diese Anweisungen lesen und beachten.
- Benutzen Sie für jeden Arbeitsschritt die geeigneten Werkzeuge.

### Elektrizität

- Zündschlüssel abziehen.
- Vor Montagebeginn die Batterie abklemmen.
- Den ordnungsgemäßen Anschluss und die korrekte Installation der Elektrokomponenten überprüfen.

### **Achtung**

**Sollte sich das Gerät während der Montage neigen, muss man mindestens 60 Minuten warten, nachdem es wieder in die horizontale Lage gebracht wurde, um es wieder einzuschalten.**

### **Achtung**

Wird die Klimaanlage im Kabinendach installiert, muss der obere Teil der Kabine mit einem Tuch oder einer Decke gegen eventuelle Kratzer geschützt werden. Bei der Installation der **Compact** auf dem Kabinendach muss darauf geachtet werden, dass mit Luken ausgestattete Kabinen über eine ausreichend stabile Struktur verfügen, um das Gewicht des Geräts stand zu halten. Sollte das Fahrzeug über keine Luke verfügen und sollte es notwendig sein, das Kabinendach aufzuschneiden, bzw. sollte die vorhandene Struktur nicht ausreichend stabil sein (z.B. wenn sie aus Faser, Kunststoff usw. hergestellt ist), obliegt es dem Installateur zu entscheiden, ob das Kabinendach zur Vermeidung von Verformungen, Brüchen, undichten Stellen usw. verstärkt werden muss, und die hierfür notwendigen Mittel bereit zu stellen.



### Werkzeuge

- Torx-Schraubenschlüssel
- Inbusschraubenschlüssel
- 10er, 13er, 14er Schraubenschlüssel
- Schere
- Metermaß

### Mitgelieferte unterlagen

Montageanweisungen	1001217242
Benutzerleitfaden	1001218019
Fehlerdiagnose	1001218025
Garantie	220AA10017

### Symbologie

-  Fragile
-  Attention aux coupures !
-  Risque électrique

### **Warnhinweise**

-  Der Installateur muss im Bereich Fahrzeug-Klimaanlagen ausreichend geschult sein.
-  **dirna Bergstrom, s.l.** übernimmt keine Verantwortung für Schäden oder Brüche aufgrund einer nicht ordnungsgemäßen Installation oder Bedienung des Geräts oder den Austausch von Teilen bzw. Umbauten, die ohne die erforderliche schriftliche Genehmigung durchgeführt wurden.
-  **Mit Kältemittel vorgefülltes Gerät. (Kältemittelkreislauf nicht manipulieren).**
-  Siehe **Garantieverfahren** des Produkts in der **Fehlerdiagnose**.
-  Siehe **Benutzerleitfaden** des Geräts für den ordnungsgemäßen Betrieb der Fernbedienung und des Bedienfelds.
-  Die folgenden Unterlagen müssen dem Benutzer nach der Installation ausgehändigt werden: **Benutzerleitfaden, Garantie und Fehlerdiagnose.**

 Generell sind die Kabinendächer ausreichend verstärkt, um das Gewicht der Anlage zu tragen. Sollte das nicht so sein, muss das Kabinendach verstärkt werden, damit es sich nicht verformt und das Gewicht der Anlage aushält.

 Bei Fahrzeugen ohne Luke, an denen aber am Dach die Kontur markiert ist, um die Luke anzubringen, muss an der vormarkierten Kontur geschnitten werden und dabei der notwendige Abstand für die Anbringung der Dichtung belassen werden. **Diese Tätigkeit wird immer mit Genehmigung des Kunden durchgeführt.**

 Bei Fahrzeugen ohne Luke und auch ohne Konturmarkierung am Dach für deren Einbau, muss der Schnitt an den angezeigten Maßen am ausgewählten Punkt erfolgen, um die Anlage dort anzubringen. **Diese Tätigkeit wird immer mit Genehmigung des Kunden durchgeführt.**

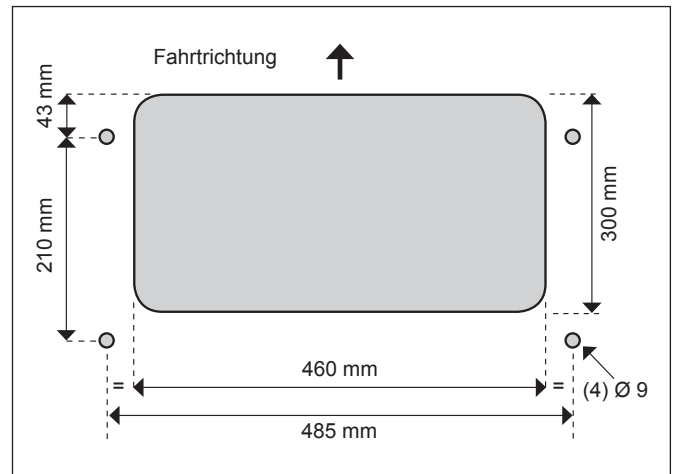

 Wenn am Fahrzeugblech Schnitte oder Bohrungen gemacht werden, ist es ratsam, diese mit einer Rostschutzfarbe gegen Korrosion zu schützen.

 Vor Montagebeginn vorderes Lufteintrittsgitter montieren.



**FAHRZEUGE MIT ORIGINALLUKE**

**1** Lukendeckel und dessen Befestigungselemente ausbauen und diese dem Kunden aushändigen.



**2** Vor dem Ankleben der EPDM-Dichtung die an Dach klebenden Reste entfernen.

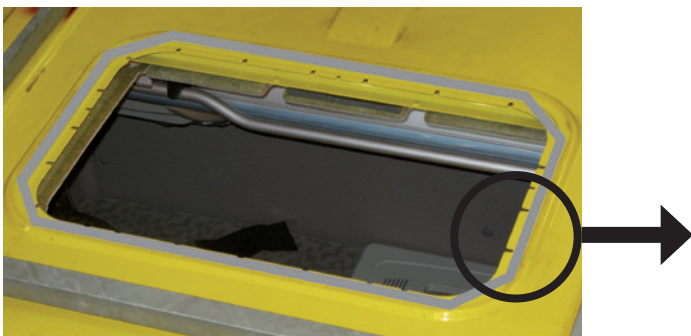



**3** Bei einigen Modellen lässt der Bezug keinen Platz für das Hineinstecken der Befestigungshalterungen. In diesem Fall sind die im Foto gezeigten Schnitte mit den angegebenen Maßen durchzuführen.

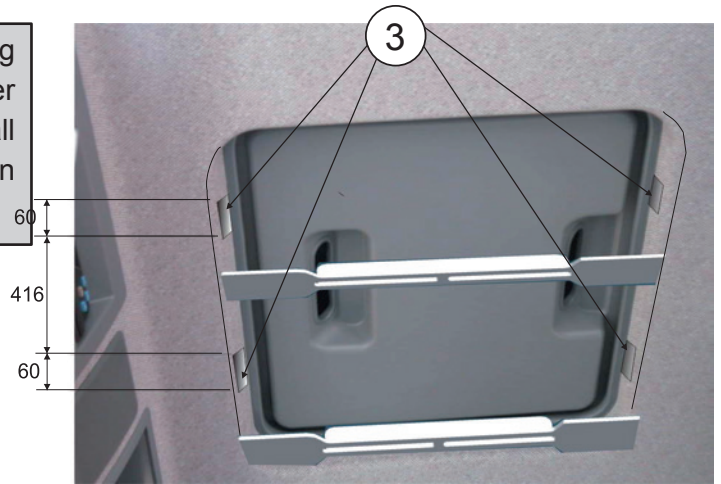

**4** Hat das Fahrzeug einen Spoiler mit Mittelstange, diese für die Installation des Geräts an den angegebenen Punktlinien aufschneiden. Diese Tätigkeit wird immer mit Genehmigung des Kunden durchgeführt.



**ALLE MODELLE**

**4a** Die EPDM-Dichtung um die Lukenöffnung oder der ausgeschnittenen Stelle herum kleben (siehe Detailzeichnung für das Zurechtschneiden der äußeren Verbindungsränder).  
**Achtung:** An dem mit Bohrungen ausgeschnittenen Stelle die Dichtung an den Bohrungen herum kleben.

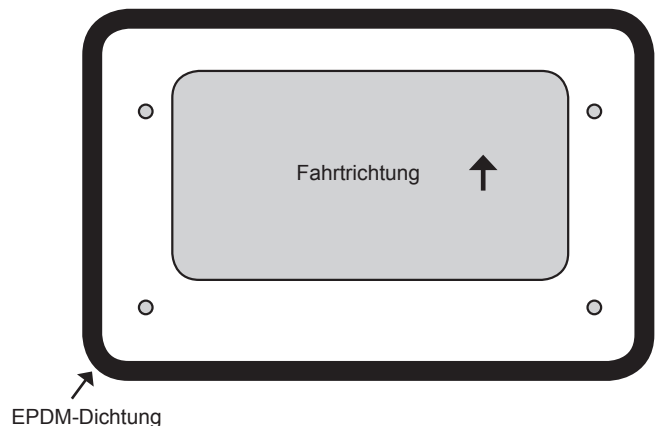
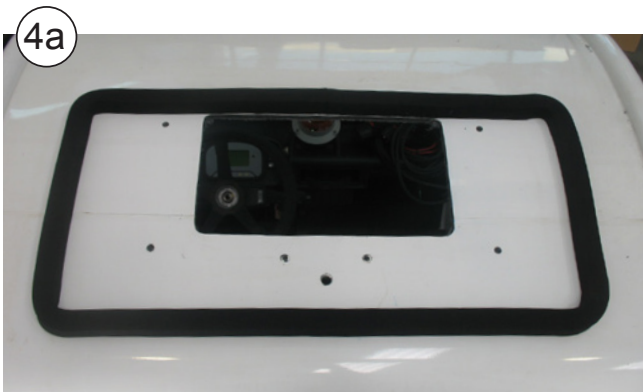
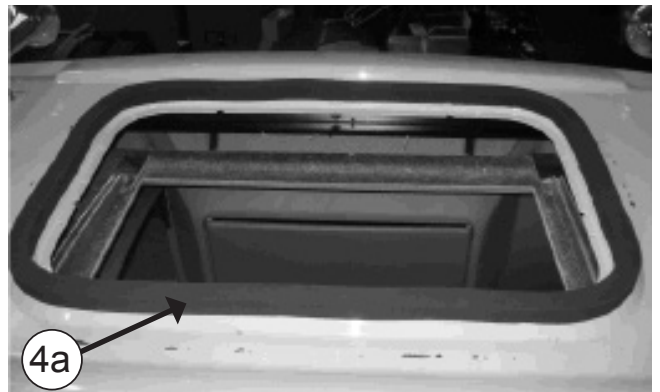



**WIE DIE EPDM-DICHTUNG GESCHNITTEN WIRD, UM FILTRATIONEN IN DER KABINE ZU VERMEIDEN**

- A- Dichtung aufkleben und dabei einen Papierschutz von 100 mm auf jeder Seite beibehalten.
- B- Die zwei Papierstücke entfernen.
- C- Unter Anpressen beider Enden aufkleben.

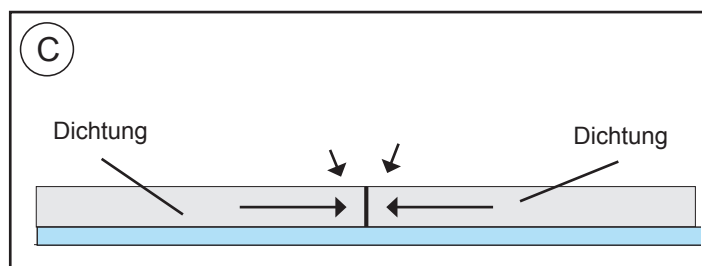
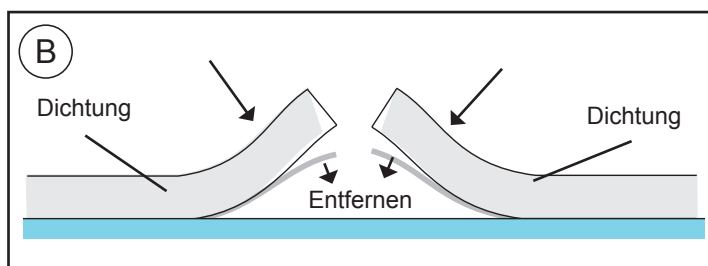
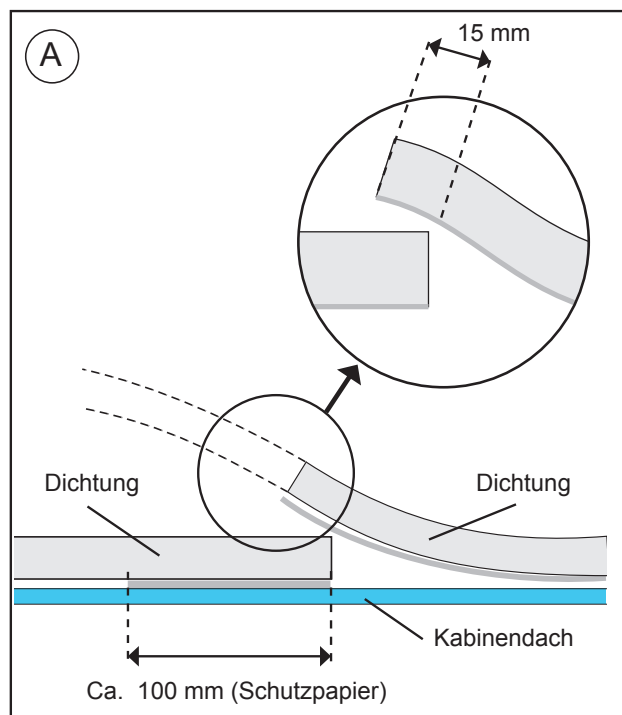

**FAHRZEUG MIT ORIGINALLUKE ODER VORMARKIERUNG AM DACH ZUM ANBRINGEN DER LUKE**

**5**

**KABINENAUSSENSEITE:**

Compact in der Lukenaussparung positionieren.

**Achtung!** Beim Auflegen des Geräts auf die Lukenaussparung darauf achten, dass die Ablassausgänge nicht von der EPDM-Dichtung zusammengedrückt werden.

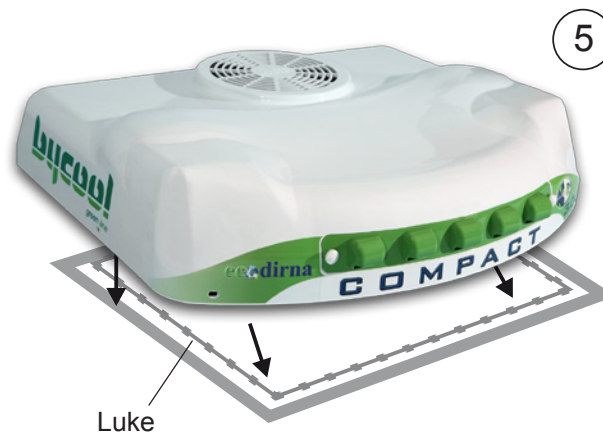

**6** An jeder Stiftschraube (1) Gummiunterlegscheibe Ø 7, (1) Breitflansch-Flachscheibe Ø 8, (2) Muttern M8 und (1) Breitflansch-Flachscheibe Ø 8 in der angegebenen Reihenfolge anbringen.

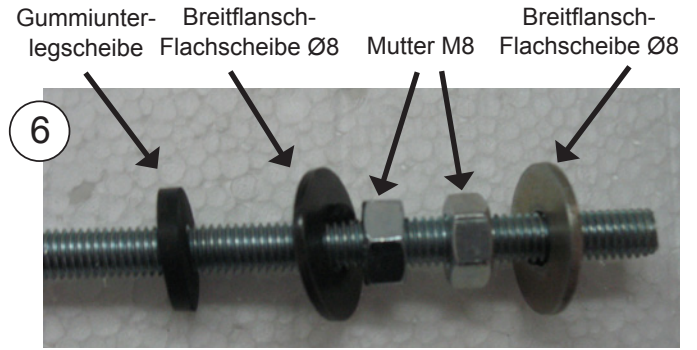

**7 KABINENINNENSEITE:**  
Stiftschrauben 8/125x100 bzw. 120 ca. 5 mm eindrehen. Das Maß wird gewählt, nachdem die Befestigungshalterungen angebracht wurden und unter Berücksichtigung, dass die Stiftschrauben aus diesen an der Unterseite ca. 20 mm herausstehen müssen.

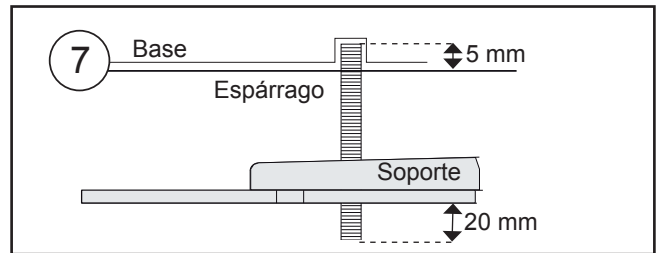

**8** 8. (2) Befestigungshalterungen mit (1) Unterlegscheibe und (1) selbstsichernder Mutter M8 anbringen, **ohne diese festzuziehen.**

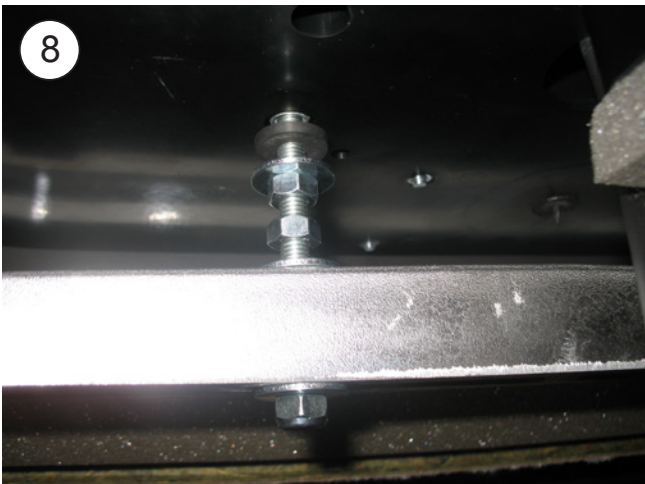
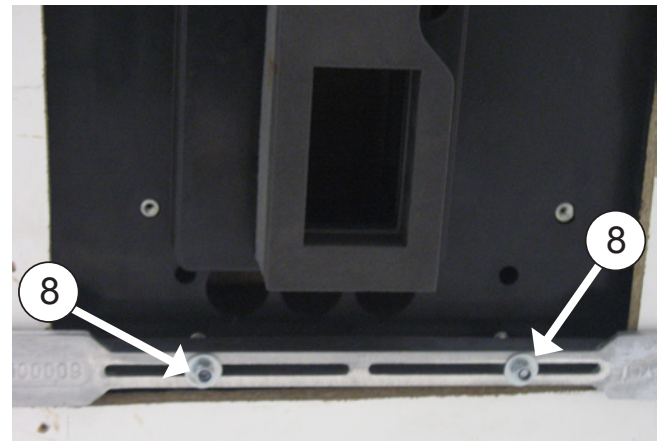

**FAHRZEUG OHNE ORIGINALLUKE UND OHNE VORMARKIERUNG AM DACH ZUM ANBRINGEN DER LUKE**

**5**

(1) Gummiunterlegscheibe  $\varnothing$  7, (2) Breitflansch-Flachscheibe  $\varnothing$  8 und (2) Mutter M8 an (4) die kürzesten Stiftschrauben M8 schräg anbringen.

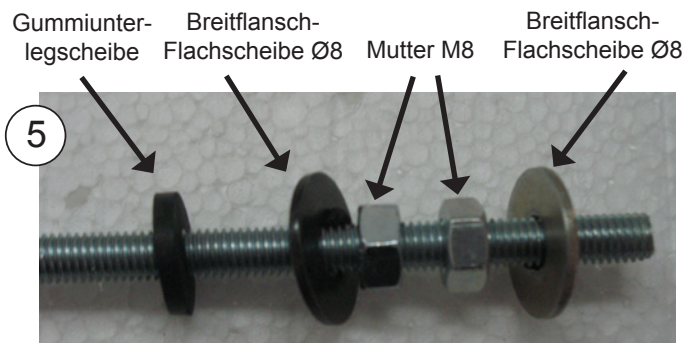

**6**

Die Stiftschrauben 15 mm in die Einsätze M8 der Grundplatte drehen und die Muttern gegen die Einsätze anziehen.

**Achtung:** Die Gummiunterlegscheibe liegt gegen die Gerätegrundplatte an.



**7**

Compact auf die ausgeschnittene Stelle positionieren. Die Stiftschrauben in die mit dem Schnitt gleichzeitig erfolgten Bohrungen  $\varnothing$  9 (\*) einführen.

**Achtung:** überprüfen, dass die Entwässerungsausgänge außerhalb der EPDM-Dichtung liegen und nicht von dieser zusammengedrückt werden.

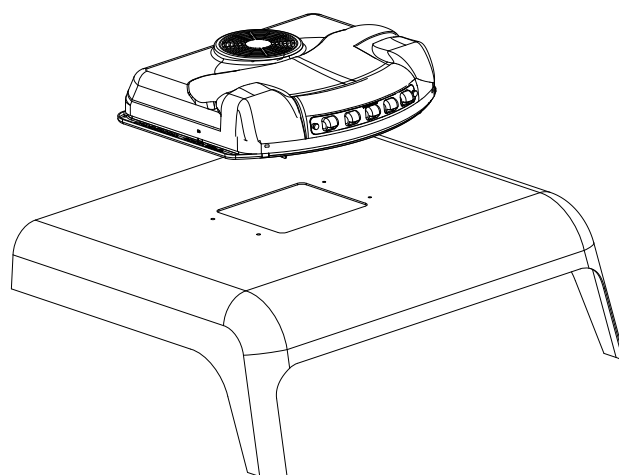



8

(1) Breitflansch-Flachscheibe  $\varnothing$  und (1) selbstsichernde Mutter M8/125 anbringen und anziehen bis die EPDM-Dichtung zwischen 3 und 6 mm zusammengedrückt wird. Danach die Mutter über das Kabinendach gegen diese anziehen.

**Die Dichtigkeit der EPDM-Dichtung zwischen der Gerätegrundplatte und Kabinendach überprüfen!**

**Wenn das Kabinendach verstärkt werden muss, an der Unterseite vom Kabinendach eine Halterung anbringen und mit den Unterscheiben  $\varnothing 8$  und selbstsichernden Muttern M8/125 befestigen!**



Verstärkungshalterung

**ALLE MODELLE**

9

Schaumgummidurchführung anbringen, wobei der weichere Teil auf der Gerätegrundplatte aufliegt.

**Achtung:** Je nach Kabine kann es notwendig sein die gelieferten (2) Kabelführungen zu verwenden, damit die Luftverteiltertafel an denselbigen komplett anliegt.





10

(4) Stiftschrauben M6 x 55 oder 80 an den angegebenen Stellen je nach Abstand (D) des Schemas in Punkt 16 10 mm eindrehen.

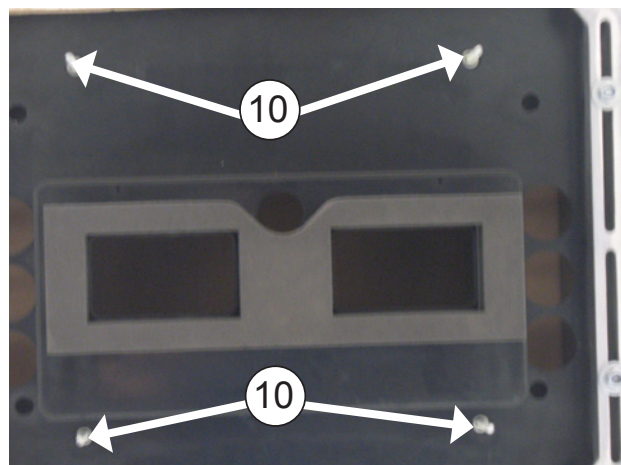

11

(1) Gummiunterlegscheibe  $\varnothing 6$ , (1) Breitflansch-Flachscheibe  $\varnothing 6$  und (1) Mutter M6 auf jeden Stiftschraube M6 legen. **Mutter anziehen**, danach Mutter anziehen, bis die Gummiunterlegscheibe ein wenig zusammengedrückt wird.

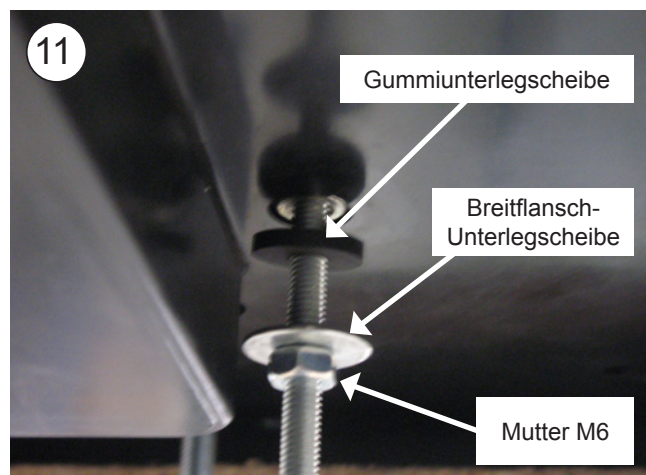

12

(1) Mutter M6 ohne Anziehen auf jede Stiftschraube legen.

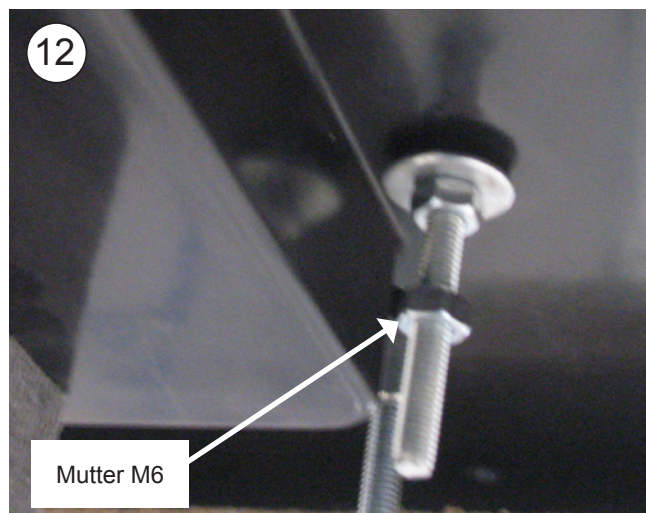

13

Zwischen der Grundplatte und der inneren Luftverteiltertafel (2) 2-Wege-Kästen des Frostschutzhühlers (weiße Kabeln) und Abluftsensur (schwarze Kabeln), 4-Wege-Kasten des Gebläses, (2) Kommunikatonskabeln und 8-Wege-Kasten der Verkabelung an den Anschluss mit der Elektroniksteuerung anschließen.

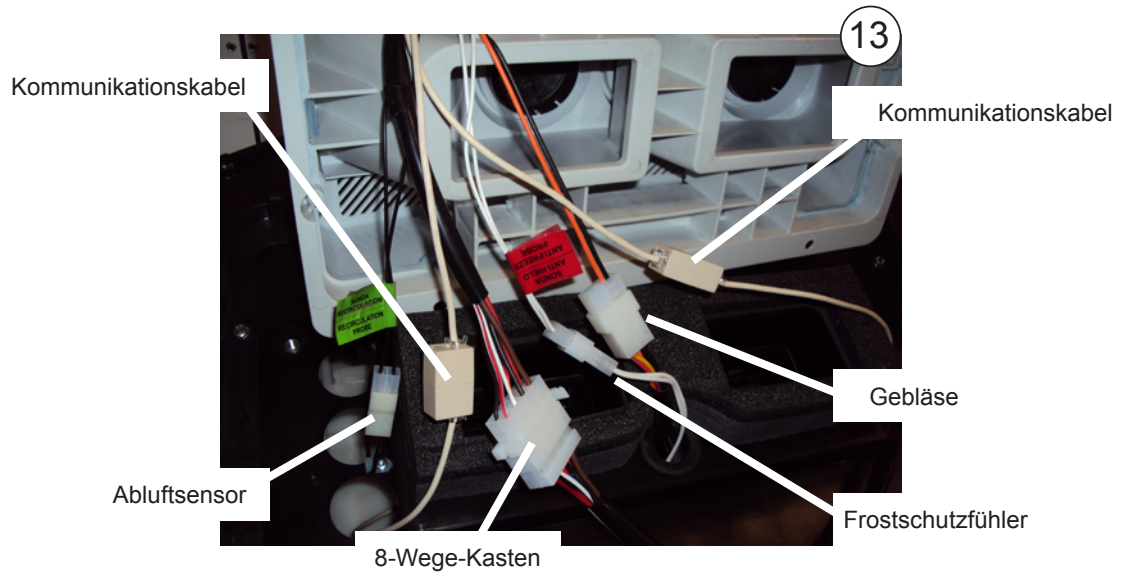

14

Innere Luftverteiltertafel an den vorgenannten Stiftschrauben mit jeweils (1) Breitflansch-Unterlegscheibe M6 und (1) Mutter M6 anbringen. Muttern anziehen, bis die Führung der inneren Luftverteiltertafel am oberen Schaumstoff der Anlage anliegt.

**Wichtig:** Die Führung der inneren Luftverteiltertafel muss an den oberen Schaumstoff des Gerätes stoßen, um das Entweichen von Luft zu vermeiden.

Darauf achten, dass die Kabel nicht zwischen der Kabelführung und dem Schaumstoff an der Grundplatte der Anlage gequetscht werden.

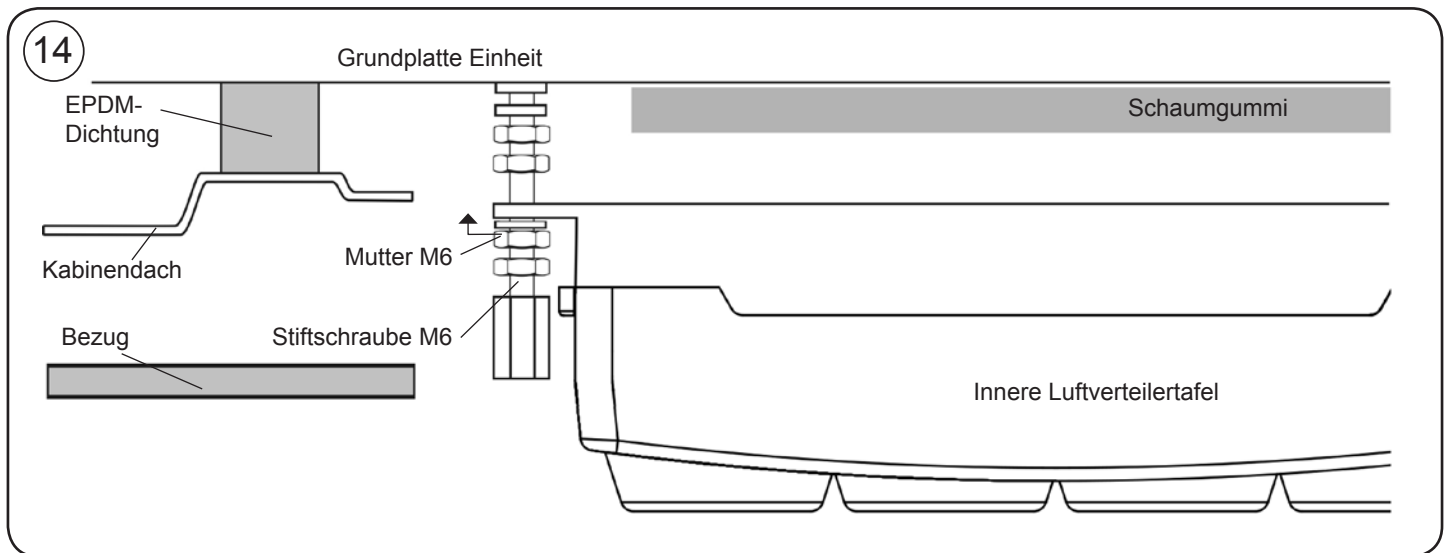

15

Mutter aus Punkt 12 anziehen, bis diese an das Oberteil der inneren Luftverteiltertafel stößt.

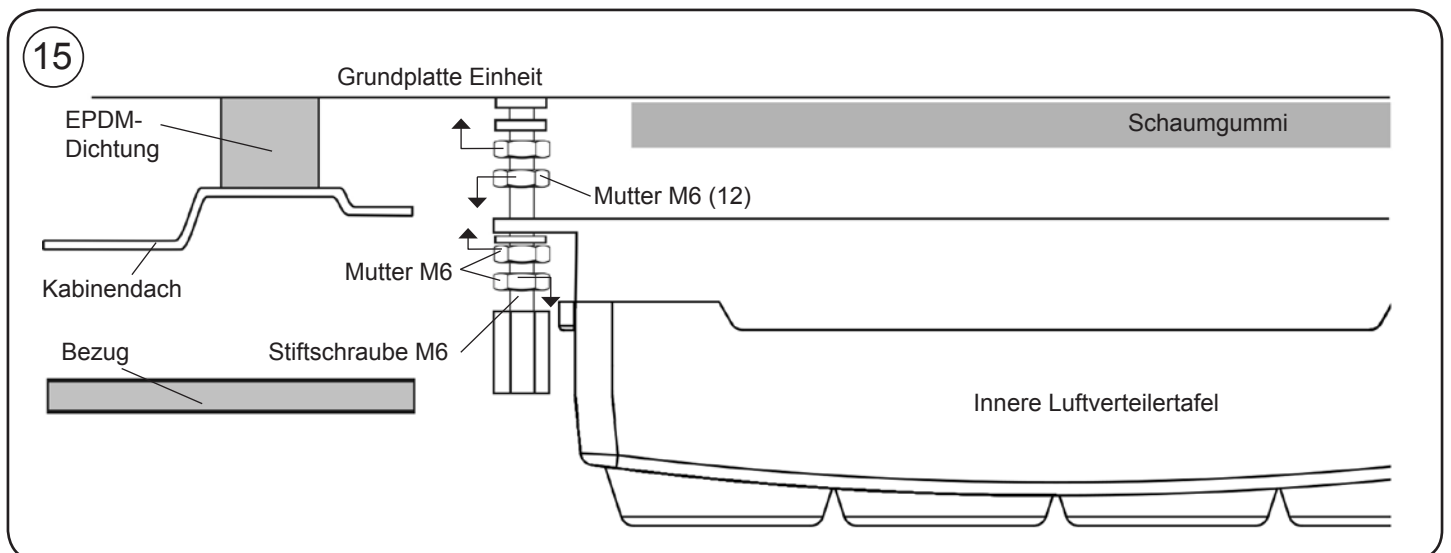

**FAHRZEUG MIT ORIGINALLUKE ODER VORMARKIERUNG AM DACH ZUM ANBRINGEN DER LUKE**

**15a** Konsole nehmen und die Anlage an der geeignetsten Stelle am Kabinendach zentrieren. Nach dem Zentrieren Konsole entfernen.

**15b** Befestigungshalterungen durch Anziehen der Muttern so befestigen, dass die äußere EPDM-Dichtung des Geräts zwischen 3 und 6 mm zusammengedrückt wird.

**Wichtig:** Um das eventuelle Eindringen von Wasser in die Kabine zu vermeiden, muss sichergestellt sein, dass die EPDM-Dichtung an der Grundplatte des Compact so festgezogen ist, wie im **Schema** angegeben.



Die Komprimierung der EPDM-Dichtung an allen vier Ecken mit einem Bandmaß prüfen.

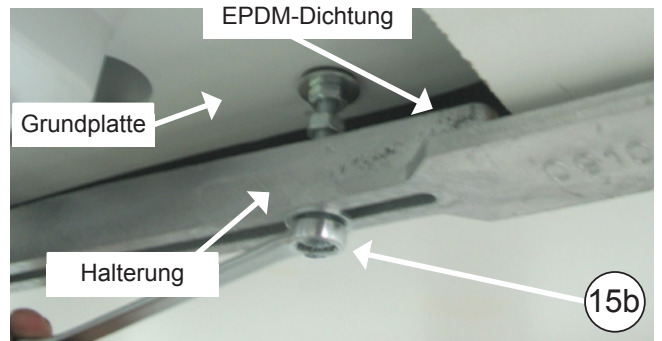
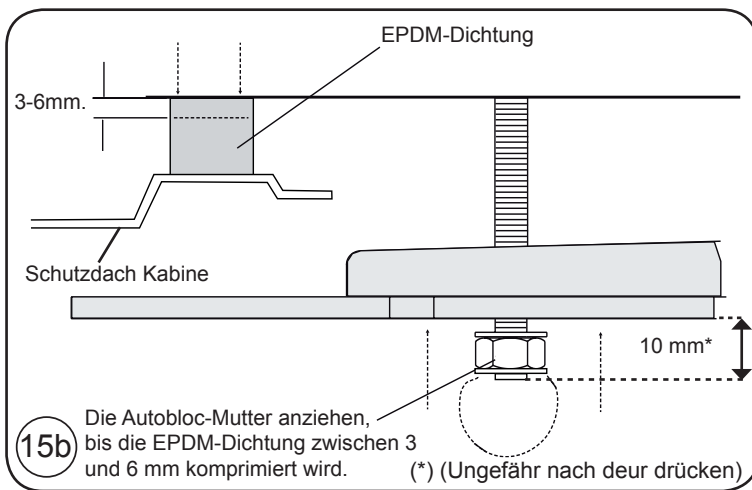

**15c** (4) Muttern M8 an der Halterung und (4) an der Grundplatte des Compact anziehen.

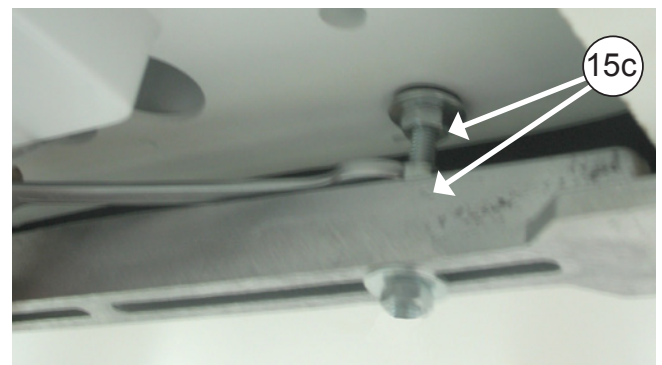



ALLE MODELLE

16

Eine Mutter M6 (A) hinter der Befestigungsmutter der inneren Luftverteiltertafel an allen Stiftschrauben anbringen. Sechskant-Verbindungs-muttern M6 eindrehen, bis sie 1 mm über dem Bezug herausstehen. Muttern M6 (A) dieses Punkts herausschrauben, bis sie an die Sechskant-Verbindungs-muttern anstoßen, und gegen diese anziehen.

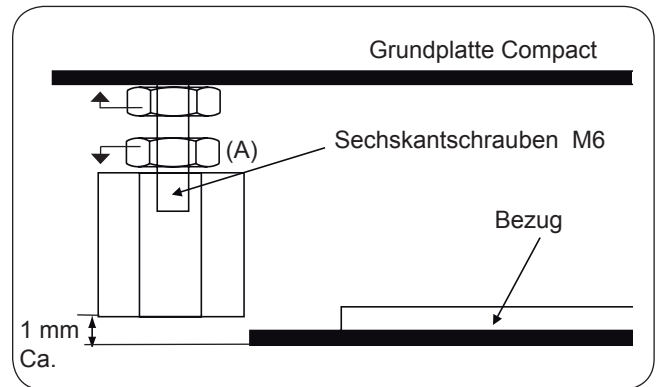

16

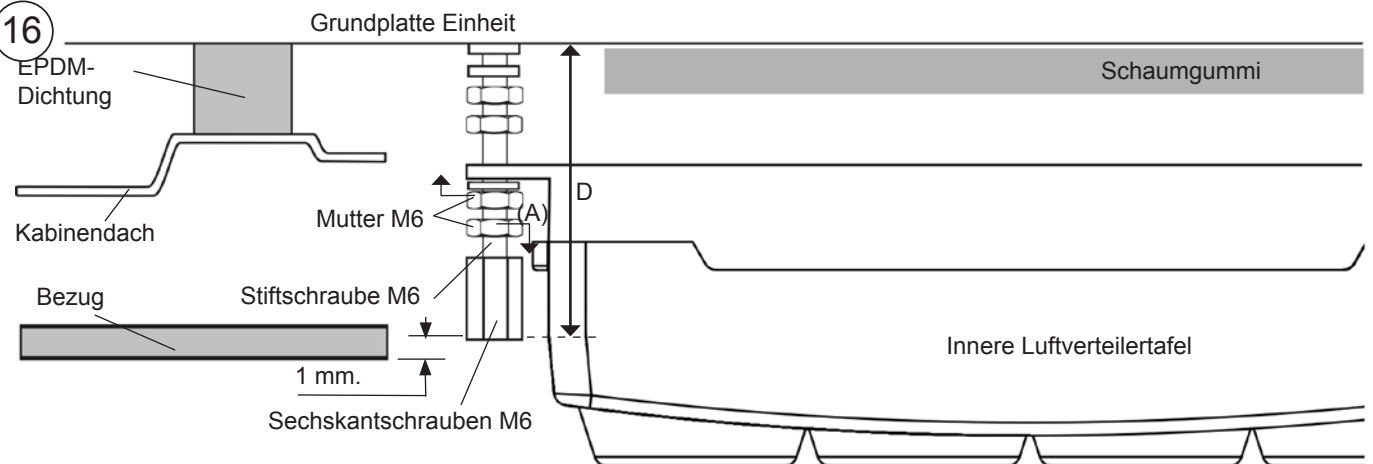

17

Konsole mit (4) Innensechskantschrauben M6/100x15 anbringen.

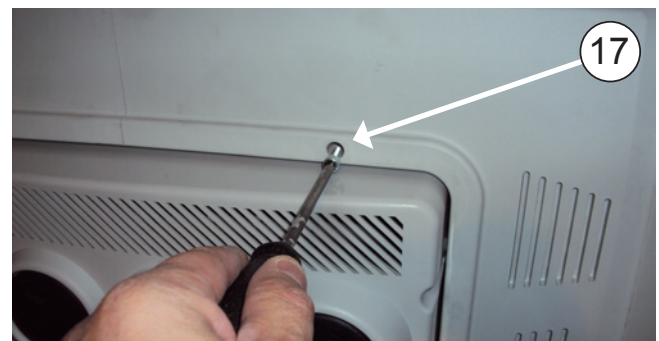

18

Die (4) Innensechskantschrauben M6/100x15 mit den runden Kunststoff-Zierstopfen M6 abdecken.





**FAHRZEUG OHNE ORIGINALLUKE UND OHNE VORMARKIERUNG AM DACH ZUM ANBRINGEN DER LUKE**

**Explosionsansicht bis zur Befestigung der Halterungen**

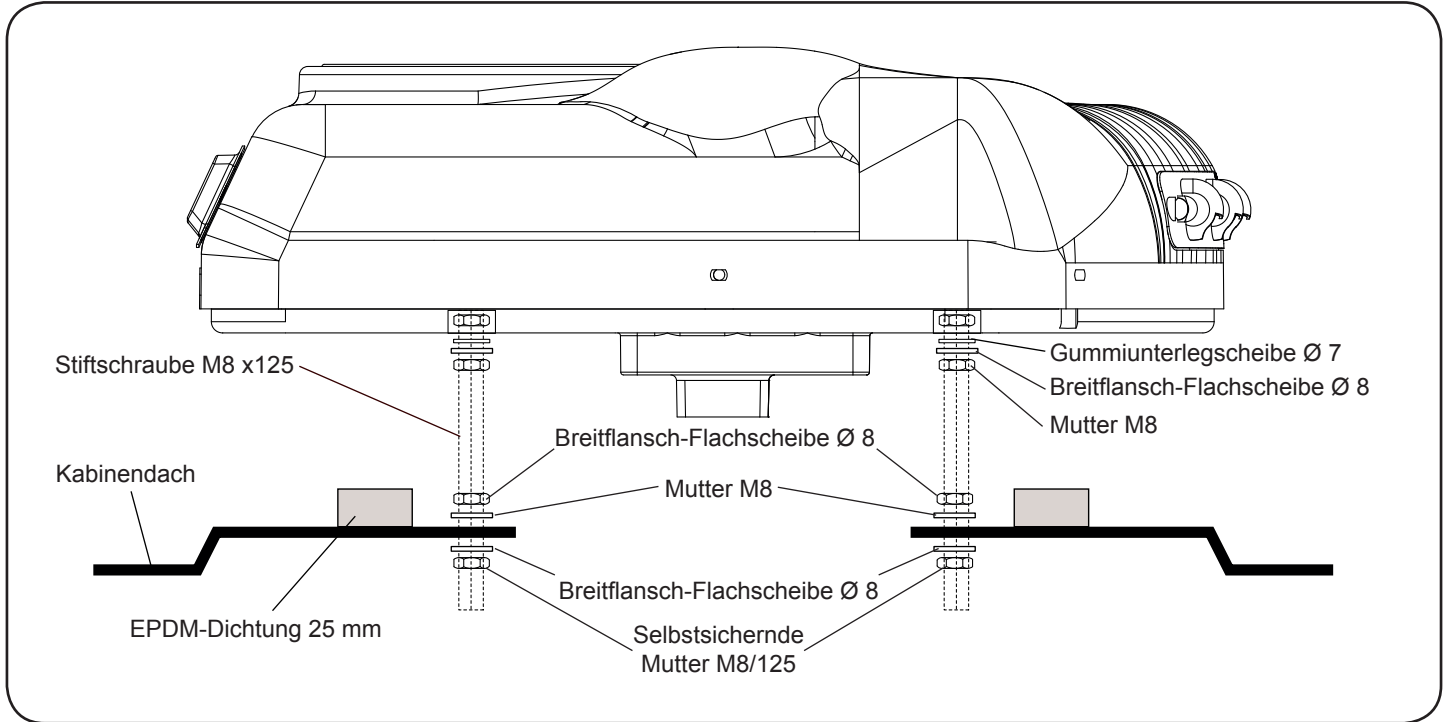

**Explosionsansicht bis zur Befestigung der Konsolen**

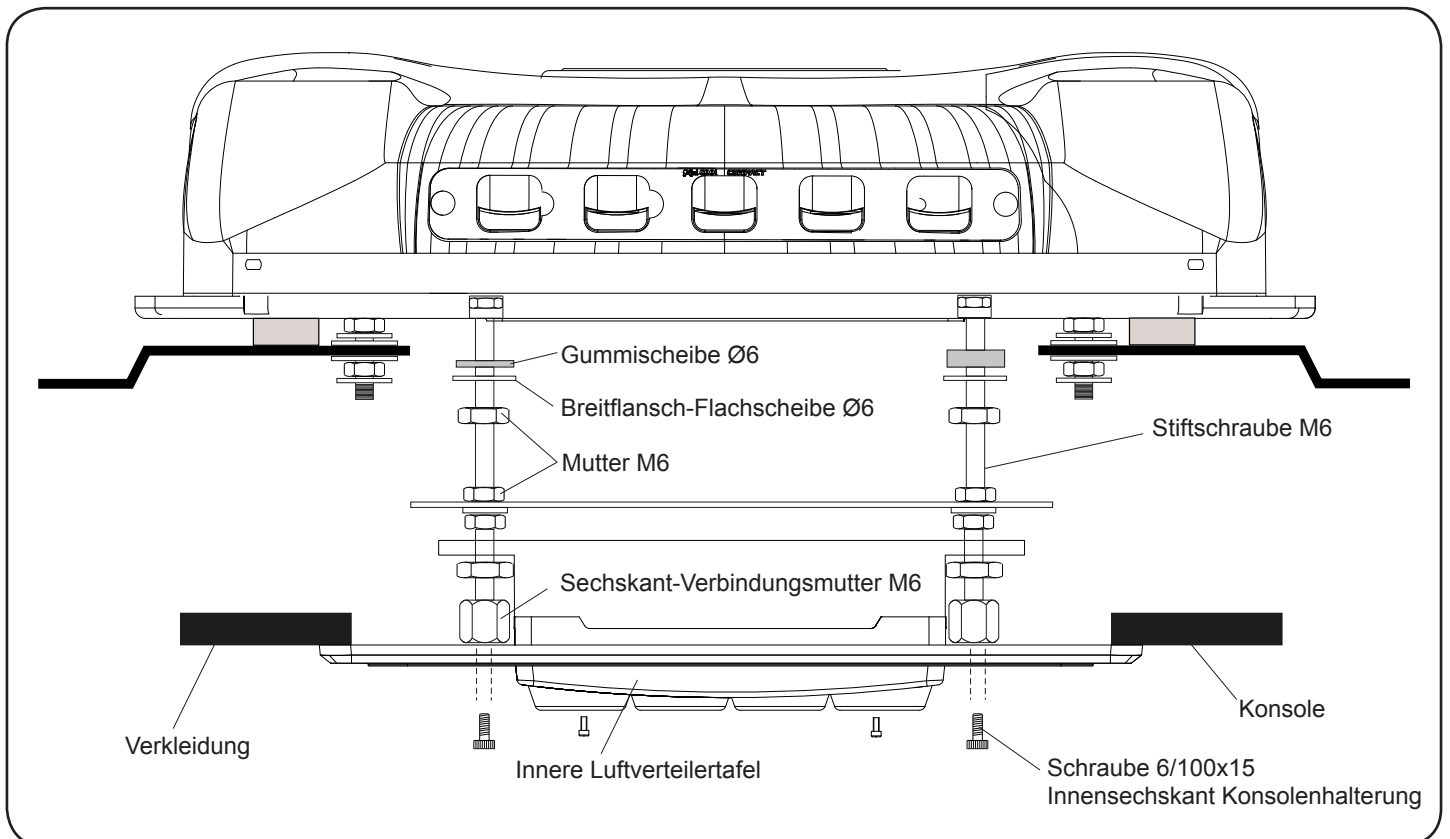

**FAHRZEUG MIT ORIGINALLUKE ODER VORMARKIERUNG AM DACH ZUM ANBRINGEN DER LUKE**

**Explosionsansicht bis zur Befestigung der Halterungen**

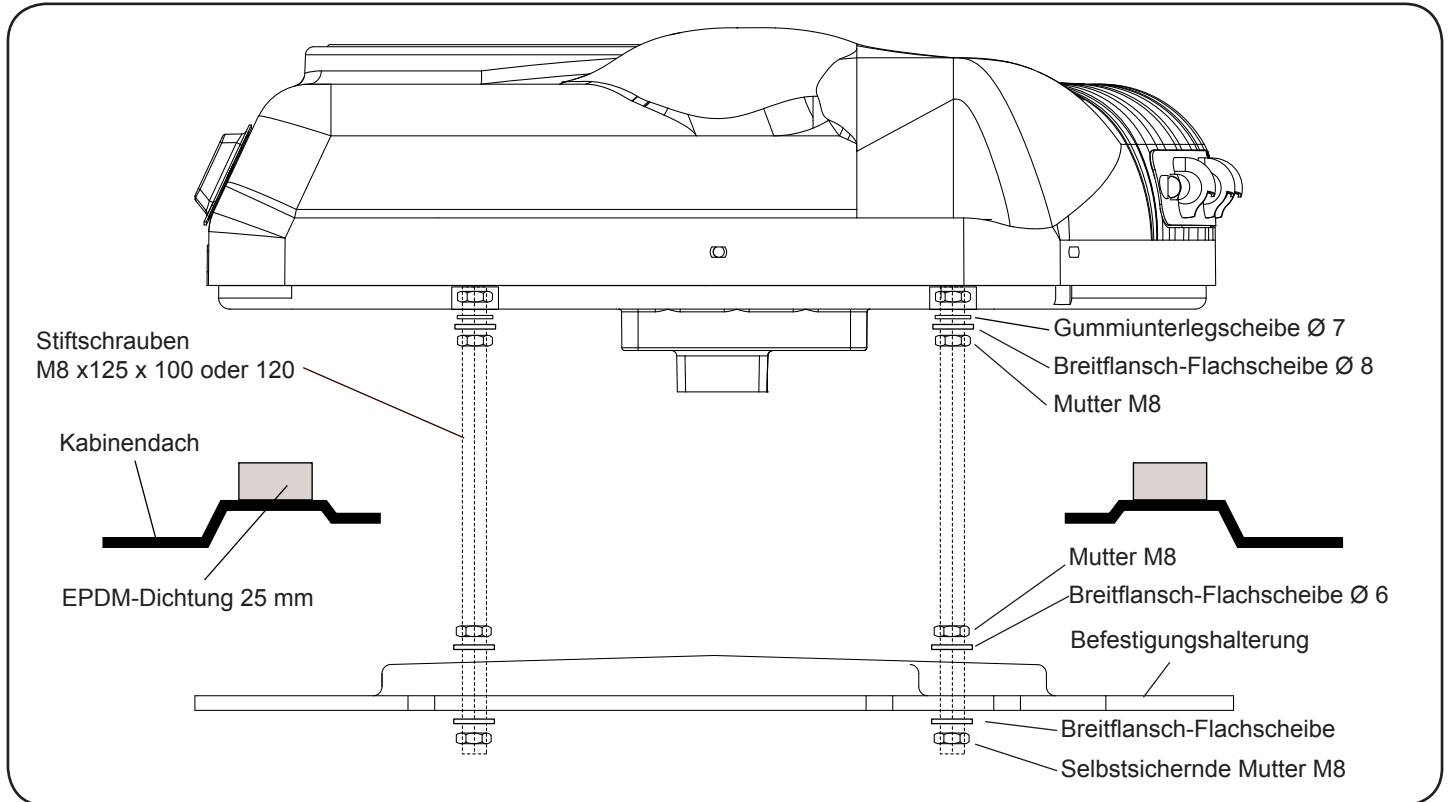

**Explosionsansicht bis zur Befestigung der Konsolen**

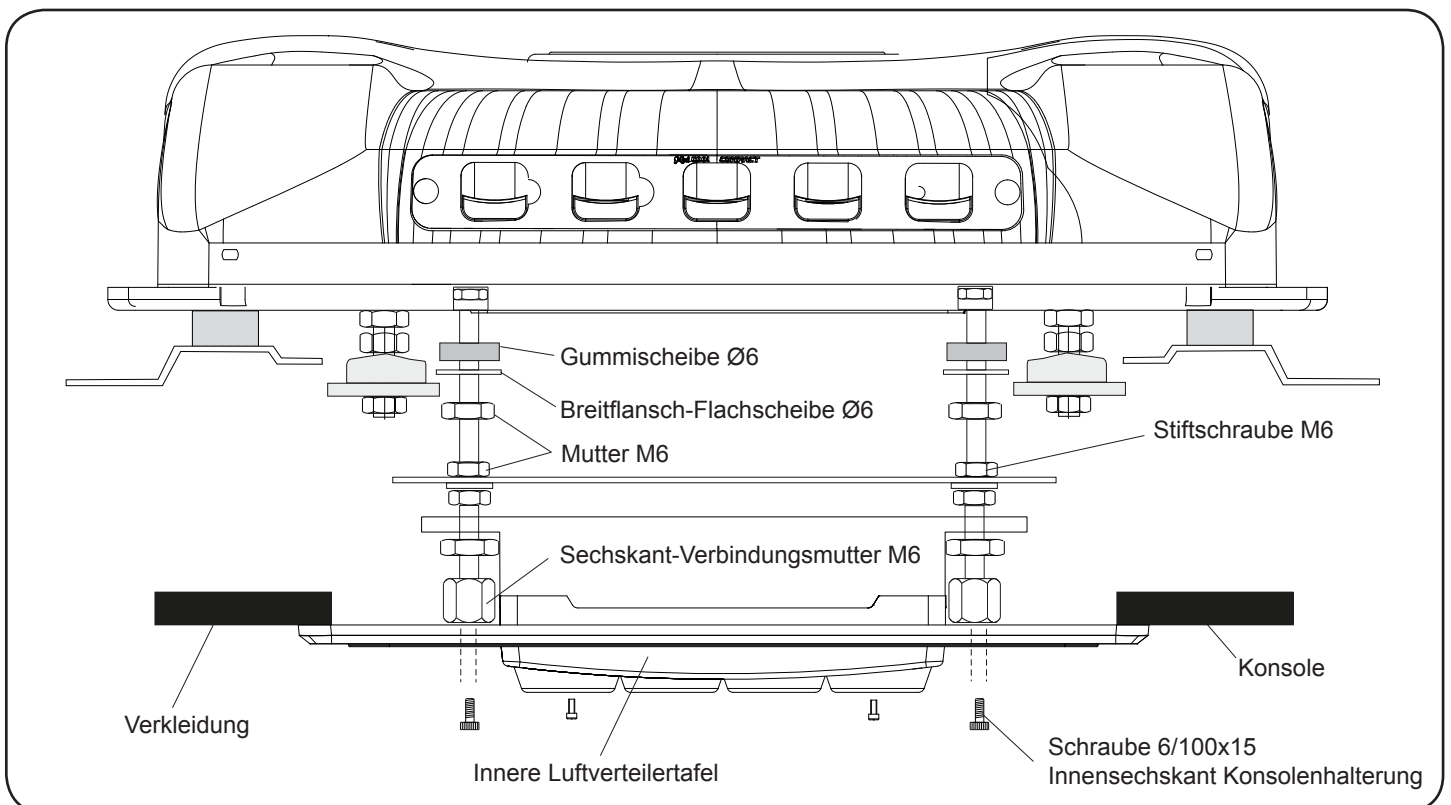

## Detaillierte Anleitung für die Installation der Netzkabel

**1** Das obere Netzkabel an der Gerätehinterrseite anschließen und an der Kabinenrückseite unter Ankleben der Kunststoffhalterungen und Befestigung durch Kabelbinder entlang führen.

**2** Das untere Netzkabel an der Batterie anschließen, entlang der Original-Kabelführung führen, mit Kabelbindern befestigen, zur Kabinenhinterseite führen und dort an das obere Netzkabel anschließen.

 **Beim Anschluss der Kabel genügend Abstand lassen, um Bruch aufgrund der Kabinenbewegung zu vermeiden!**

**Wichtig:** Aufgrund der komplizierten elektronischen Steuerung des Geräts muss die Stromversorgung direkt an der Fahrzeugbatterie erfolgen.

**Wichtig:** Für die Inbetriebnahme bitte im **Benutzerhandbuch** nachschlagen.

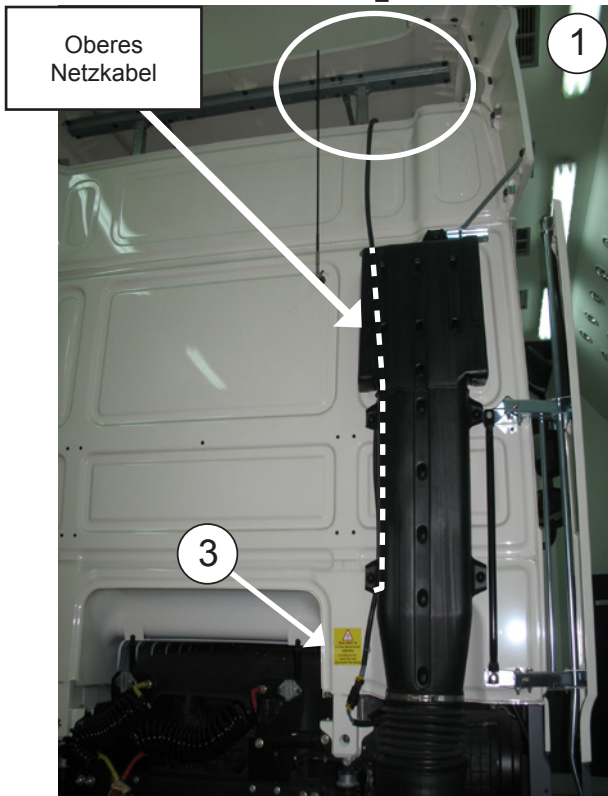
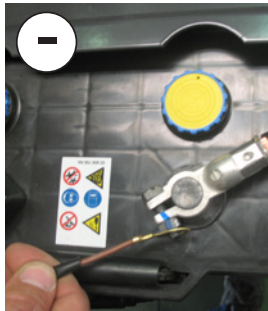
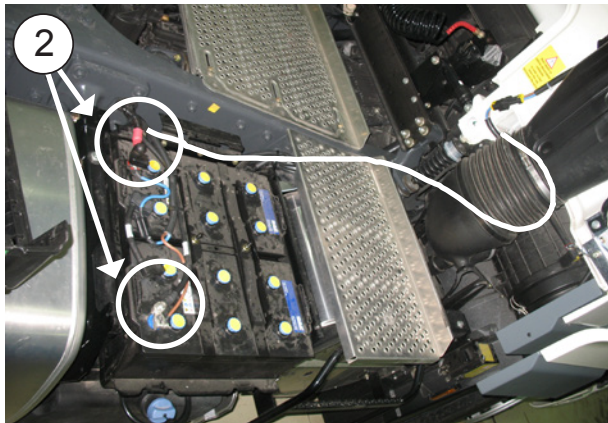

**3** Gefahrenhinweise an Kabelverbindung und Kabinenhebevorrichtung anbringen.



# Elektrische Verkabelung

## WICHTIGER WARHNHWEIS!

**Darauf achten**, dass die Polaritäten beim Anschluss der Stromversorgung an das Gerät nicht vertauscht werden. Ist dies der Fall, schaltet sich die Elektroniktafel nicht ein, das Gerät funktioniert nicht und es kommt zu irreparablen Schäden an den Kompressormodulen.

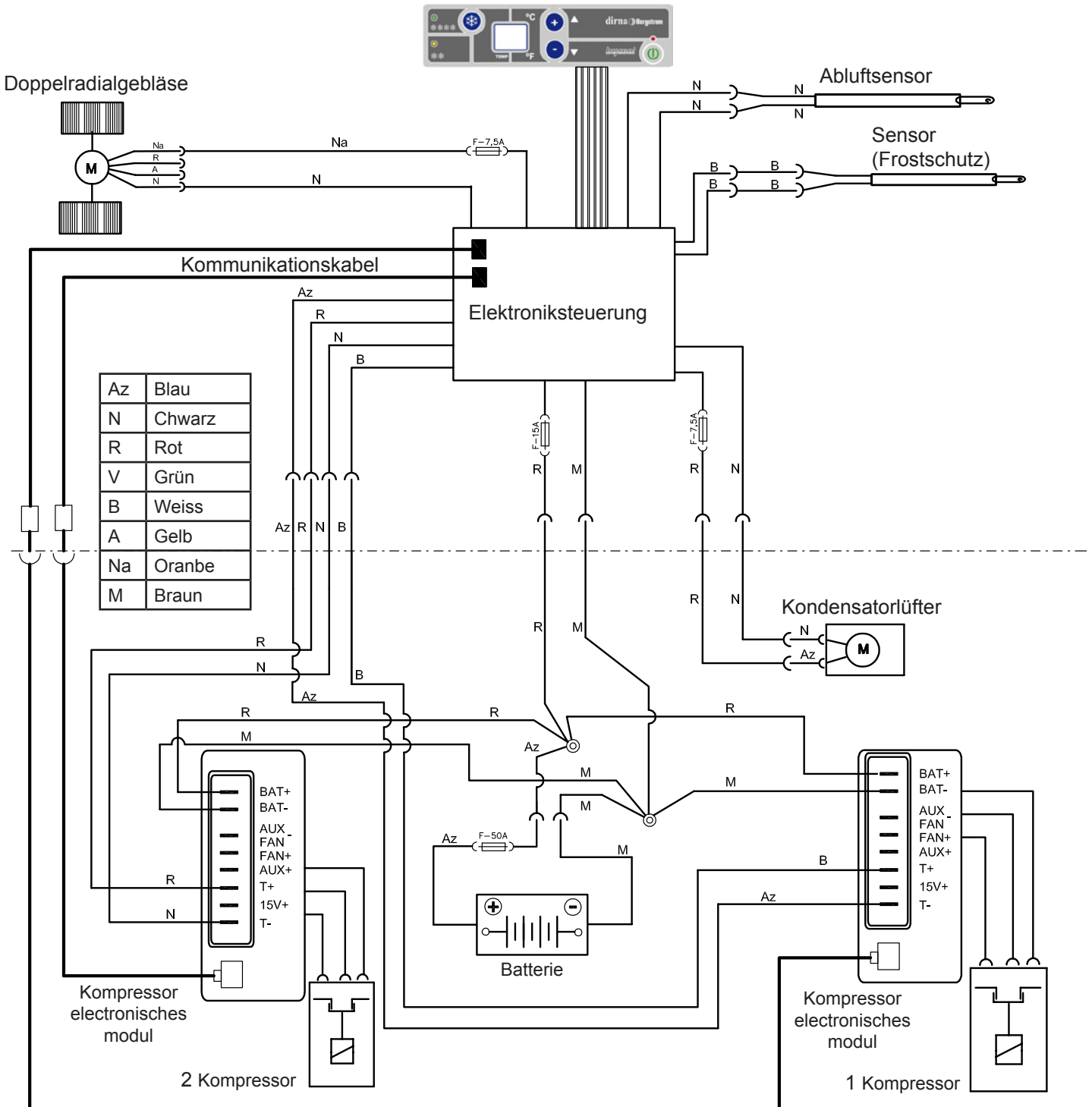





## Suggerimenti per il montaggio

- Prima di cominciare il montaggio, leggere attentamente le istruzioni e rispettarle nel corso dello stesso.
- Usare gli attrezzi più adatti ad ogni operazione.

## Elettricità

- Scollegare la chiave di contatto.
- Scollegare la batteria prima di cominciare il montaggio.
- Assicurarsi di aver effettuato correttamente l'installazione e il collegamento dei componenti elettrici.

## Attenzione

Se durante il montaggio si inclina l'impianto, prima di rimetterlo in funzione occorre attendere almeno 60 minuti dal momento in cui è di nuovo in posizione orizzontale.

## Attenzione

Quando si installa l'impianto di aria condizionata sul tettuccio, bisogna proteggere la parte superiore della cabina con uno straccio o una coperta per evitare eventuali graffi. Per l'installazione del **Compact**, tenere presente che normalmente le cabine munite di oblò dispongono di una struttura abbastanza solida per sostenere il peso dell'impianto. Tuttavia, se così non fosse e se fosse necessario tagliare il tettuccio, o se in presenza di oblò la struttura non fosse abbastanza rigida (se fosse di fibra, plastica, ecc.), è responsabilità dell'installatore decidere se occorre rinforzare il tettuccio per evitare qualsiasi deformazione, rottura o penetrazione d'acqua, ecc., prendendo le misure necessarie per evitarlo.

## Attrezzi

Kit di chiavi Torx  
 Kit di chiavi Allen  
 Chiave fissa 10, 13, 14  
 Forbici  
 Metro a nastro

## Documentazione allegata

Istruzioni di montaggio	1001217242
Guida dell'utente	1001218019
Soluzione dei problemi	1001218025
Garanzia	220AA10017

## Simbologia



Fragile



Attenzione alle mani



Tensione elettrica pericolosa

## Avvertenze



L'installatore deve essere in possesso della formazione necessaria in materia di aria condizionata per veicoli.



**dirna Bergstrom, s.l.** declina ogni responsabilità per danni o rotture derivanti dall'errata installazione o dall'errato uso dell'impianto o da sostituzioni o modifiche effettuate senza la necessaria autorizzazione per iscritto.



**Impianto precaricato con gas refrigerante. (Non manomettere il circuito di gas refrigerante).**



Vedi la **procedura di garanzia** del prodotto in **Diagnosi dei problemi**.





Vedi la **Guida dell'utente** dell'impianto per il corretto funzionamento del telecomando e del pannello di controllo.





I seguenti documenti devono essere consegnati all'utente una volta conclusa l'installazione: **Guida dell'utente, Garanzia e Diagnosi dei problemi**.

 In genere il tettuccio delle cabine dispone di rinforzi sufficienti per sostenere il peso dell'impianto, altrimenti occorre irrobustire il tettuccio della cabina per evitarne la deformazione e renderlo in grado di sopportare il peso dell'impianto.

 Nei veicoli privi di tettuccio apribile, ma nei quali è segnato il perimetro per il montaggio, occorre tagliare il contorno premarcato, lasciando la distanza necessaria per il montaggio della guarnizione. **Questa operazione va sempre eseguita con l'autorizzazione del cliente.**

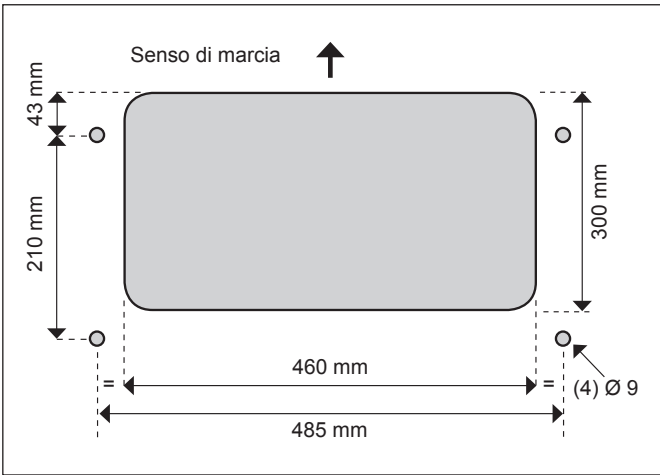
 Nei veicoli privi di tettuccio apribile e nei quali non è segnato il perimetro per il montaggio, occorre eseguire il taglio alle misure indicate, nel sito prescelto per montare l'impianto. **Questa operazione deve essere sempre eseguita con l'autorizzazione del cliente.**



 Se si praticano tagli o fori nella lamiera del veicolo, è consigliabile l'applicazione di antiruggine per evitarne la corrosione.

 Prima di cominciare il montaggio, montare la griglia sull'entrata dell'aria anteriore.



**VEICOLI CON TETTuccio APRIBILE ORIGINALE**

**1** Smontare il coperchio del tettuccio apribile e gli elementi di fissaggio e consegnarli al cliente.



**2** Rimuovere i residui eventualmente rimasti attaccati al tettuccio prima di incollare la guarnizione EPDM.

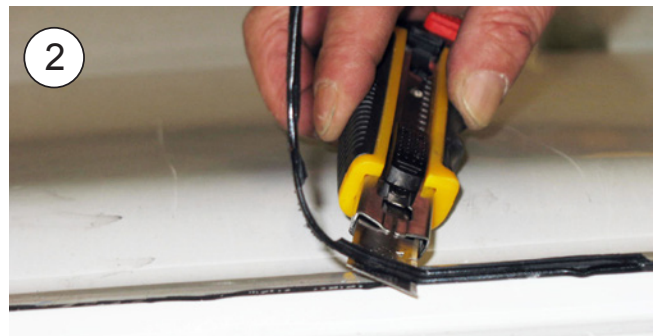
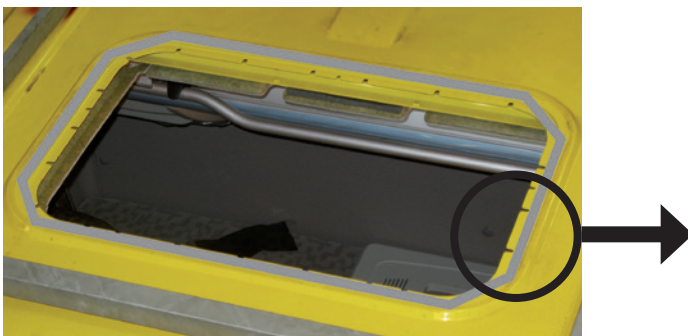

**3** In alcuni modelli, la tappezzeria non lascia spazio per inserire i supporti di fissaggio, perciò occorre eseguire i tagli con le misure indicate nella foto.

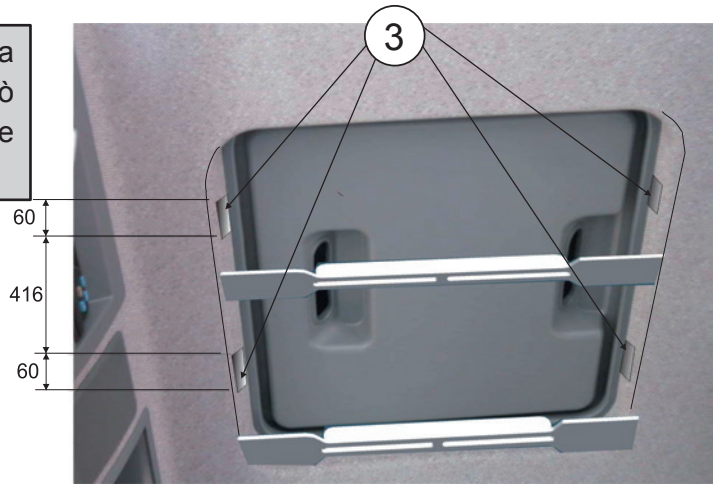

**4** Se il veicolo è munito di spoiler con barra centrale, per il montaggio dell'impianto tagliare la barra lungo le linee tratteggiate. Questa operazione va sempre eseguita con l'autorizzazione del cliente.

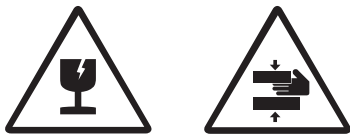

**TUTTI I MODELLI**

**4a** Incollare la guarnizione in EPDM intorno al vano del tettuccio apribile o del taglio eseguito (vedi il particolare per tagliare le estremità della guarnizione).  
**Attenzione:** nel taglio realizzato con i fori, incollare la guarnizione intorno ai fori.

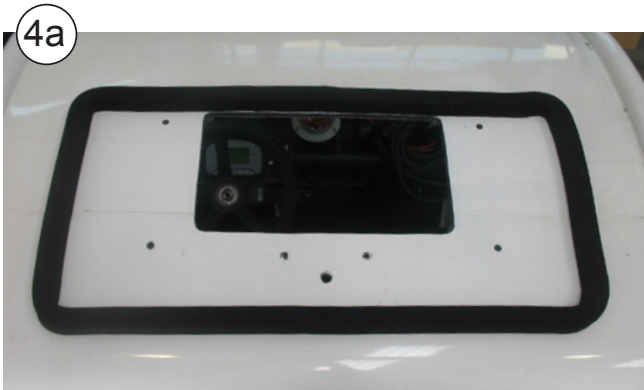
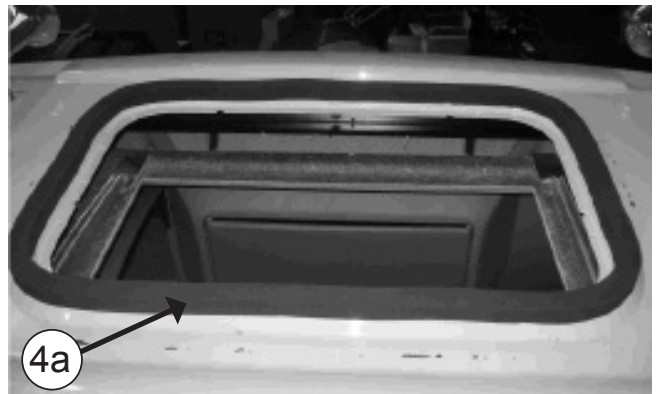

Guarnizione EPDM

 **COME TAGLIARE LA GUARNIZIONE EPDM PER EVITARE INFILTRAZIONI NELLA CABINA**

**A-** Incollare la guarnizione mantenendo una protezione di carta di 100 mm su ogni lato.

**B-** Rimuovere i due pezzi di carta.

**C-** Incollare premendo su entrambe le estremità.

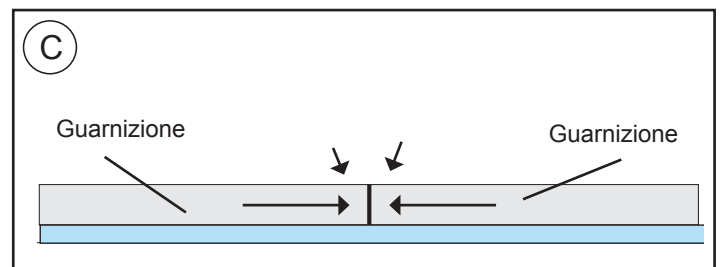
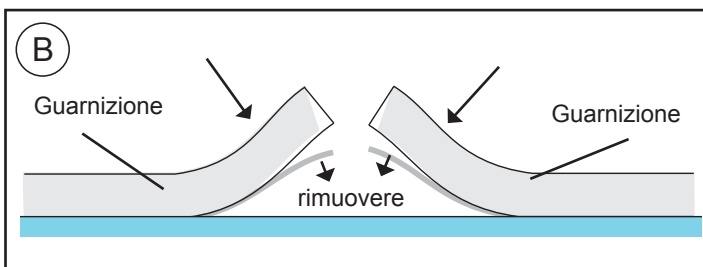
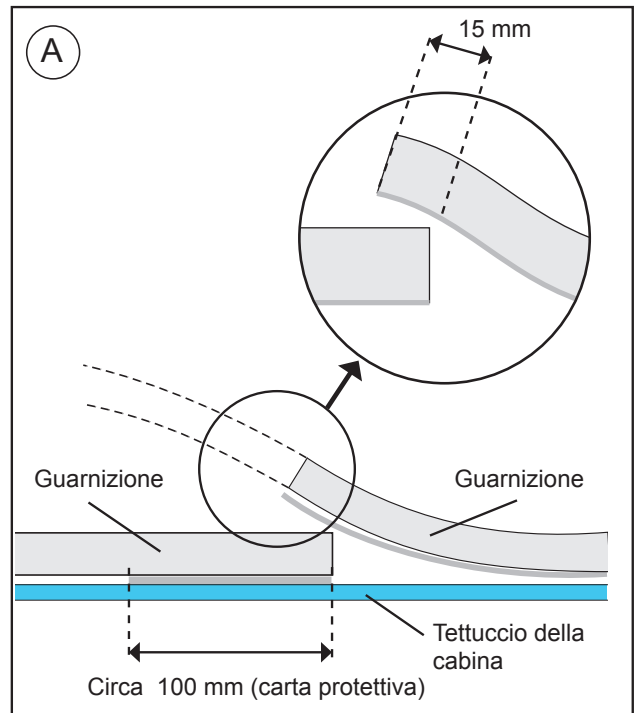

**VEICOLI CON TETTuccio APRIBILE ORIGINALE O PREMARCATO PER IL MONTAGGIO DELL'IMPIANTO**

**5** **ESTERNO CABINA:**

Inserire il Compact nel vano del tettuccio apribile.

**Attenzione!** Nel sistemare l'impianto nel vano del tettuccio apribile, controllare che le uscite di scarico non siano ostruite dalla guarnizione EPDM.





**6** Inserire (1) rondella Ø 7 di gomma, (1) rondella piana Ø 8 a testa larga, (2) dadi M8 e (1) rondella piana Ø 8 a testa larga, su ciascuna vite prigioniera precedente, seguendo quest'ordine.

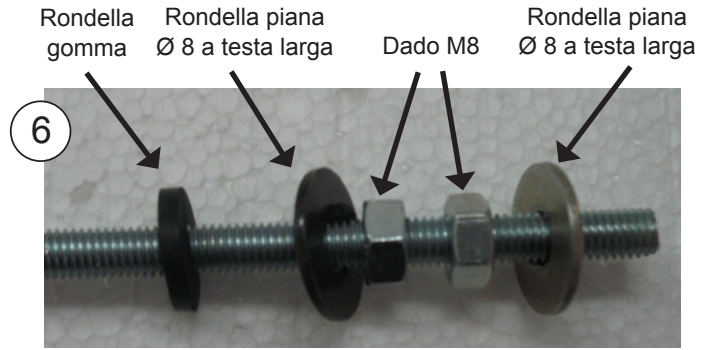

**7** **INTERNO CABINA:**  
Avvitare di circa 5 mm (4) viti prigioniera 8/125x100-70 o 120: la misura va selezionata una volta posizionati i supporti di fissaggio e tenendo conto che le viti prigioniera devono sporgere di circa 20 mm dalla parte inferiore degli stessi.

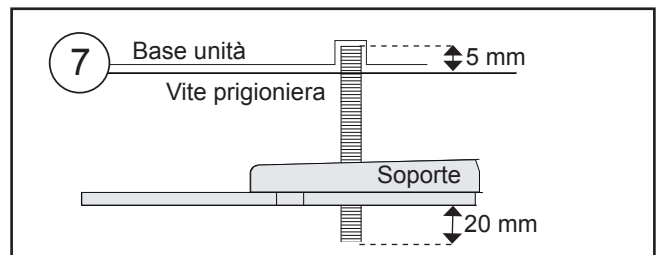

**8** Posizionare (2) supporti di fissaggio, con (1) rondella e (1) dado autobloccante M8, **senza stringere**.

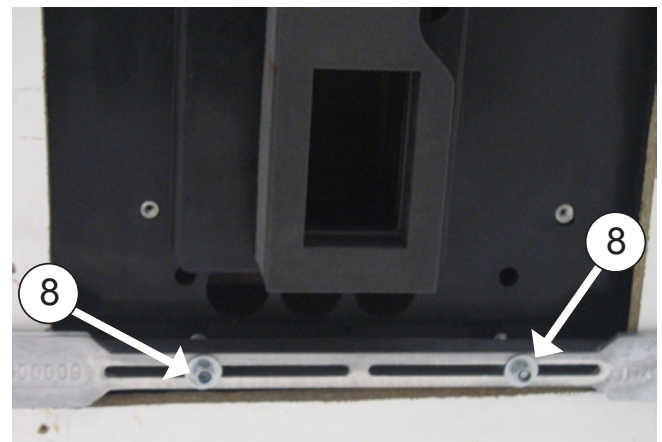
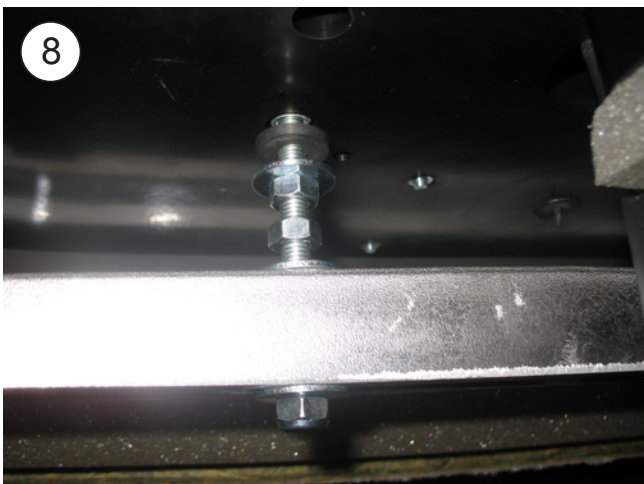

## VEICOLI SENZA TETTUCCIO APRIBILE ORIGINALE O PREMARCATO PER IL MONTAGGIO DELL'IMPIANTO

5

Inserire (1) rondella Ø 7 di gomma, (2) rondelle piane Ø 8 a testa larga e (2) dadi M8 su (4) viti prigioniere M8 più corte nella posizione indicata.

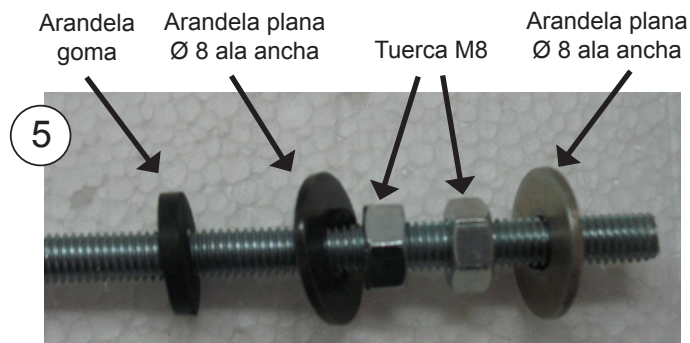

6

Avvitare le viti prigioniere di 15 mm negli inserti M8 della base e stringere i dadi su quest'ultima.

**Attenzione:** La rondella di gomma resta addossata alla base dell'impianto.



7

Inserire il Compact nel taglio eseguito e inserire le viti prigioniere nei fori Ø 9 (\*) praticati insieme al taglio.

**Attenzione:** accertarsi che le uscite di scarico non siano coperte né ostruite dalla guarnizione EPDM.

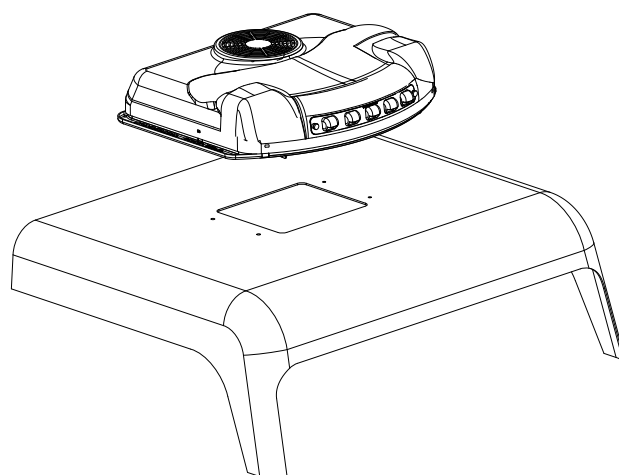

8

Inserire (1) rondella piana Ø 8 a testa larga e (1) dado M8/125 autobloccante e stringere fino a comprimere la guarnizione EPDM tra 3 e 6 mm, dopo aver stretto il dado presente al di sopra del tettuccio della cabina contro quest'ultimo.

**Verificare la tenuta della guarnizione EPDM tra la base dell'impianto e il tettuccio della cabina!**

**Se fosse necessario rinforzare il tettuccio della cabina inserendo il supporto incollato alla parte inferiore del tettuccio della cabina e fissandolo con le rondelle Ø 8 e dadi M8/125 autobloccanti!**



Supporto di rinforzo

## TUTTI I MODELLI

9

Montare il canalizzatore di gommapiuma con la parte più morbida sulla base dell'impianto.

**Attenzione:** a seconda della cabina, potrebbe essere necessario usare i (2) canalizzatori in dotazione per incastrarvi completamente il pannello di distribuzione dell'aria.





10

Avvitare di 10 mm (4) viti prigioniere M6 x 55 o 80, nei punti indicati, a seconda della distanza (D) dello schema del punto 16.6.

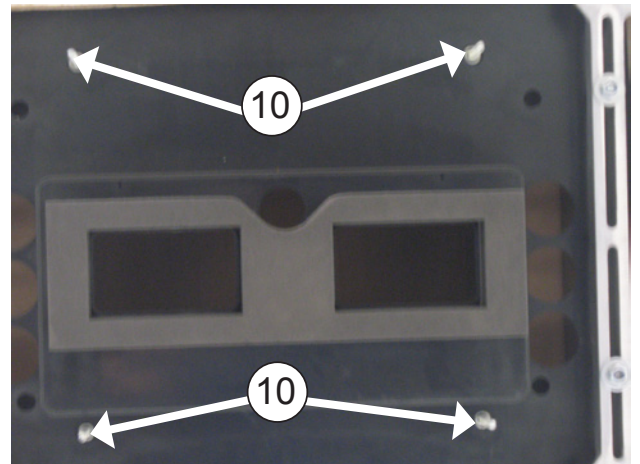
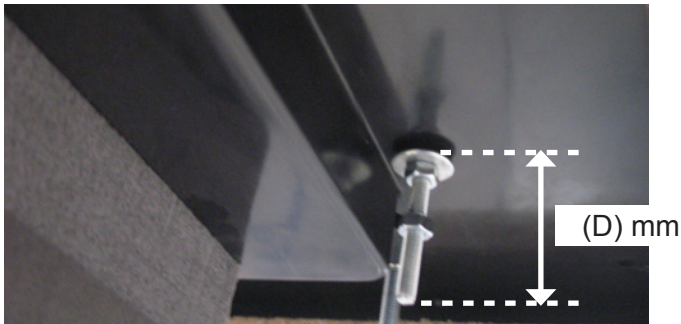

11

Inserire (1) rondella Ø 6 di gomma, (1) rondella piana Ø 6 a testa larga e (1) dado M6 su ogni vite prigioniera M6. **Stringere il dado** fino a schiacciare leggermente la rondella di gomma.

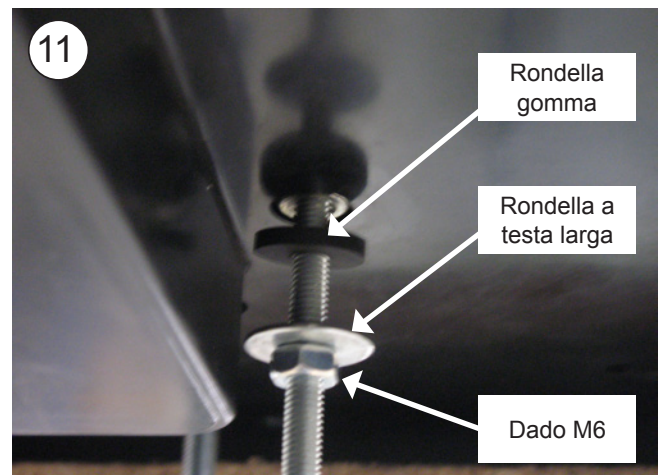

12

Inserire (1) dado M6 senza stringere su ogni vite prigioniera.

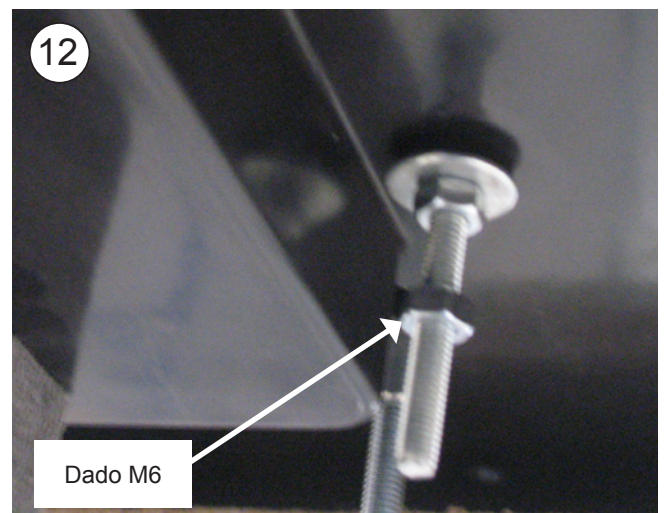

13

Tra la base e il pannello interno di distribuzione dell'aria, collegare (2) scatole a due vie del sensore antigelo (cavi bianchi) e del sensore dell'aria di ritorno (cavi neri), la scatola a 4 vie del ventilatore, (2) cavi di comunicazione e la scatola a 8 vie del cablaggio per la connessione con il controllo elettronico.

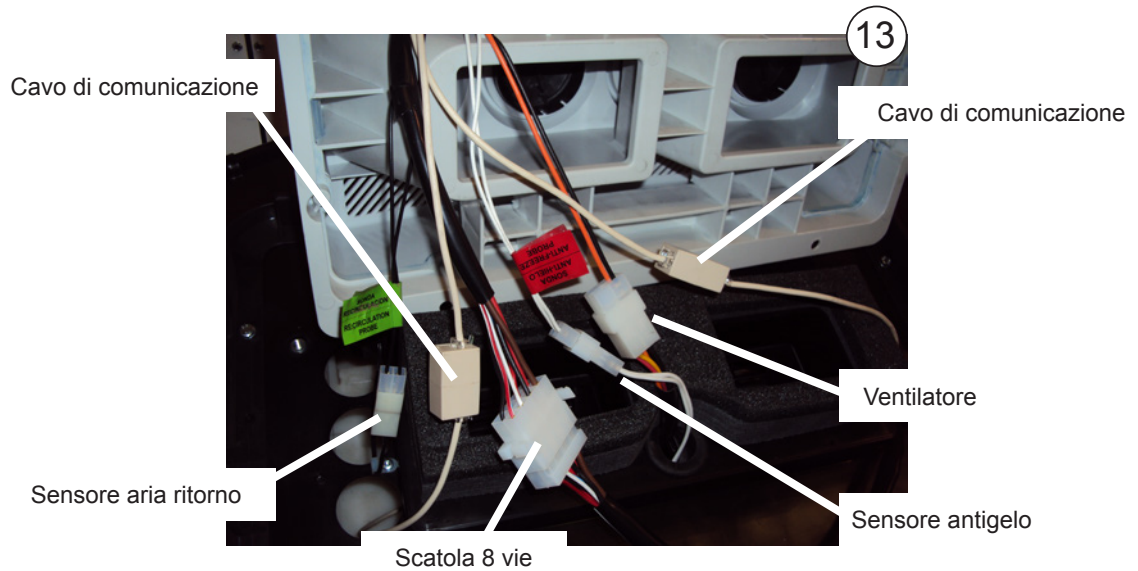



14

Posizionare il pannello interno di distribuzione dell'aria sulle viti prigioniera anteriori con (1) rondella M6 a testa larga e (1) dado M6 su ogni vite prigioniera. Stringere i dadi finché il canalizzatore del pannello interno di distribuzione dell'aria non è a battuta sulla gommapiuma superiore dell'impianto.

**Nota bene: il canalizzatore del pannello interno di distribuzione dell'aria deve essere a battuta contro la gommapiuma per evitare perdite d'aria.**

**Fare attenzione per evitare che i cablaggi restino impigliati tra il canalizzatore e la gommapiuma alla base dell'impianto.**

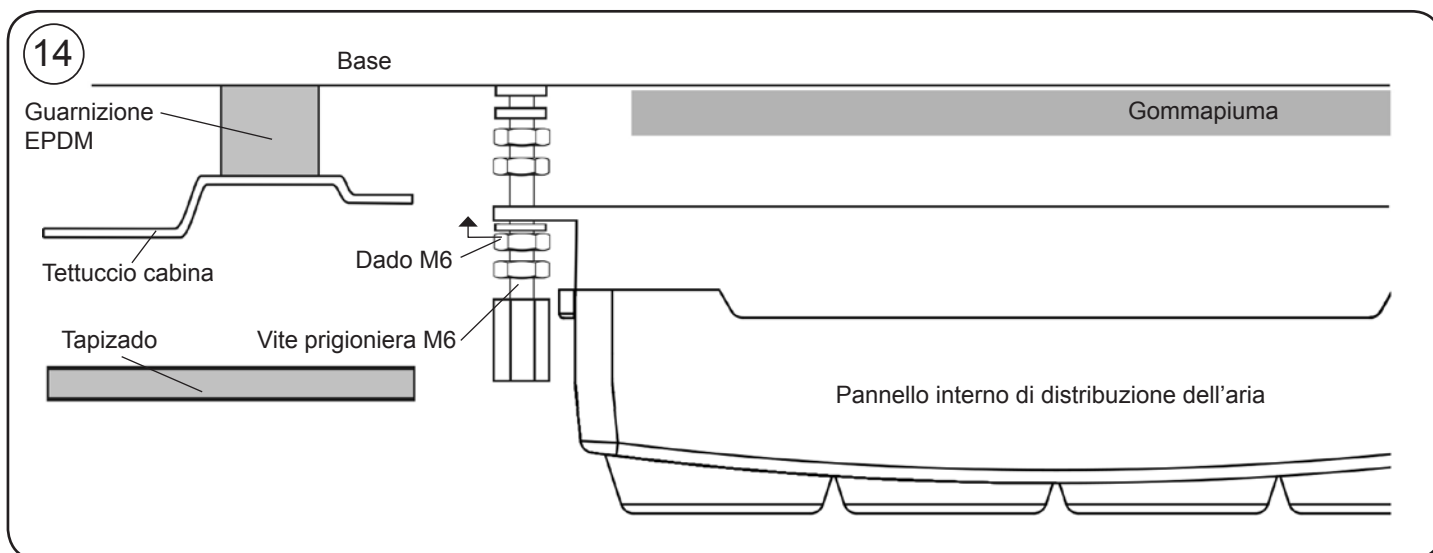

15

Stringere il dado del punto 12 fino a battuta con la parte superiore del pannello interno di distribuzione dell'aria.

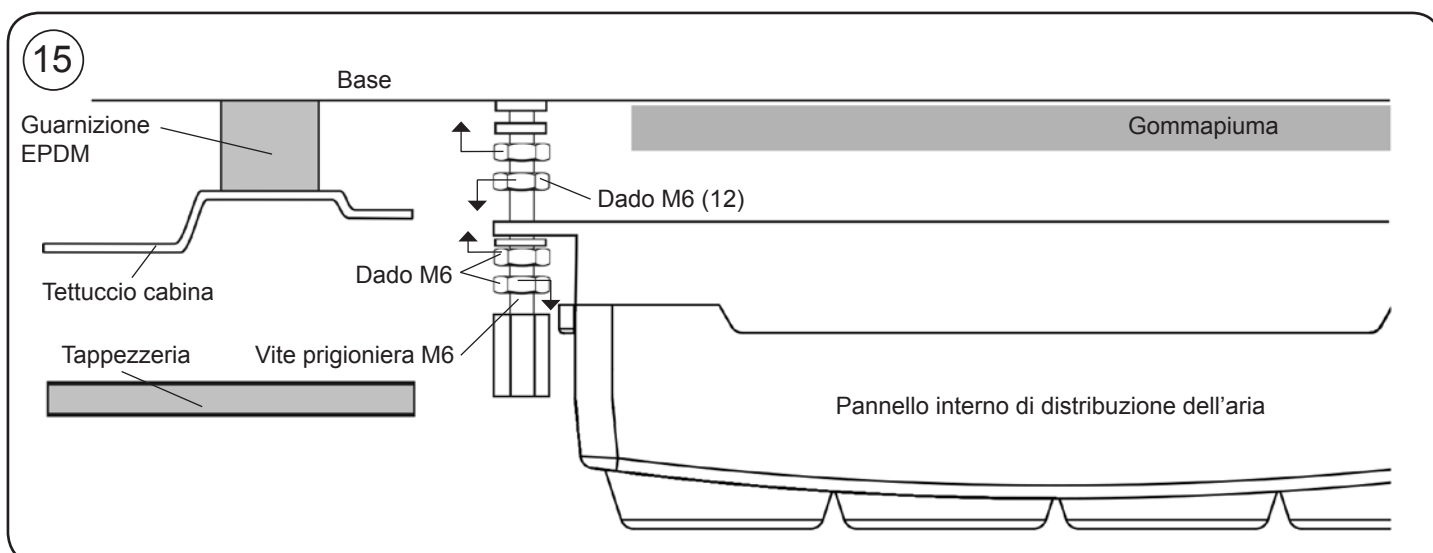

**VEICOLI CON TETTuccio APRIBILE ORIGINALE O PREMARCATO  
PER IL MONTAGGIO DELL'IMPIANTO**

**15a**

Posizionare provvisoriamente la console e centrare l'impianto nel sito più adatto del tettuccio della cabina. Una volta centrato, rimuovere la console.

**15b**

Fissare i supporti di fissaggio stringendo i dadi fino a comprimere la guarnizione EPDM esterna dell'impianto tra 3 e 6 mm.

**Importante:** per evitare eventuali infiltrazioni d'acqua all'interno della cabina, si deve assicurare il serraggio della guarnizione EPDM con la base del Compact come indicato nello **schema**.



Verificare la compressione della guarnizione EPDM usando un metro a nastro sui quattro angoli.

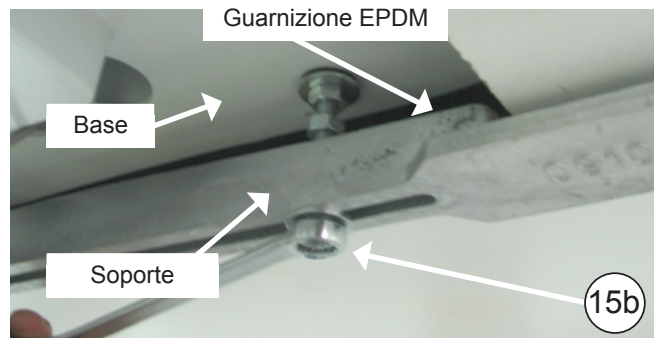
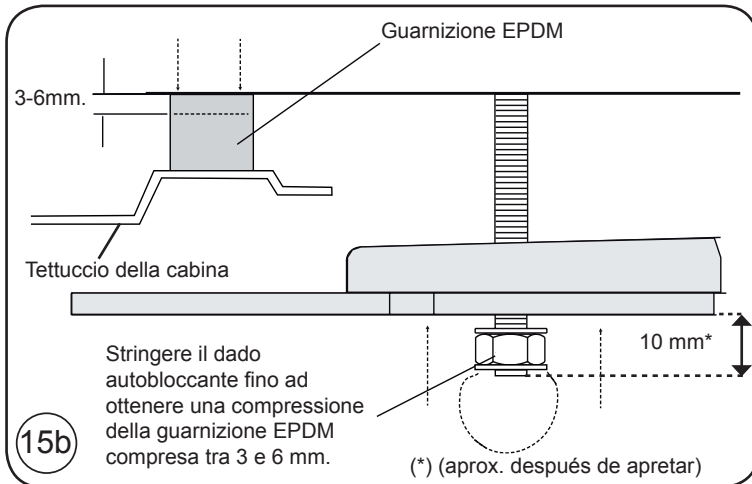

**15c**

Stringere (4) dadi M8 sul supporto e (4) sulla base del Compact.

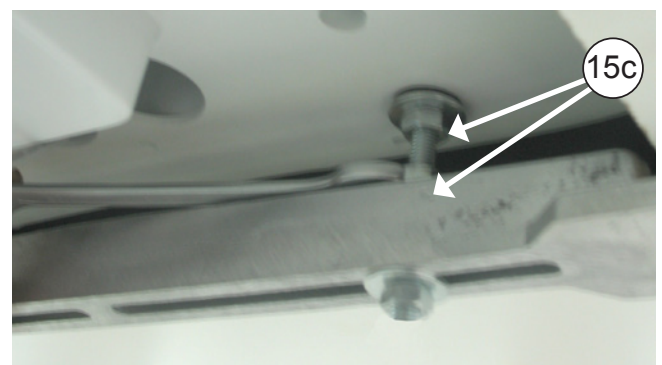

TUTTI I MODELLI

16

Inserire il dado M6 (A) dopo il dado di fissaggio del pannello interno di distribuzione dell'aria su ogni vite prigioniera. Inserire i perni esagonali M6 e avvitarli fino a lasciarli a 1 mm al di sopra della tappezzeria. Svitare i dadi M6 (A) di questo punto fino a battuta con i distanziali esagonali e stringerli contro gli stessi.

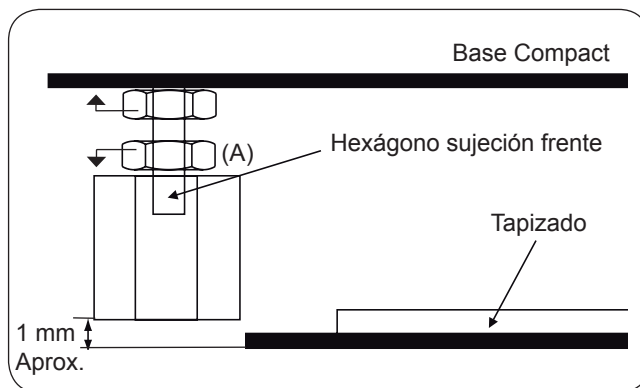

16

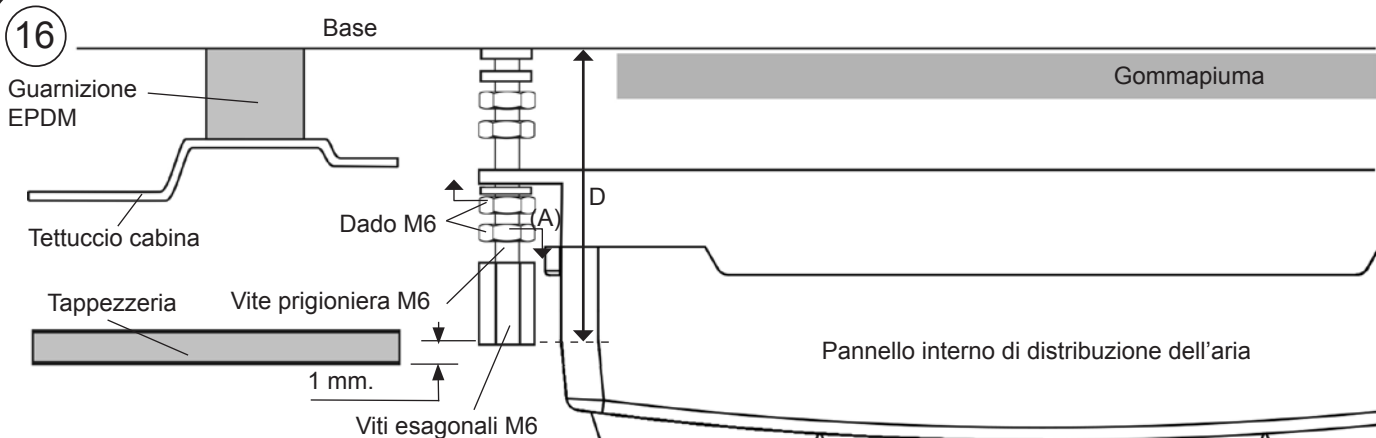

17

Fissare la console con (4) viti a brugola M6/100x15.

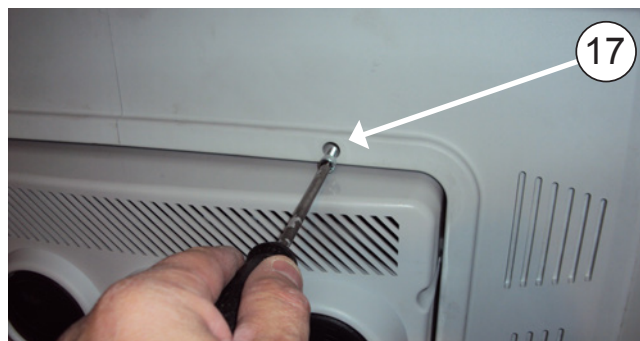

18

Coprire (4) viti a brugola M6/100x15 con gli elementi decorativi rotondi M6 di plastica.



**VEICOLI SENZA TETTuccio APRIBILE ORIGINALE O PREMARCATO  
PER IL MONTAGGIO DELL'IMPIANTO**

**Esploso fino al fissaggio dei supporti**

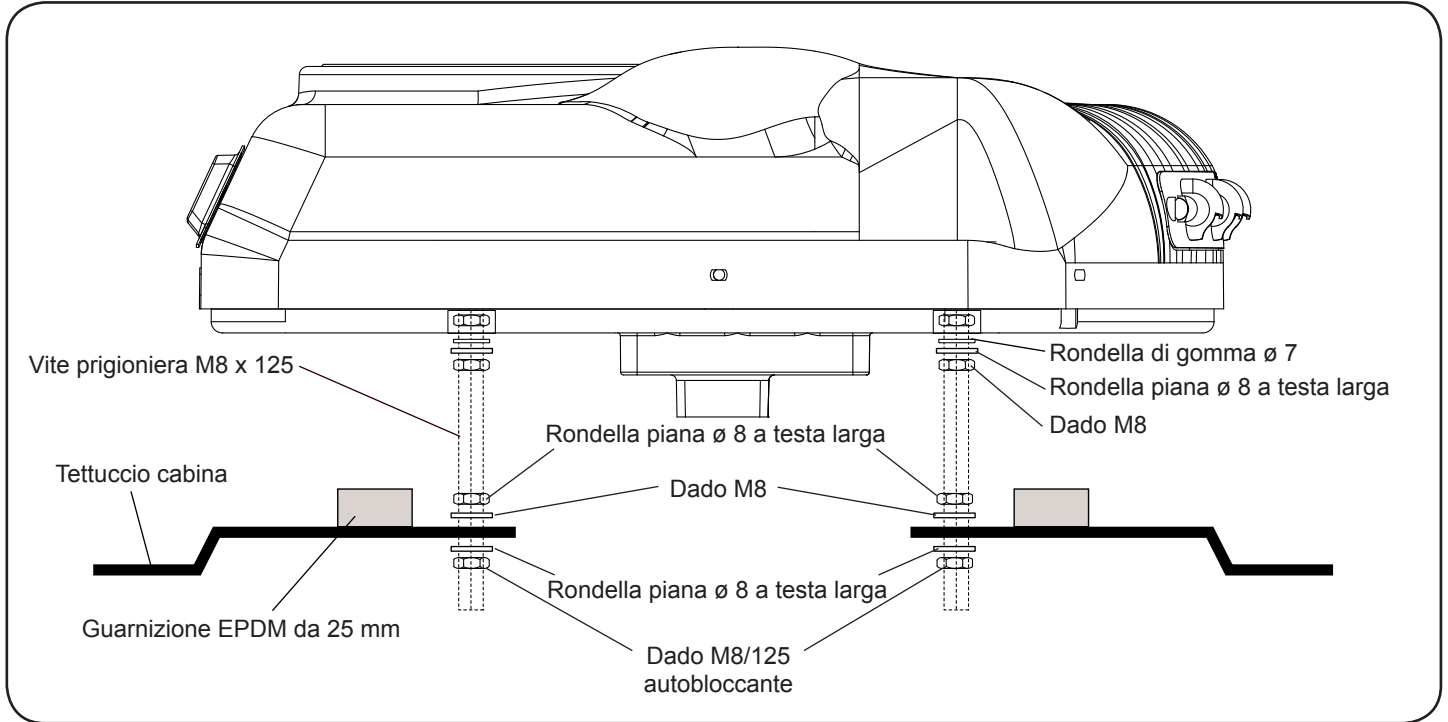

**Esploso fino al fissaggio della console**

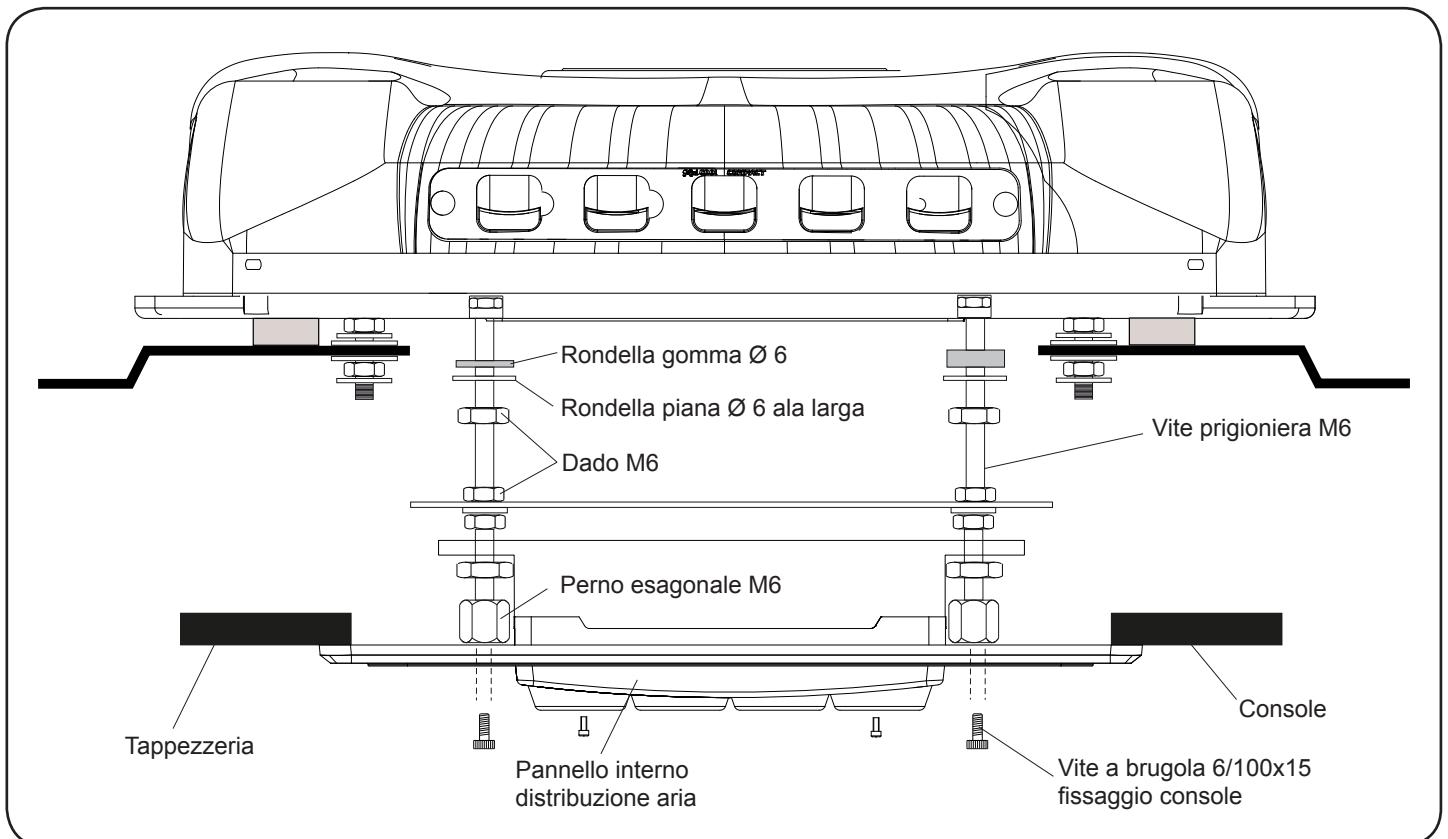

**VEICOLI CON TETTuccio APRIBILE ORIGINALE O PREMARCATO  
PER IL MONTAGGIO DELL'IMPIANTO**

**Esploso fino al fissaggio dei supporti**

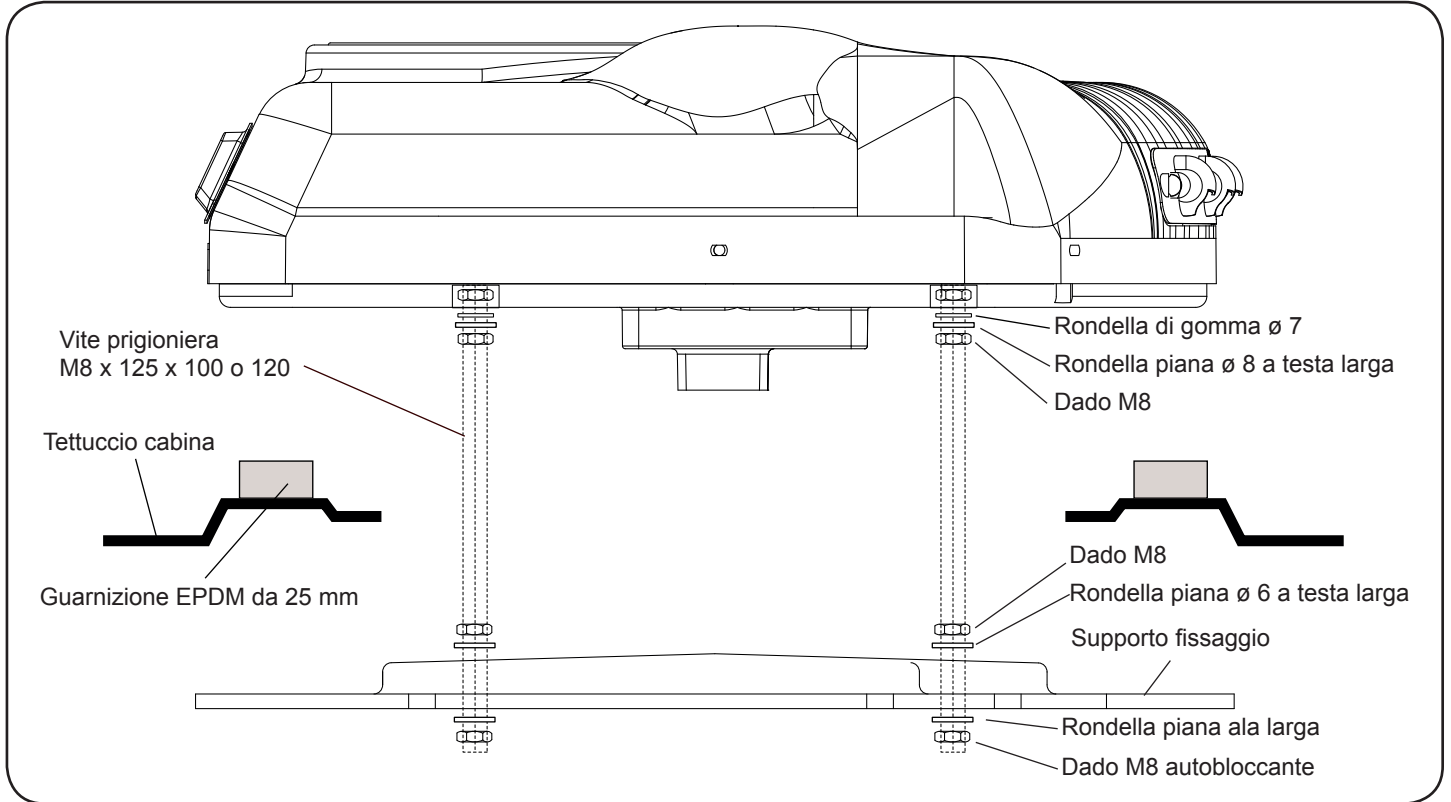

**Esploso fino al fissaggio della console**

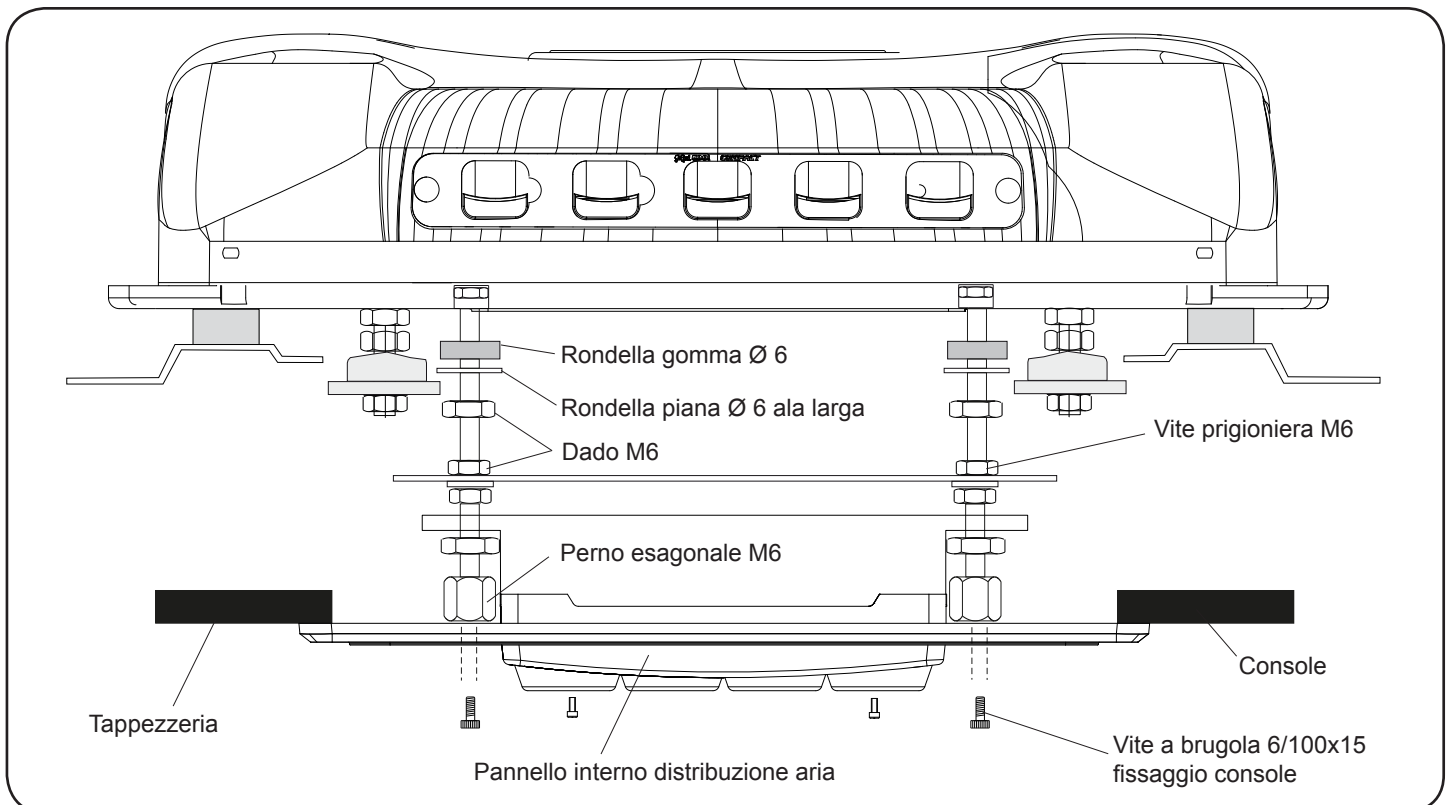



## Istruzioni particolareggiate per l'installazione del cablaggio di alimentazione

**1** Collegare il cavo di alimentazione superiore sulla parte posteriore dell'impianto e farlo passare dalla parte posteriore della cabina incollando i supporti di plastica e fissandolo con le flange.

**2** Collegare il cavo di alimentazione inferiore alla batteria, conducendolo dal passaggio originale dei cablaggi, fissato con le fascette, verso la parte posteriore della cabina, per il collegamento con il cavo di alimentazione superiore.



**Quando si collegano i cablaggi, lasciare la distanza necessaria per evitarne la rottura per i movimenti della cabina!**

**Nota bene:** dato il complesso sistema di regolazione elettronica dell'impianto, la corrente deve essere presa direttamente dalla batteria del veicolo.

**Nota bene:** per l'avviamento, vedi il **Manuale dell'utente**.

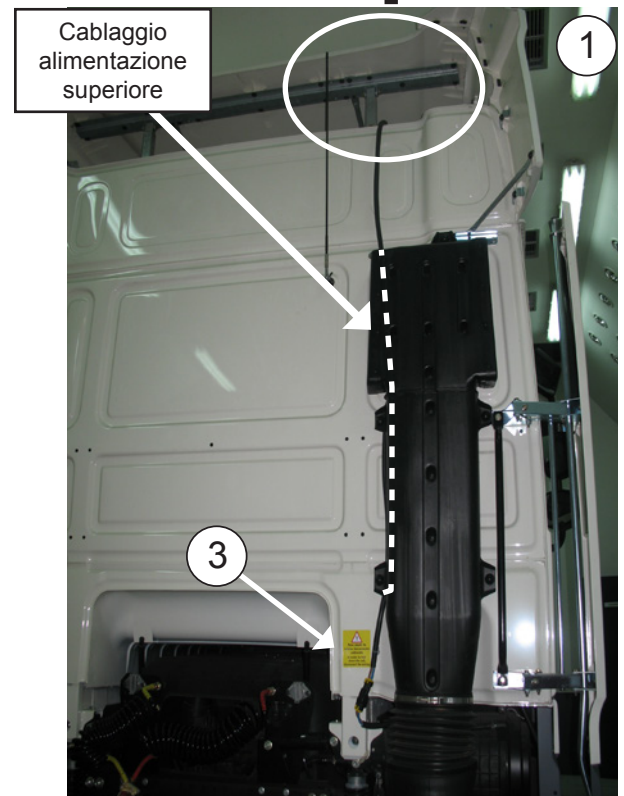
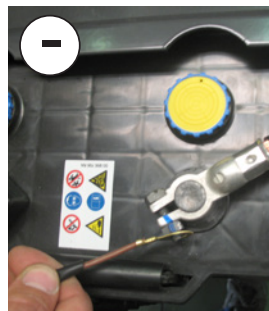
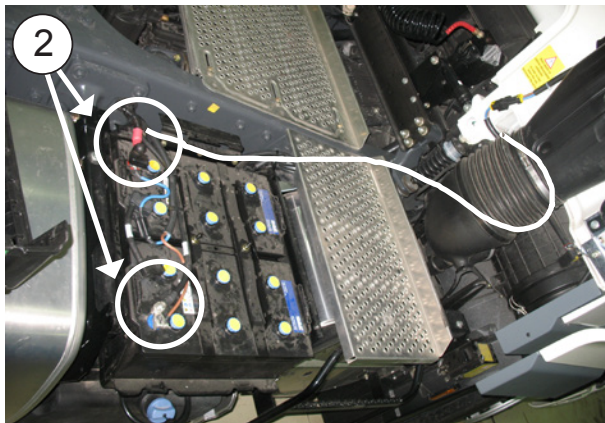

**3** Posizionare gli adesivi indicanti pericolo sulla connessione del cablaggio e sul dispositivo di sollevamento della cabina.



## Cablaggio elettrico

### AVVISO IMPORTANTE!

**Fare attenzione** a non invertire le polarità effettuando la connessione dell'alimentazione all'impianto, altrimenti il quadro comandi non si accende, l'impianto non funziona e si potrebbero verificare danni irreparabili ai moduli dei compressori.

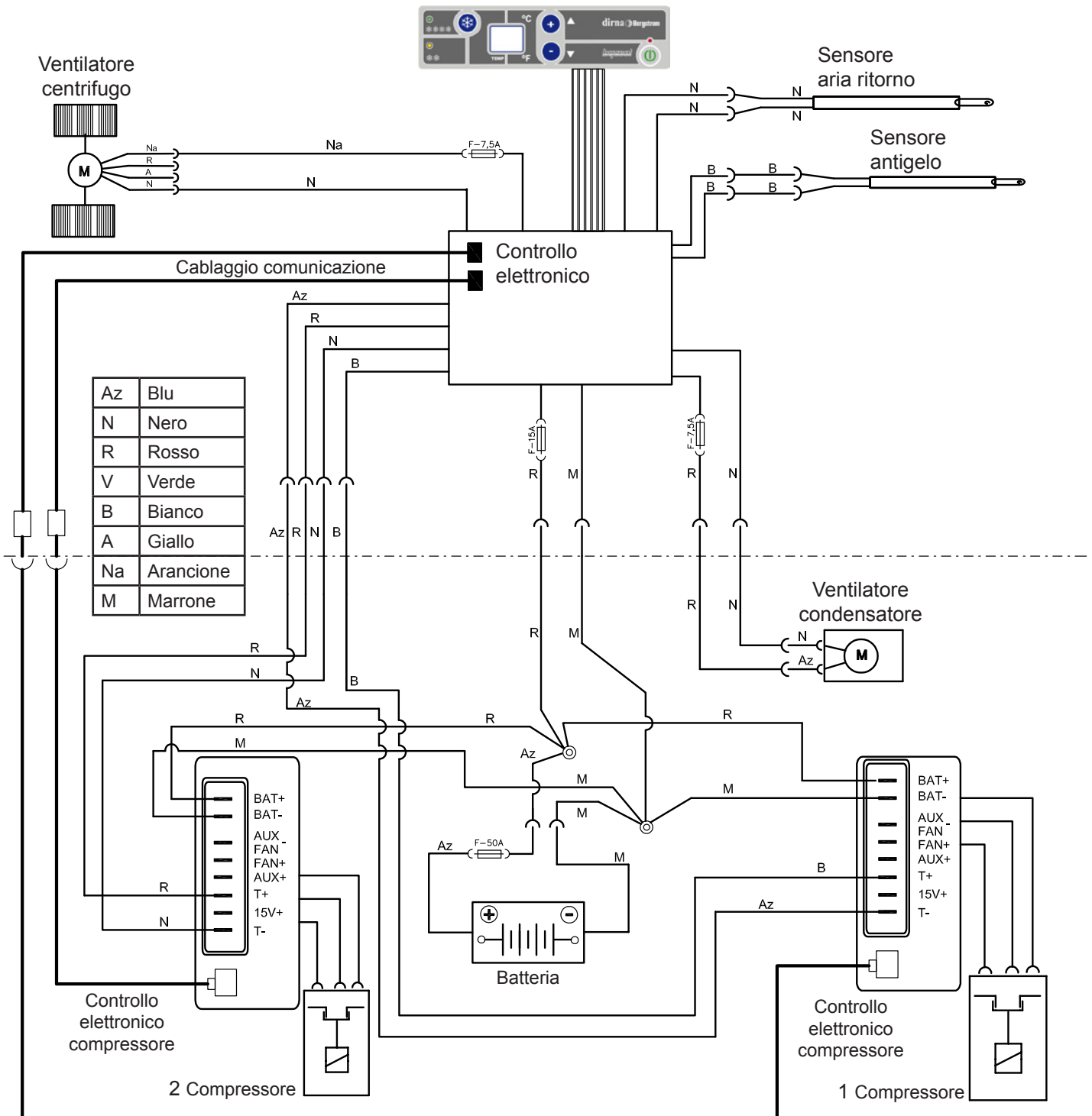



Ed:	20/01/2016
Md:	06/11/2018

b



Francisco Alonso, 6  
28806 Alcalá de Henares, Madrid  
SPAIN

Contact	Phone	Fax	E-Mail
Sales (Ventas Internacional)	+34 91 8770510	+34 91 8771158	sales@dirna.bergstrominc.com
Comercial Nacional	+34 91 8775841	+34 91 8836321	ventas@dirna.bergstrominc.com
Orders & Deliveries (Logística internacional)	+34 91 8775846	+34 91 8771158	export@dirna.bergstrominc.com
Orders & Deliveries (Logística nacional)	+34 91 8775840	+34 91 8836321	comercial@dirna.bergstrominc.com
Technical Assistance (Internacional)	+49 511 86679681	+49 511 86679710	technicalassistance@dirna.bergstrominc.com
Technical Assistance (Nacional)	+34 91 8775845	+34 91 883 6321	oblanco@dirna.bergstrominc.com

[www.dirna.com](http://www.dirna.com)

	<b>ATENCIÓN:</b>	Dirna Bergstrom se reserva el derecho de efectuar modificaciones en cualquier momento de los datos contenidos en esta publicación, por razones técnicas o comerciales.
	<b>NOTE:</b>	<i>For technical and commercial reasons, Dirna Bergstrom reserves the right to change the data contained in this brochure.</i>
	<b>ATTENTION:</b>	Dirna Bergstrom se réserve le droit d'effectuer à tout moment des modifications des données reprises sur cette publication, pour des raisons techniques ou commerciales.
	<b>HIWEIS:</b>	<i>Dirna Bergstrom behält sich vor, aus technischen oder kaufmännischen Gründen jederzeit Änderungen der Angaben dieser Veröffentlichung vorzunehmen.</i>
	<b>ATTENZIONE:</b>	Dirna Bergstrom si riserva il diritto di effettuare modifiche in qualsiasi momento ai dati contenuti in questa pubblicazione, per motivi tecnici o commerciali.