

CE

dirna  Bergstrom®

bycool!
green line

COMPACT 3.0

VOLVO



Instrucciones de Montaje

Mounting Instructions

Instructions de Montage

Montageanweisungen

Istruzioni di Montaggio

ES Spanish

EN English

FR French

GE German

IT Italian



F-4218 rev.01

1001217164

Recomendaciones Para el montaje

- Antes de iniciar el montaje leer las instrucciones y seguirlas durante el proceso de instalación.
- Usar las herramientas adecuadas para cada operación.

Electricidad

- Desconectar la llave de contacto.
- Desconectar la batería antes de empezar el montaje.
- Asegurar el conexionado de los componentes eléctricos, verificando su correcto encaje.

Atención

Si durante el montaje el equipo se inclina, se deberá esperar un mínimo de 60 minutos desde que el equipo quede en posición horizontal antes de ponerlo en funcionamiento.

Atención

Al instalar el equipo de aire acondicionado en el techo se debe proteger la parte superior de la cabina con un paño ó manta protectora para evitar posibles arañazos. Al instalar **Compact** en el techo hay que tener en cuenta que, normalmente, las cabinas que vienen provistas de escotilla, tienen una estructura suficiente para soportar el peso del equipo. Sin embargo, cuando no ocurra así y sea necesario realizar corte en el techo ó incluso si en el caso de llevar escotilla el material no es lo suficientemente resistente (caso de techo de fibra, plástico, etc...) es el instalador el que debe decidir, **bajo su responsabilidad**, sobre la necesidad de reforzar el techo para evitar posibles deformaciones, roturas, entradas de agua, etc... habilitando los medios para que esto no ocurra.

Herramientas

Juego de Llaves Torx

Juego de Llaves Allen

Llave fija 10, 13, 14

Tijeras

Flexómetro

Documentación incluida

Instrucciones de montaje 1001217164

Manual del usuario 1001218019

Diagnos de averías 1001218025

Garantía 220AA10017

Simbología



Frágil





Atención corte!



Riesgo eléctrico

Advertencias

 El personal instalador debe poseer una formación suficiente en Aire Acondicionado de vehículos.

 **dirna Bergstrom, .s.l.** queda exenta de responsabilidad si se producen averías que procedan de una inadecuada manipulación ó instalación del equipo, ó por modificaciones y sustituciones efectuadas sin nuestra expresa autorización por escrito.

 **Equipo precargado con gas refrigerante.** en cada circuito. (**No manipular el circuito de gas refrigerante**).

 Véase **procedimiento de garantía** del producto incluido en **Diagnos de Averías**.

 Véase **Manual de Usuario** del equipo para el correcto funcionamiento del mando a distancia y del panel de control.

 Al finalizar la instalación se debe entregar al usuario: **Manual del Usuario, Garantía y Diagnos de averías**.

 Antes de empezar con el montaje, montar rejilla entrada aire delantera.



1 Desmontar tapa escotilla, marco interior y entregar al cliente

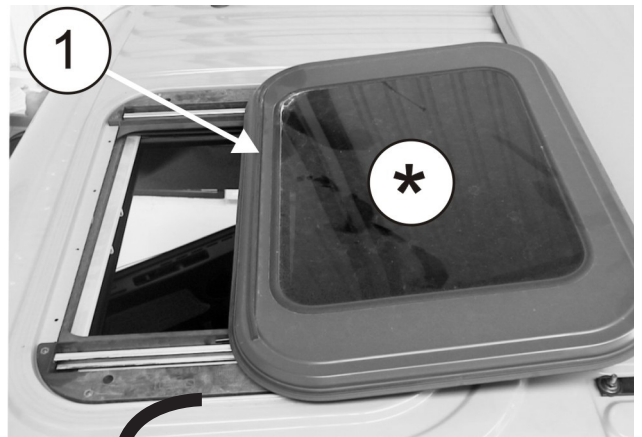

2 Pegar junta EPDM de 30x25mm, alrededor del corte o del hueco de escotilla.





COMO CORTAR LA JUNTA EPDM PARA EVITAR FILTRACIÓN DE AGUA EN LA CABINA

- A- Pegar la junta, manteniendo 100 mm de papel protector por cada lado.
- B- Quitar los dos piezas de papel.
- C- Pegue presionado ambos finales.

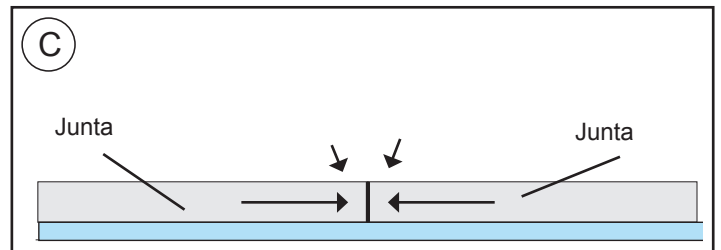
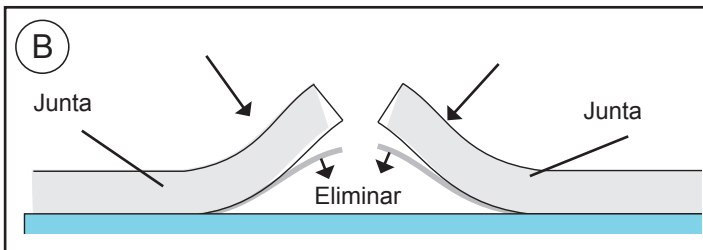
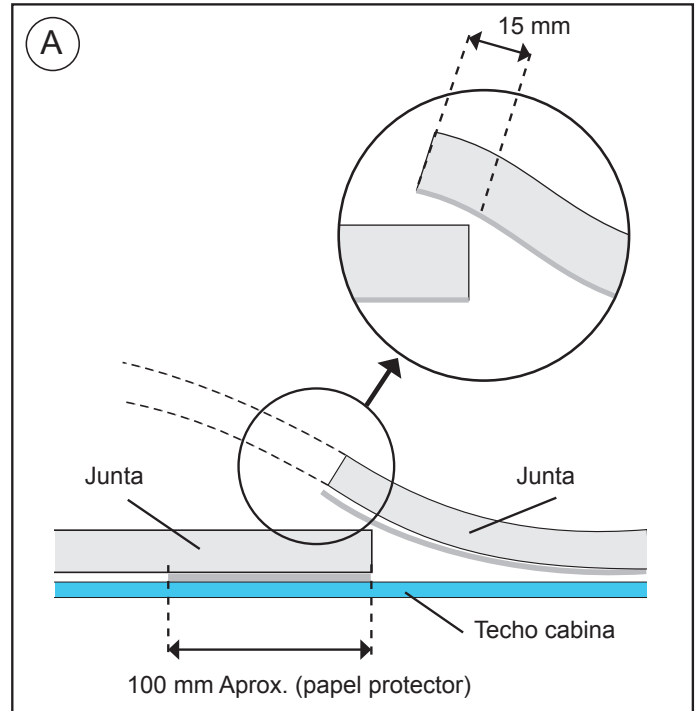

3

EXTERIOR CABINA:

Posicionar el Compact en el hueco de la escotilla.

¡Atención! Al colocar el equipo encima del hueco escotilla, revisar que las salidas de desagüe no queden obstruidas por la junta EPDM.

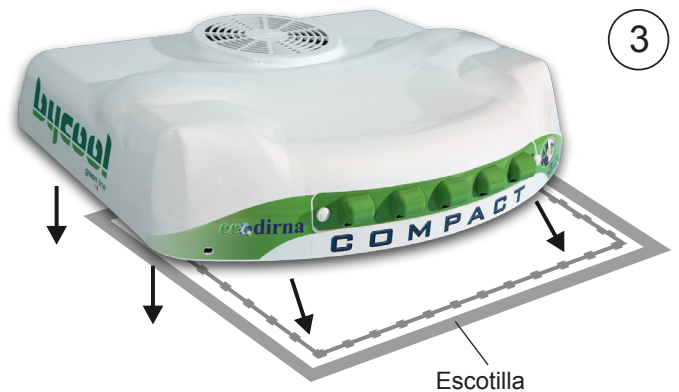

4 Colocar canalizador gomaespuma quedando la parte más blanda en la base del equipo.

Atención: Dependiendo de la cabina, es posible que sea necesario usar los (2) canalizadores suministrados para que el panel de distribución de aire quede totalmente ajustado con ellos.



5 INTERIOR CABINA:

Roscar 5 mm aproximadamente (4) espárragos 8/125x100-70 o 120, la medida se elegirá tras presentar los soportes de sujeción y teniendo en cuenta que los espárragos deben sobresalir de los mismos por la parte inferior unos 20 mm.

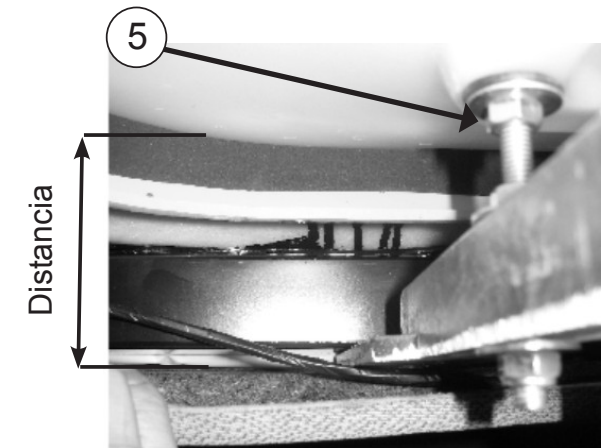
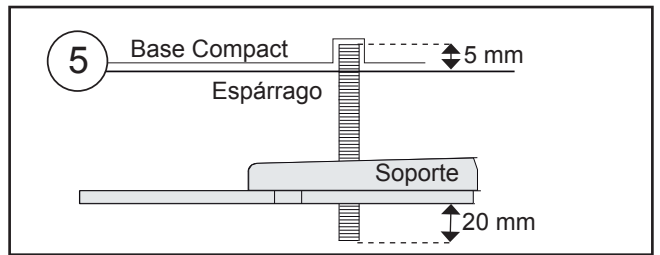

6 Colocar (1) arandela Ø 7 de goma, (1) arandela plana Ø 8 ala ancha, (2) tuerca M8 y (1) arandela plana Ø 8 ala ancha , en cada uno de los espárragos anteriores; siguiendo dicho orden.

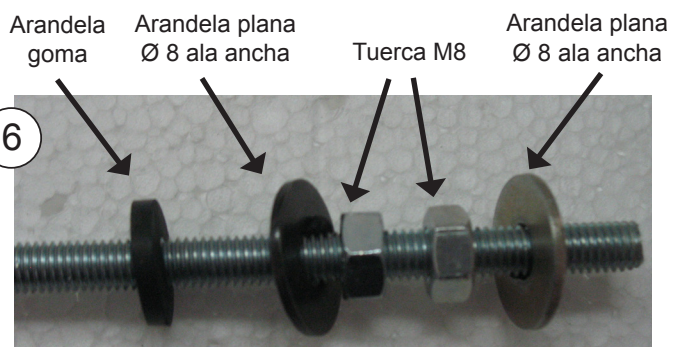

7 Colocar (2) soportes sujeción, con (1) arandela y (1) tuerca autoblocante M8, **sin llegar a apretar.**

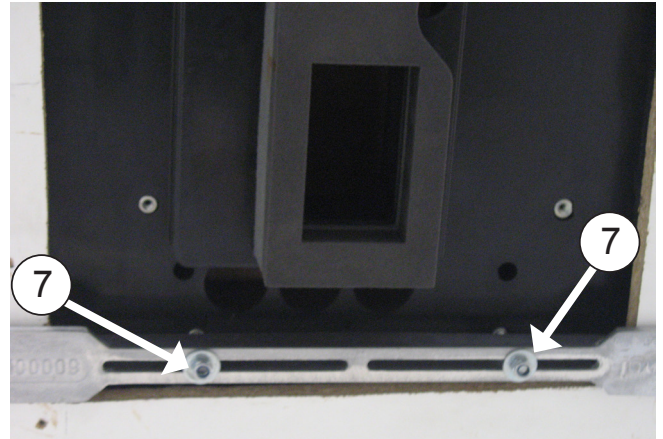

8 Roscar 10 mm (4) espárragos M6, donde se indica, según distancia (D) del esquema del punto 10.

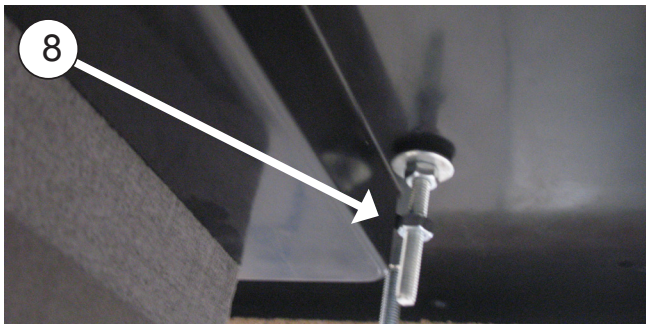
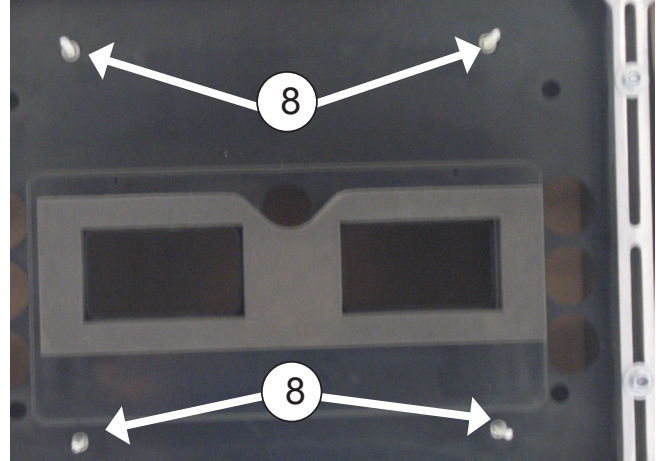

9 Colocar (1) arandela Ø6 de goma, (1) arandela plana Ø6 ala ancha y (1) tuerca M6, sobre cada uno de los espárragos de M6. A continuación apretar la tuerca hasta que la arandela de goma quede un poco oprimida.

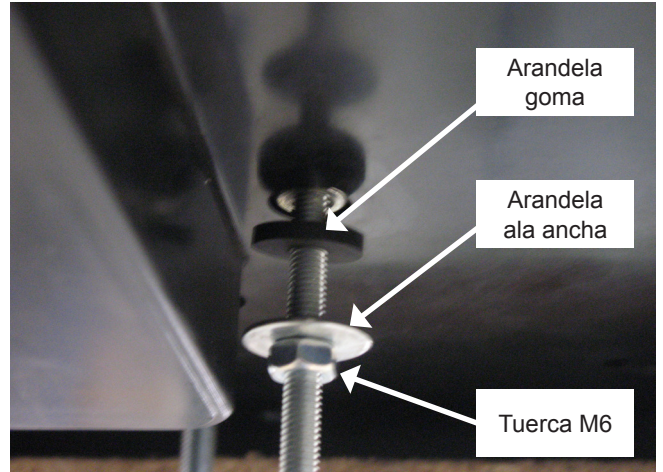

9a Colocar (1) tuerca M6 **sin apretar** en cada espárrago.

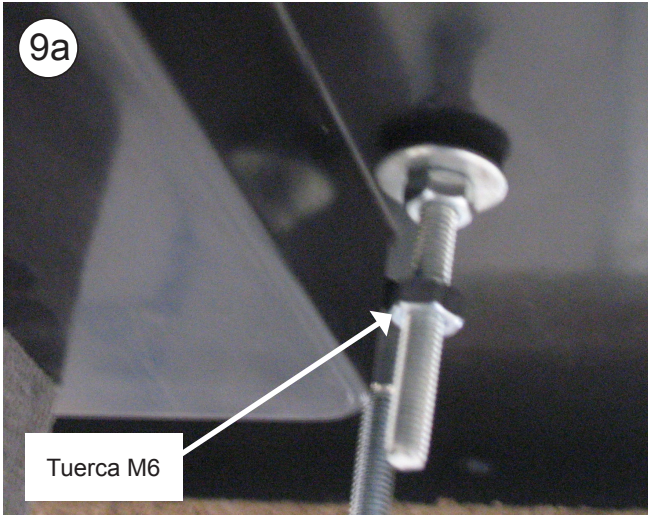

9b Entre la base y el panel interior de distribución de aire, conectar (2) cajas de dos vías de sensor antihielo (cables blancos) y sensor aire de retorno (cables negros), caja de 4 vías del soplador, (2) cables de comunicación y caja de 8 vías de cableado a conexión con control electrónico.

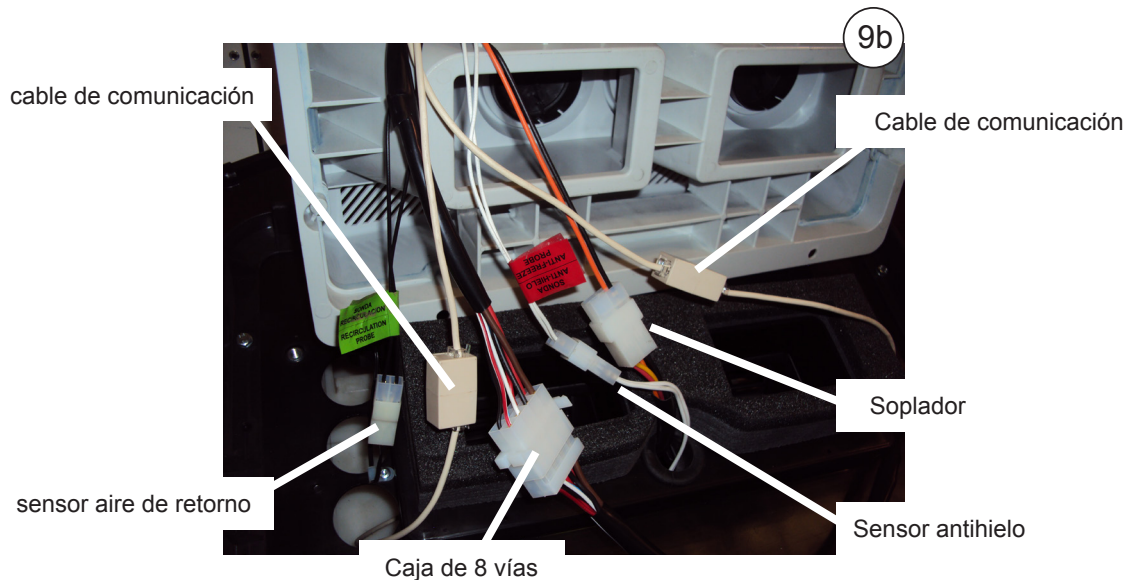

10

Colocar panel de distribución de aire en los espárragos anteriores con (1) arandela M6 ala ancha y (1) tuerca M6 en cada espárrago. Apretar tuercas hasta que el canalizador del panel de distribución de aire haga tope en el acoplamiento canalizador colocado en el equipo.

Importante: El canalizador de gomaespuma debe hacer tope contra la goma espuma superior del equipo para evitar fugas de aire.

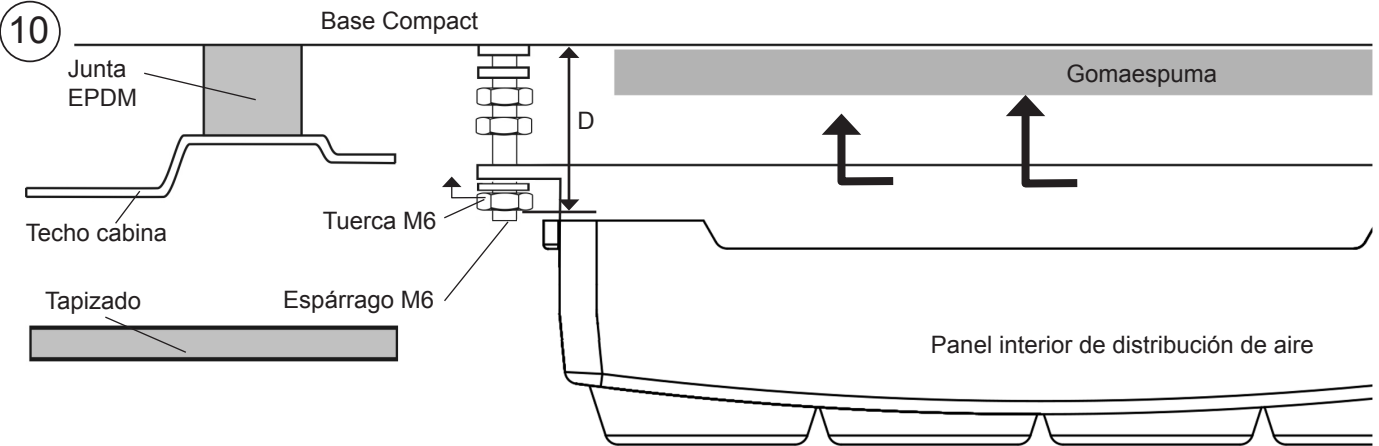

11

Apretar tuerca del punto 9a hasta hacer tope con la parte superior del panel de distribución de aire.

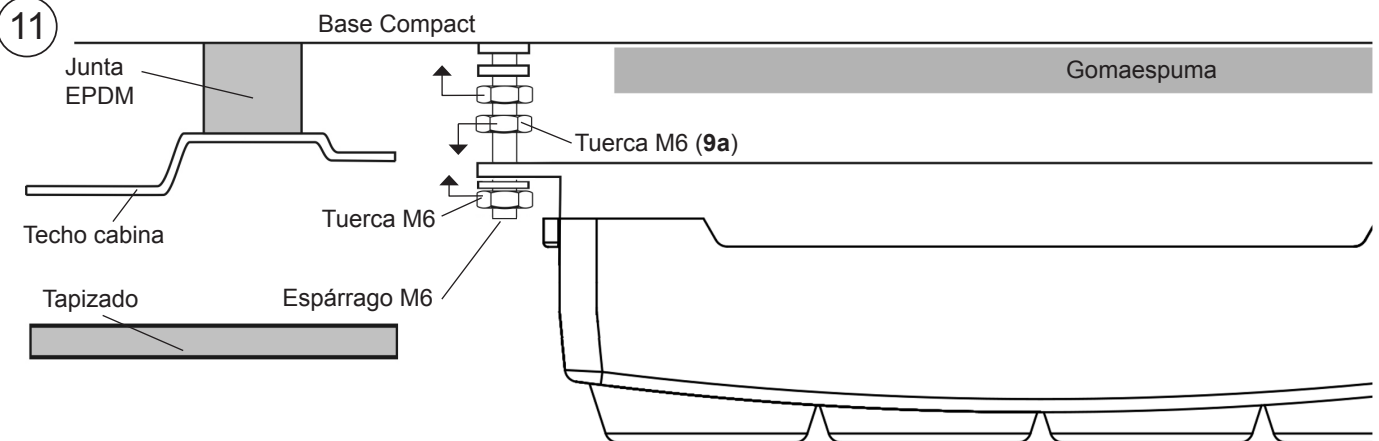

12 Presentar consola con tornillos originales y centrar el equipo en la posición mas idónea, hasta hacer coincidir los tornillos originales en su ubicación.



13 Fijar los soportes de sujeción apretando las tuercas hasta el apriete de la junta de EPDM exterior del equipo entre 3 y 6mm.

Importante: Para evitar posibles filtraciones de agua al interior de la cabina se debe asegurar el apriete de la junta EPDM con la base del Compact tal y como se indica en el **esquema**.



Comprobar la compresión de la junta EPDM usando un flexómetro en las cuatro esquinas.

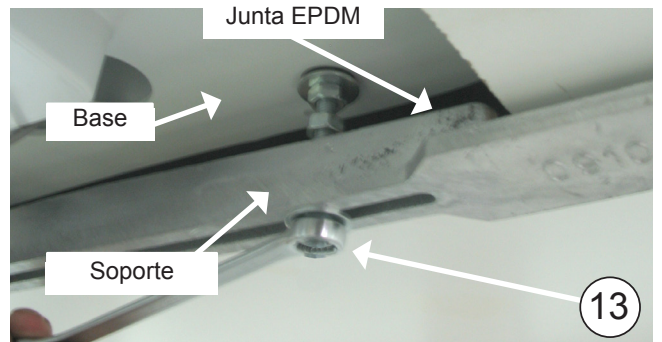
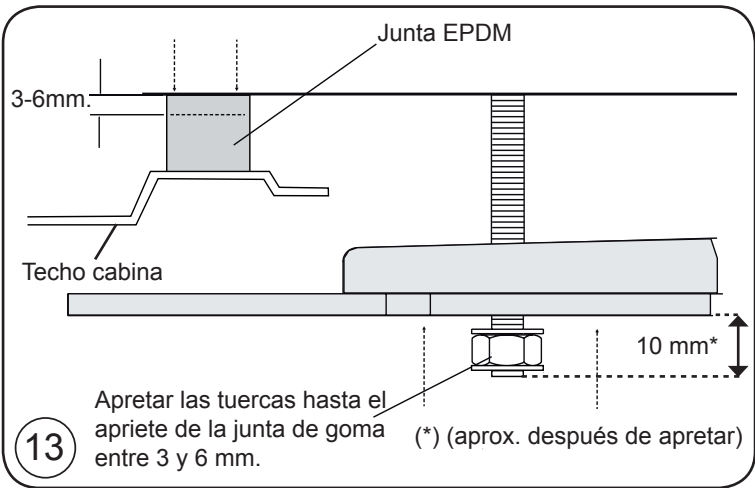

14 Apretar (4) tuercas M8 al soporte y (4) a la base del Compact.

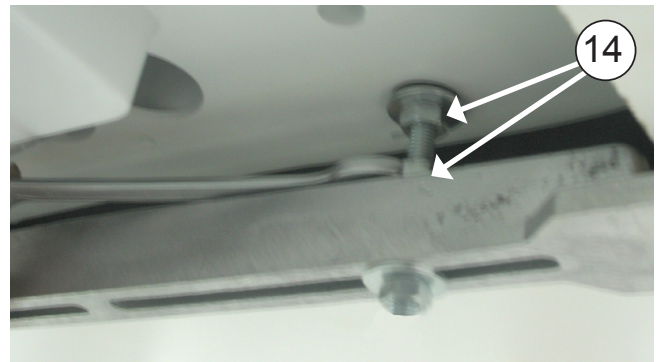

15

Colocar consola con (6) tornillos originales.



Vista explosionada hasta la fijación de los soportes

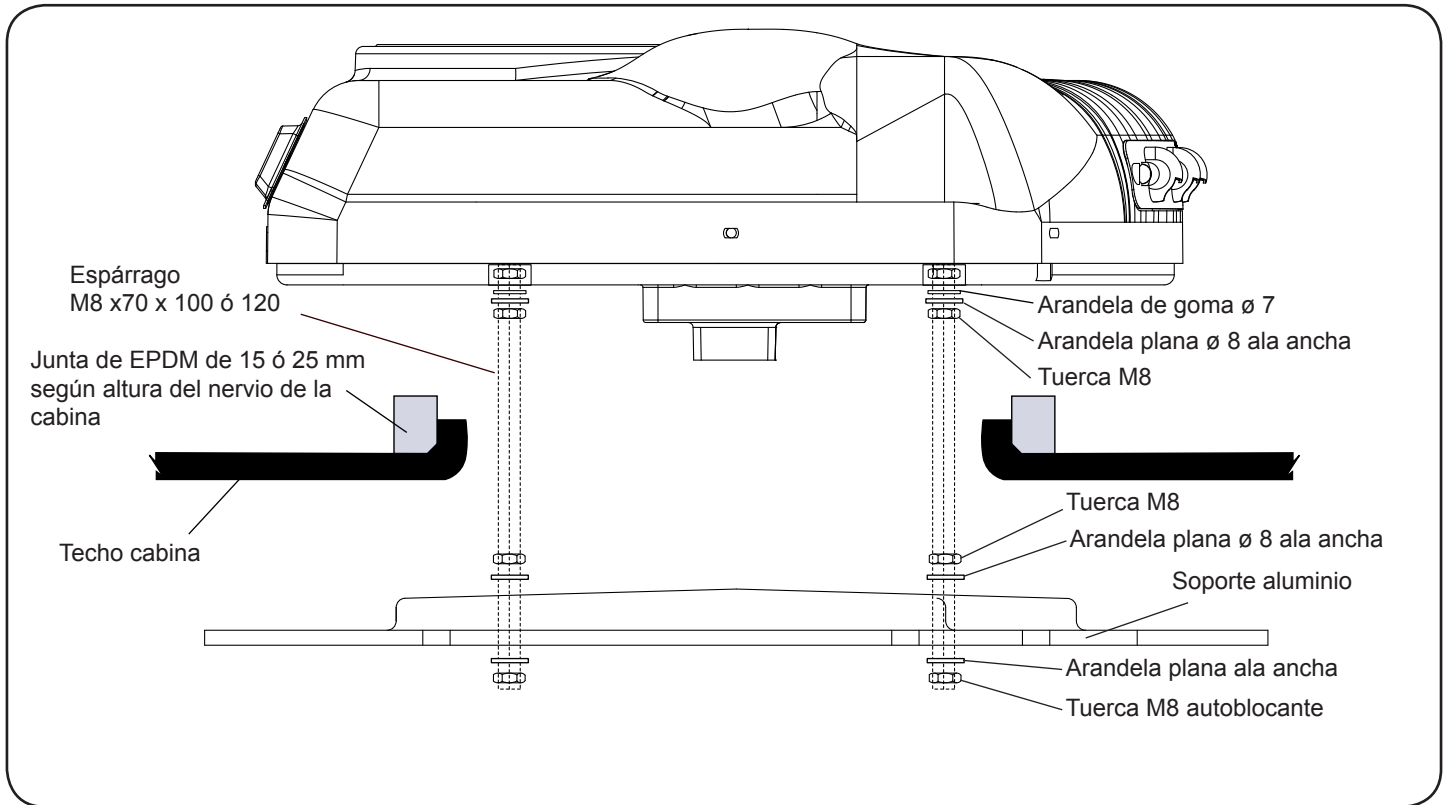

Vista explosionada hasta la fijación de las consolas

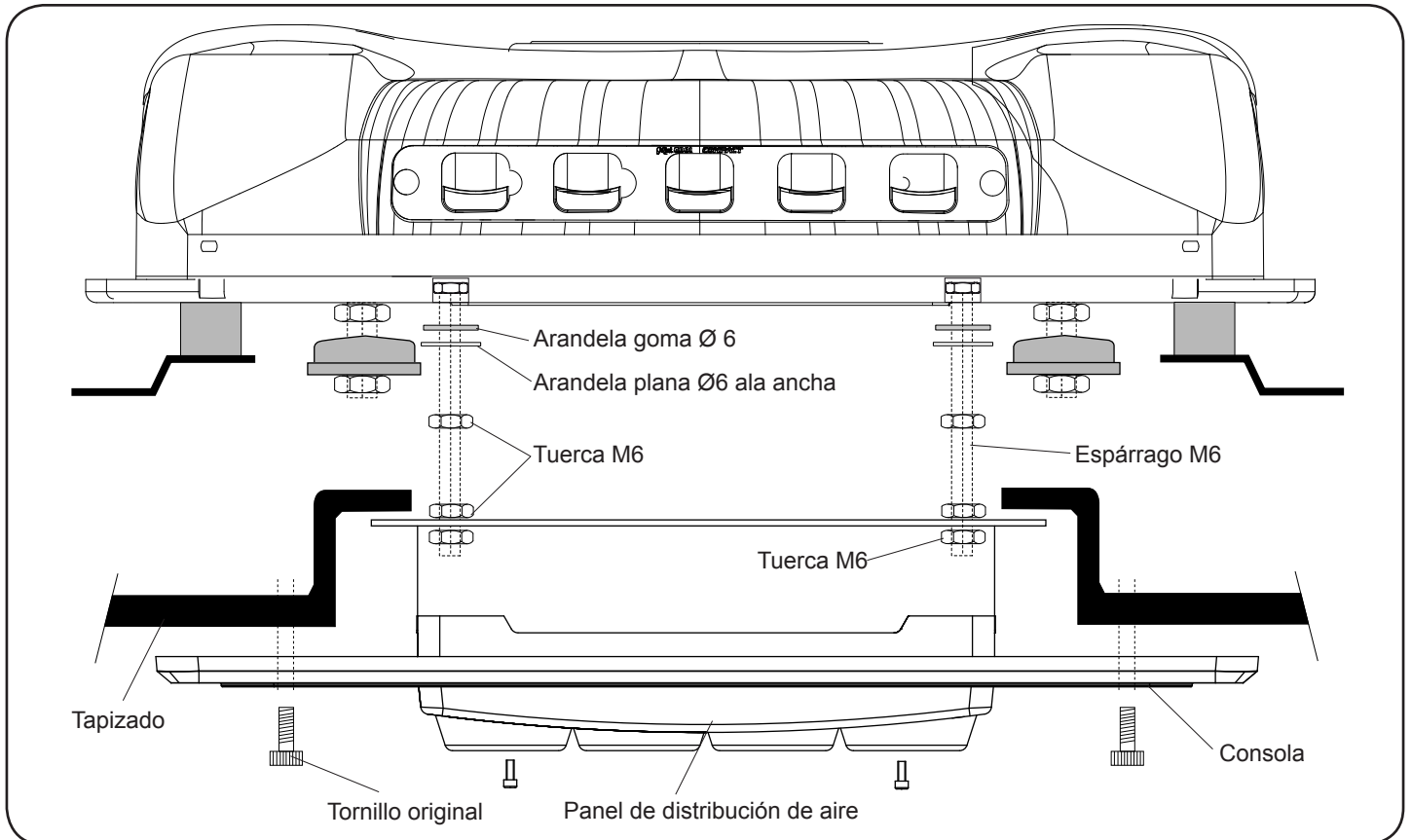

Instrucciones detalladas sobre instalación del cableado de alimentación

1 Conectar clema del cable de alimentación con la clema del equipo y pasar cableado por detrás del tubo de admisión.

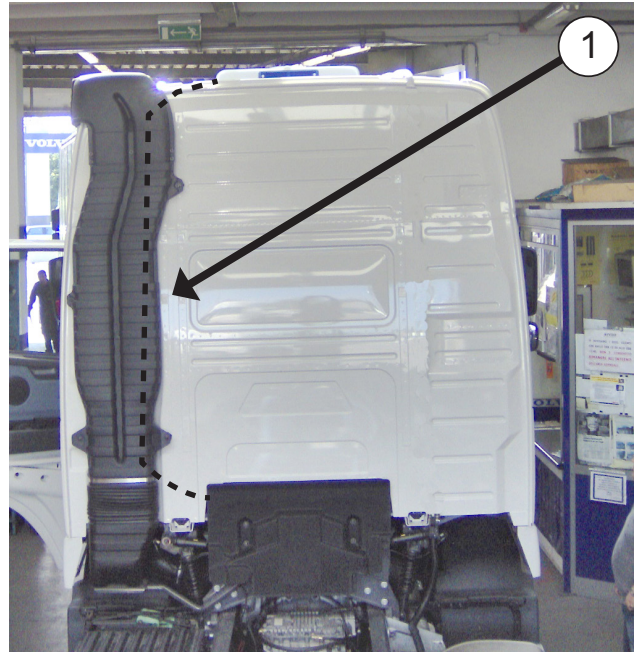
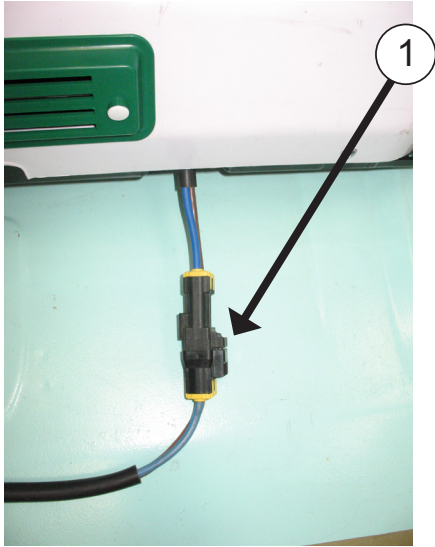

2 Abatir cabina y llevar cable por el lugar indicado hasta la toma de positivo situada en la parte delantera de la cabina.

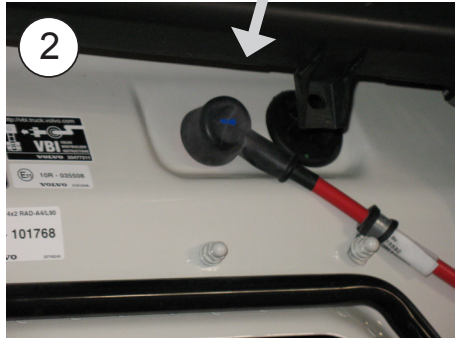
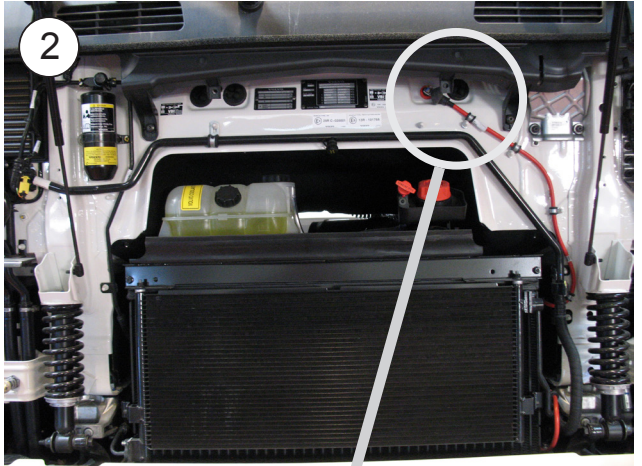
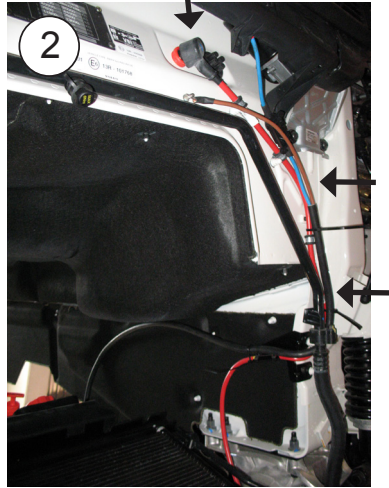
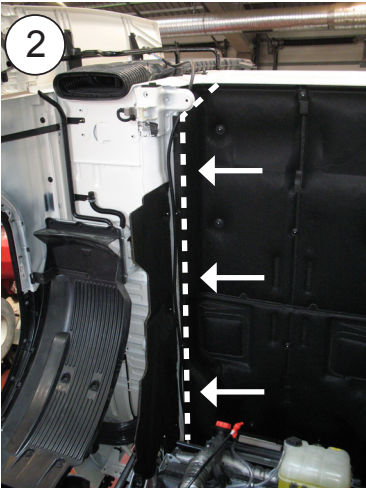

3 Desmontar tuerca M6 y tuerca M8 de toma (+) y conectar cableado de alimentación como se indica.

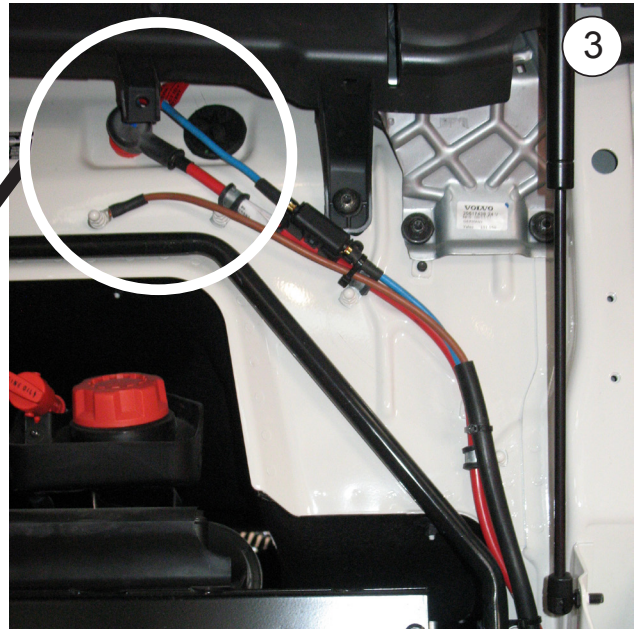
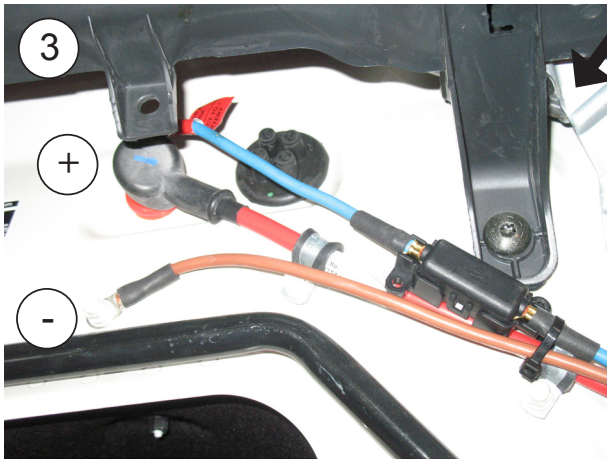

4 Fijar cableado con bridas a cable original.



5 En parte inferior de la cabina fijar con abrazaderas a espárragos originales.



6 Abatir cabina y dejar en posición de marcha, perder cableado sobrante detrás del tubo de admisión.



Esquema eléctrico

¡AVISO IMPORTANTE!

Precaución de no invertir las polaridades al conectar la alimentación en el equipo. Si esto sucediera la placa no se encenderá, el equipo no funcionará y se producirán daños irreparables en los módulos de los compresores.

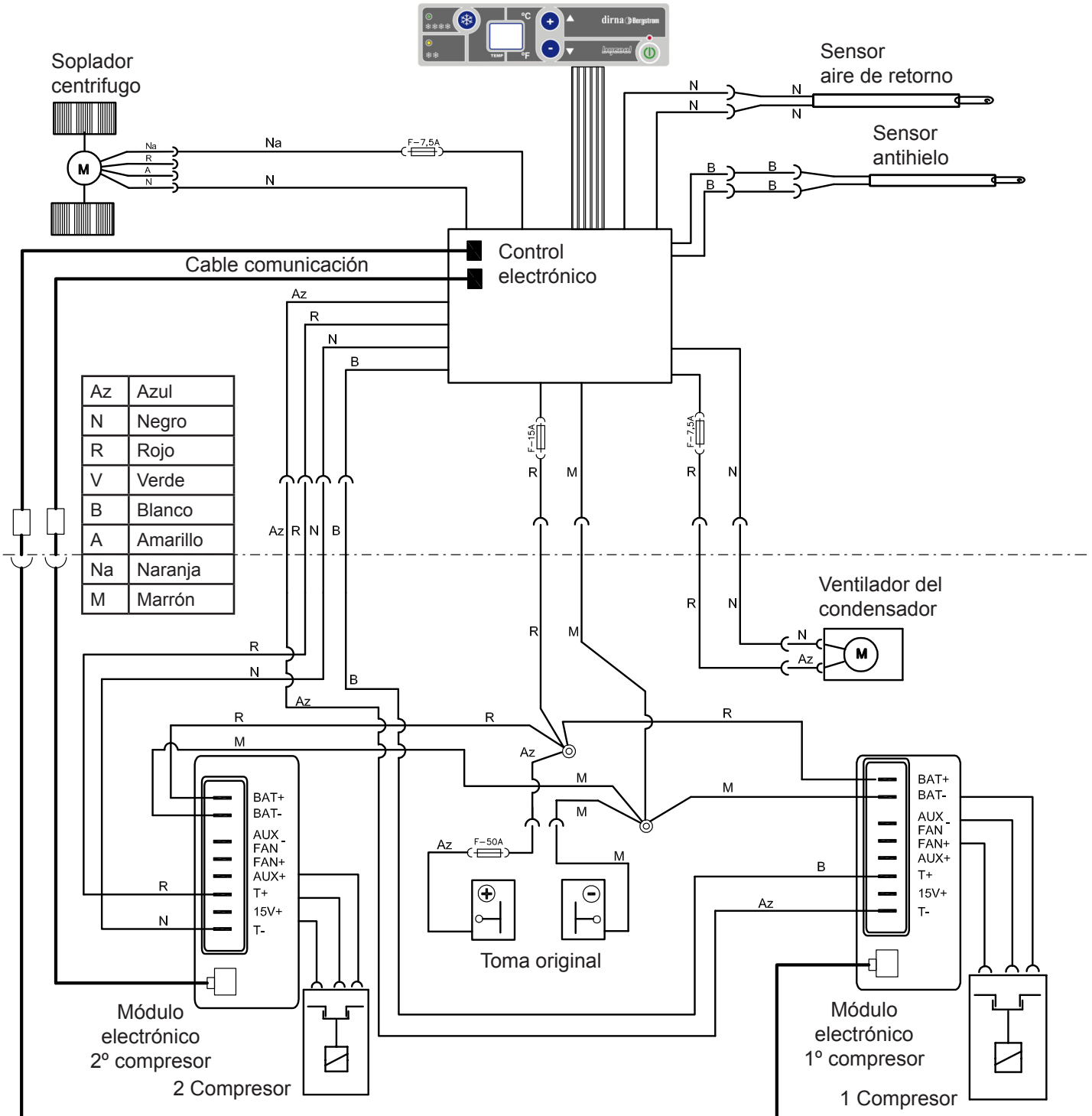

Assembly Recommendations

- Before starting assembly, please read instructions and follow them during installation process.
- Use the adequate tools for each operation.

Electricity

- Disconnect ignition key.
- Disconnect battery before starting assembly.
- Make sure electric components are securely connected, checking their correct fitting.

Warning

If the unit slants during assembly, wait for at least 60 minutes with the unit in horizontal position before starting it up.

Warning

When installing air conditioning equipment on roof, the upper cabin part must be protected with a cloth or a protective blanket to avoid possible scratches. When installing **Compact** on roof, take into account that, normally, cabins equipped with a hatch have a strong enough structure to hold equipment weight. However, if it is not the case and it is necessary to carry out a cut in the roof or, although it has a hatch, the material is not resistant enough (*if roof is made of fibre, plastic, etc...*), it is the installer who will have to decide, under his responsibility, if it is necessary to reinforce the roof to avoid possible deformations, breaks, water entries, etc., habilitating the means required to stop it from occurring.



Tools

- Torx wrenches set
- Allen wrenches set
- Open-jawed spanner 10, 13, 14
- Scissors
- Flexo-meter







Documentation included

Mounting instructions	1001217164
User's guide	1001218019
Troubleshooting	1001218025
Warranty	220AA10017

Symbology

-  Fragile
-  Beware of cuts!
-  Electrical hazard

Warnings

-  The installing personnel must have a sufficient training in vehicles air conditioning.
-  **dirna Bergstrom, s.l.** shall not be responsible for breakdowns or damages coming from an inadequate handling or installation of the equipment or from modifications and substitutions carried out without our express and written authorisation.
-  **Equipment pre-charged with refrigerating gas. (Do not handle refrigerating gas circuit).**
-  Please see product **warranty procedure** included in **Troubleshooting**.
-  Please see equipment **User's Guide** for its correct functioning of the remote control and control panel.
-  Once installation is finished, the following documents must be handed over to the user: **User's Guide, Warranty and Troubleshooting**.

 Mount the front air input grille before starting assembly.



1 Dismount the hatch cover and the inner frame, and give to the customer.

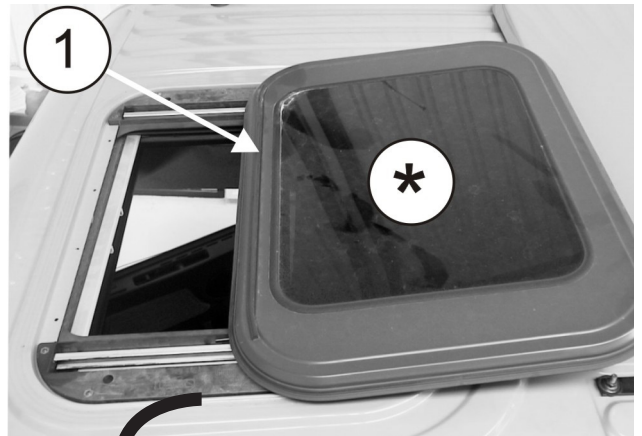

2 Stick on EPDM seal of 30x25mm, around the cut or the existing hatch gap



 **HOW TO CUT EPDM GASKET TO AVOID WATER FILTRATION INTO THE CABIN**

A- Glue gasket, keeping 100 mm of protection paper at each side.

B- Remove the two pieces of paper.

C- Glue by pressing both ends.

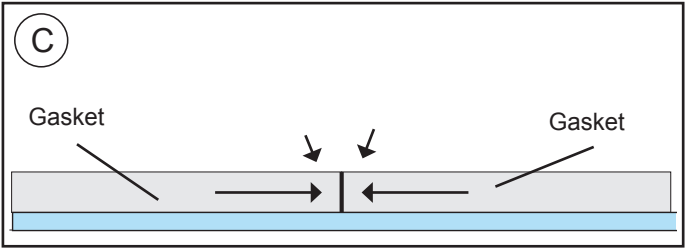
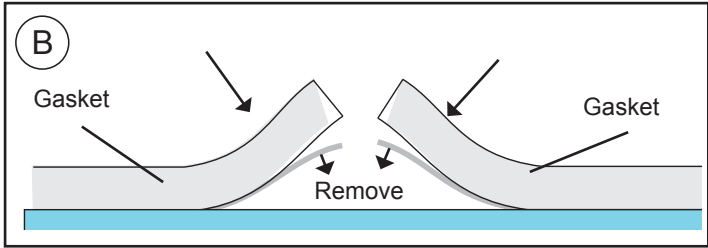
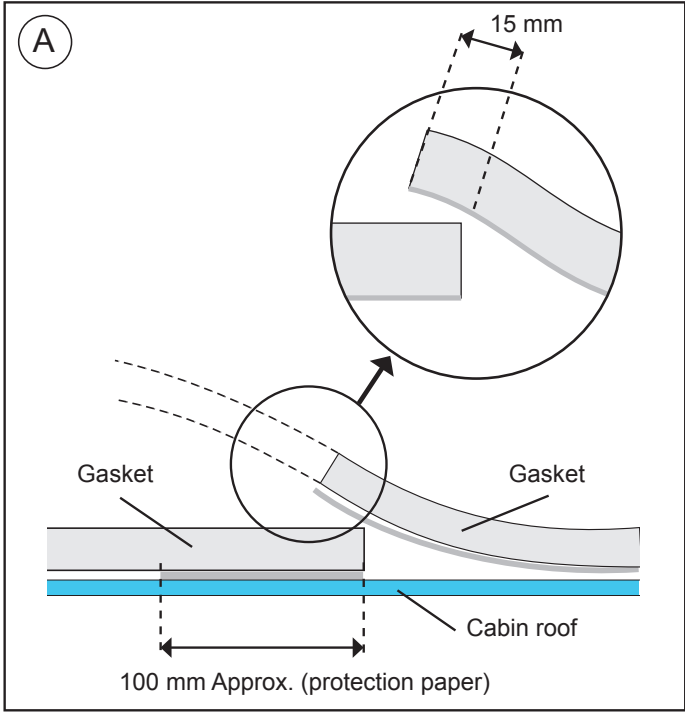

3 CABIN EXTERIOR:

Position the Compact in the gap.

Caution! When positioning the unit above the hatch gap, check that the wastewater run-offs are not blocked by the EPDM seal.

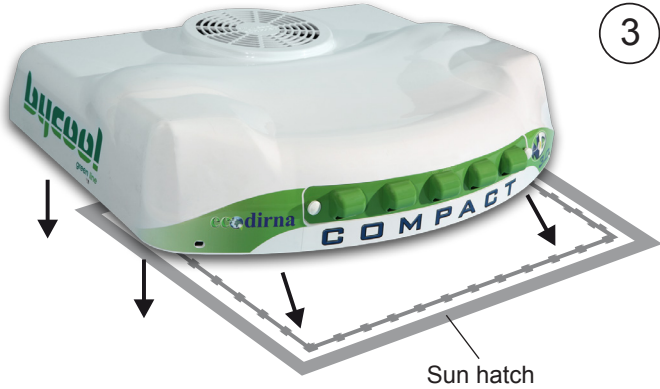

4 Colocar canalizador gomaespuma quedando la parte más blanda en la base del equipo.

Atención: Dependiendo de la cabina, es posible que sea necesario usar los (2) canalizadores suministrados para que el panel de distribución de aire quede totalmente ajustado con ellos.



5 **INSIDE CABIN:**

Screw about 5 mm (4) 8/125x70,100 or 120 mm studs, the exact measure is chosen after the fastening supports have been presented and taking into account that studs must stick out of lower part about 20 mm.

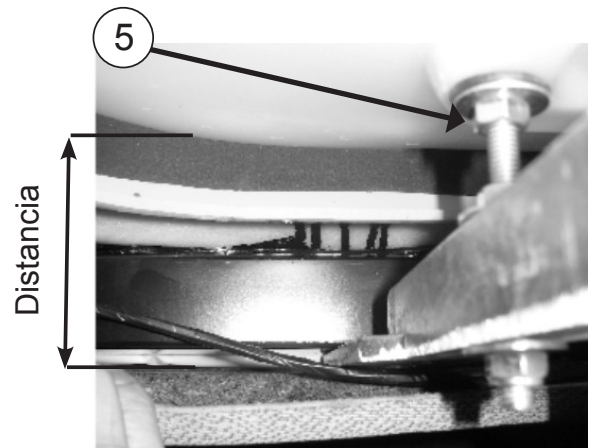
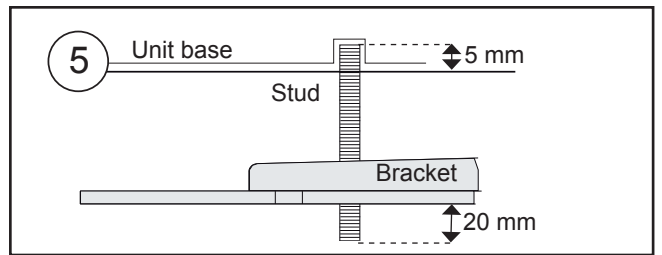

6 Following this order:

- plane rubber wash
- plane rubber wash wide wing diameter 8
- nut M8
- plane washer diameter 8 wide wing

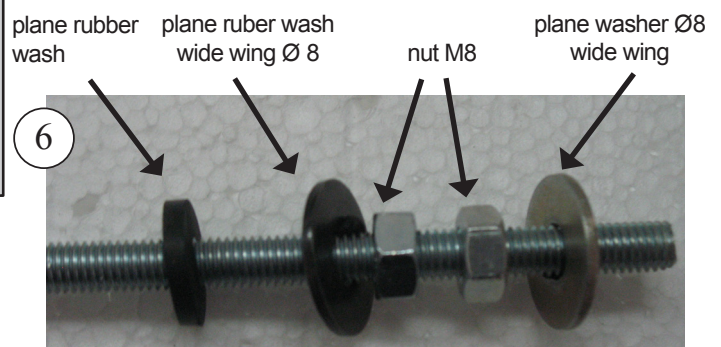

7 Place (2) fastening supports, with (1) washer and (1) M8 self-blocking nut, **without tightening**.

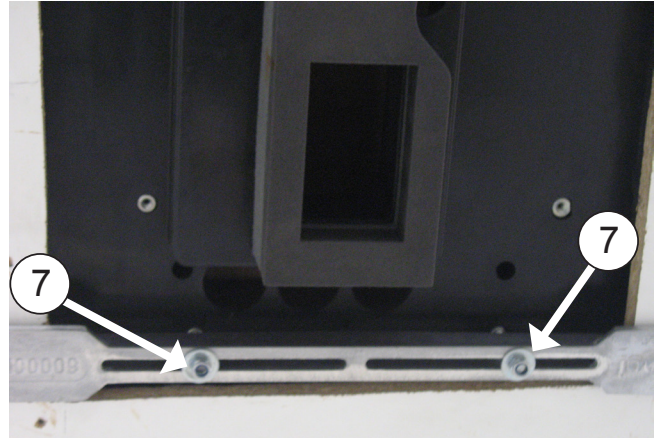

8 Screw 10 mm deep (4) M6 studs, where indicated distance (D) in figure point 10.

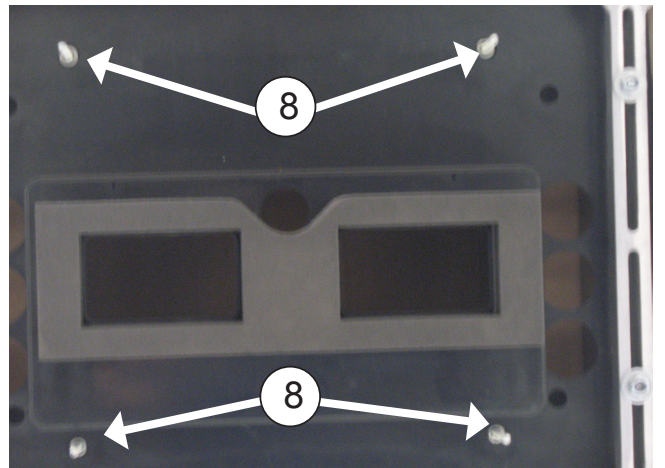
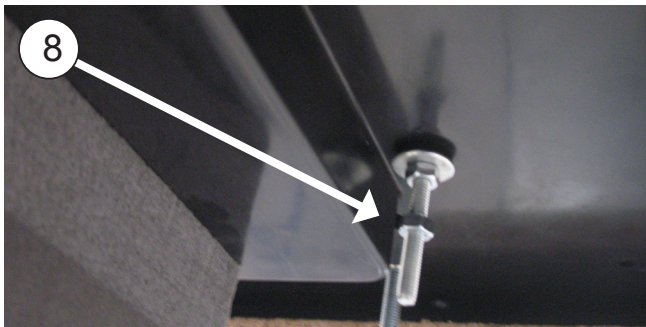

9 To place (1) rubber washer diameter 6 (1), plane washer diameter 6 wide wing and (1) nut M6, over each of the spigots of M6. After, to tight the nut til the rubber washer remain a little tight.

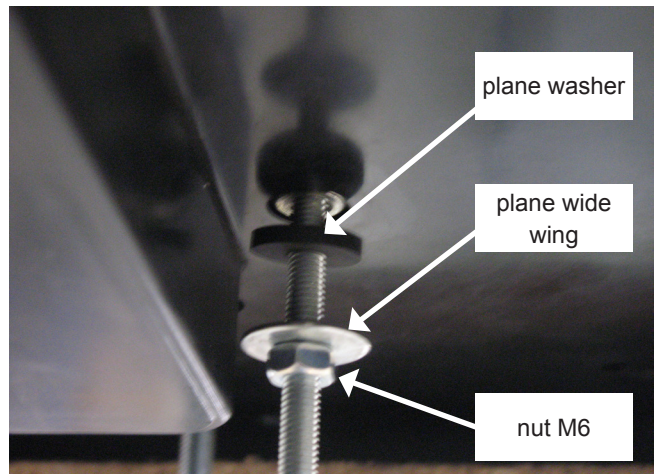

9a Place (2) fastening supports, with (1) washer and (1) M6 nut, **without tightening**.

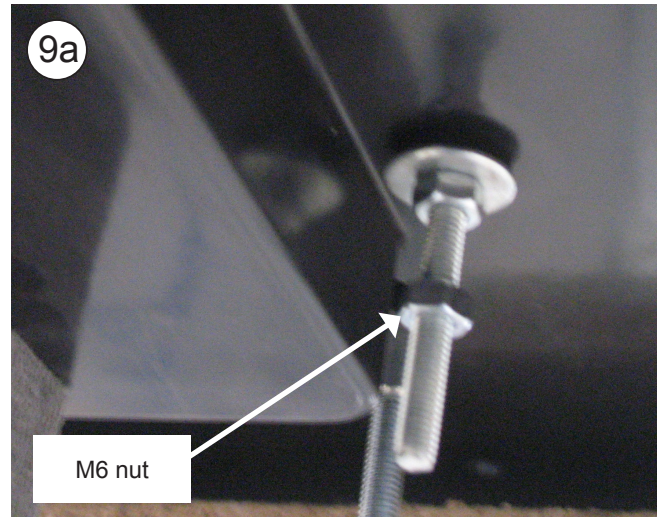

9b Between the base and the interior air distribution panel, connect (2) two-way boxes of the anti-freeze sensor (white cables) and the return air sensor (black cables), 4-way box of the blower, (2) communication cables and 8-way box of the electronic control connection cables.

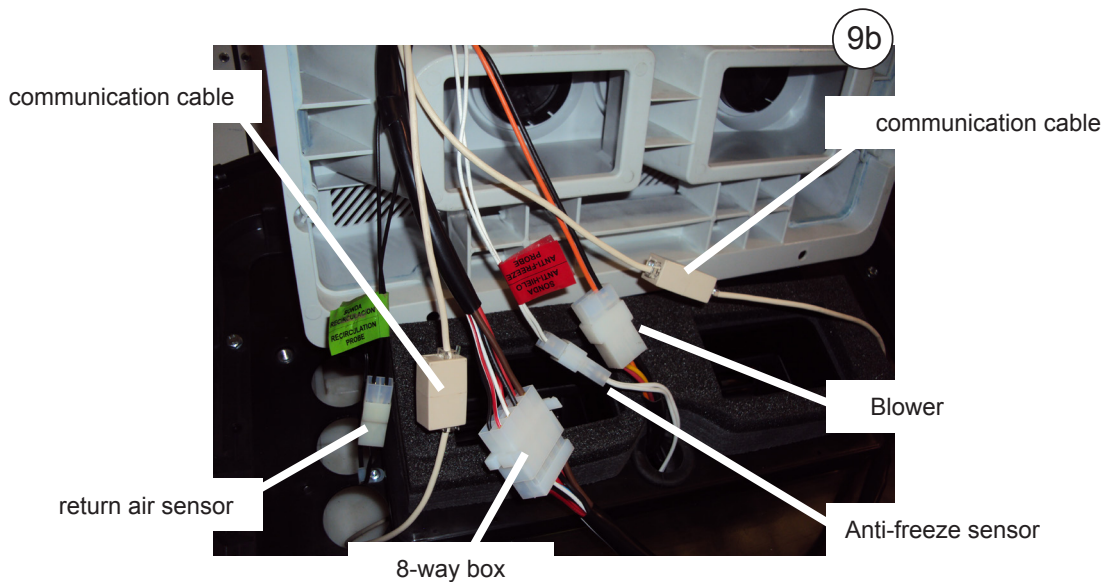

10 Position the air distribution panel on the front studs with (1) M6 wide-rim washer and (1) M6 nut on each stud. Tighten the nuts until the air distribution panel duct comes up against the air duct top side in the unit.

Important: The foam duct must come up against the upper foam in the unit in order to prevent any leakages of air.

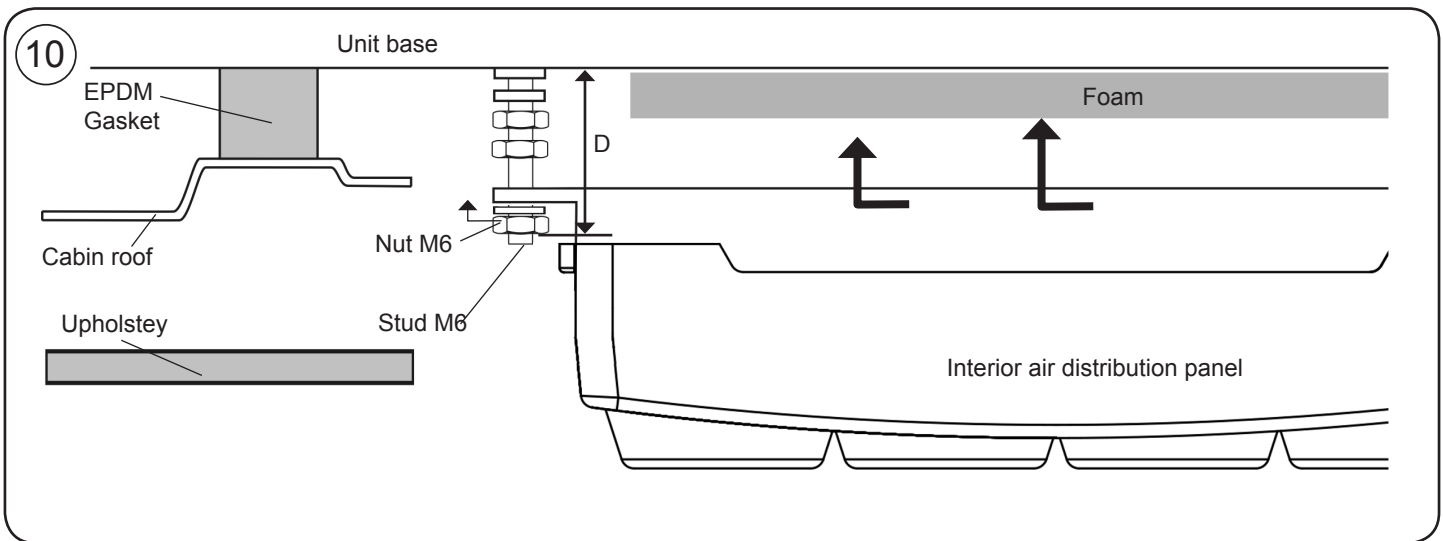
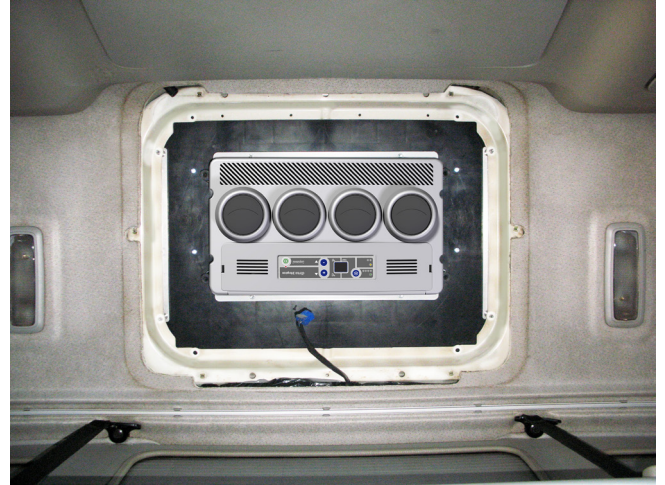

11 Tighten the nut in point **9a** until it comes up against the top part of the interior air distribution panel.

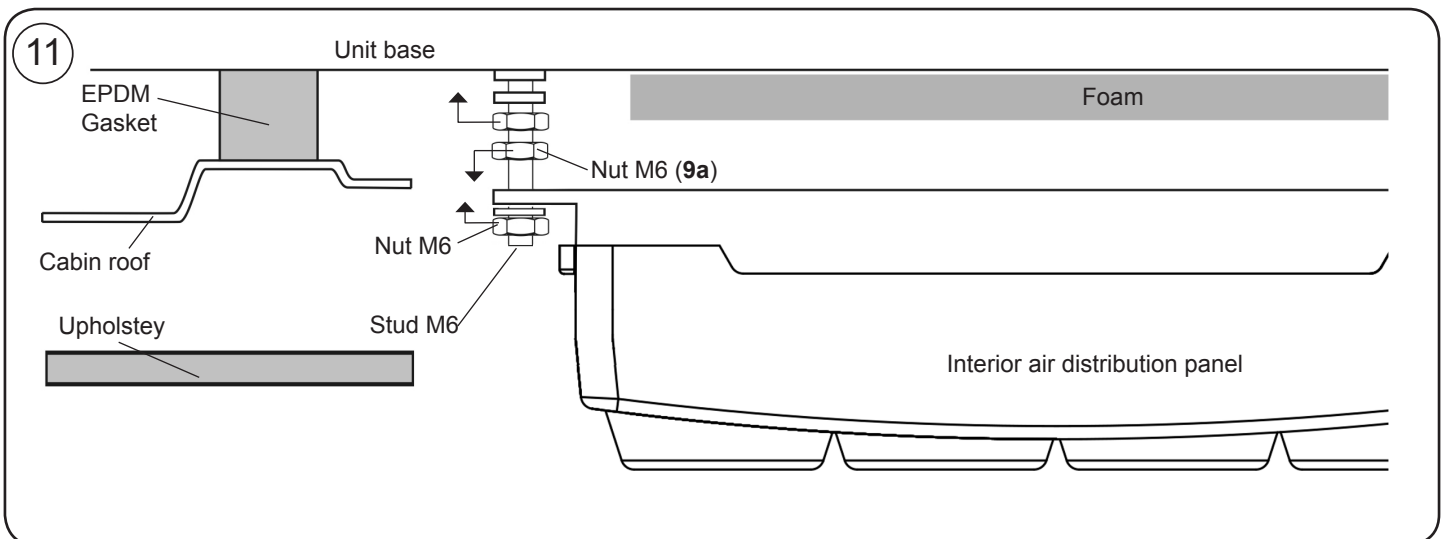

12 Position the console using the screws and align the unit in the most ideal position, ensuring the original screws are in position.



13 Fasten supports tightening nuts until outside EPDM joint of equipment is compressed, between 3 and 6 mm.

Important: To avoid water from filtering inside cabin, check EPDM joint tightening with Compact base, as indicated on **diagram**.

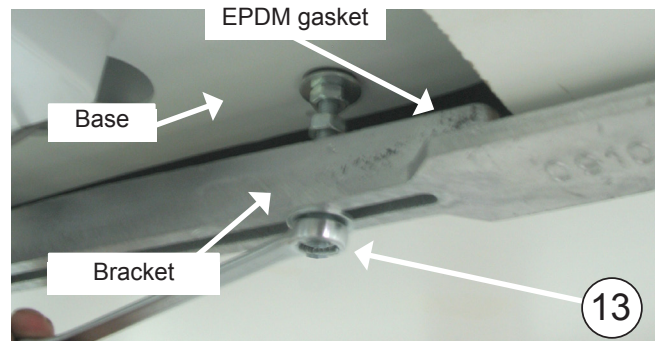
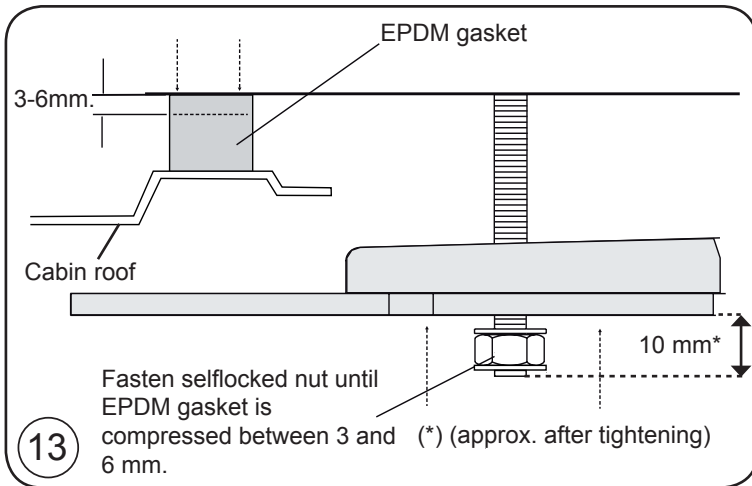

14 Tighten (4) M8 nuts to support and (4) to Unit base.

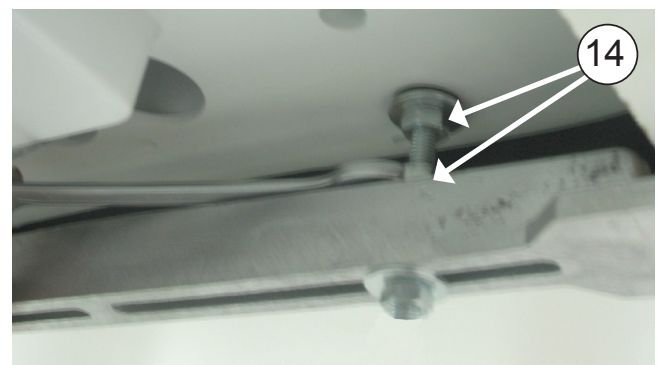

15

To place the frame with (4) original screw.



Exploded side view to supports fastening

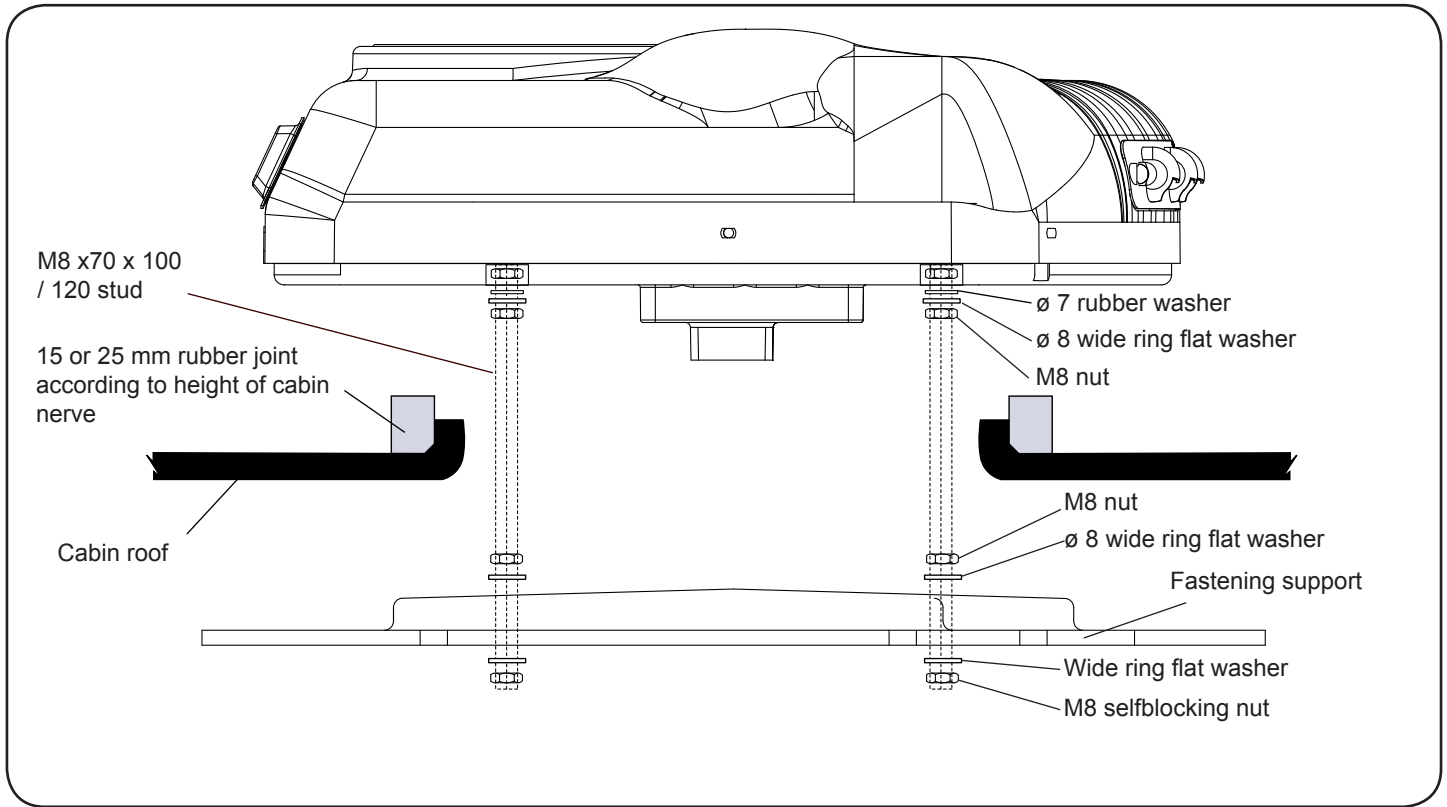

Exploded rear view to consoles fastening

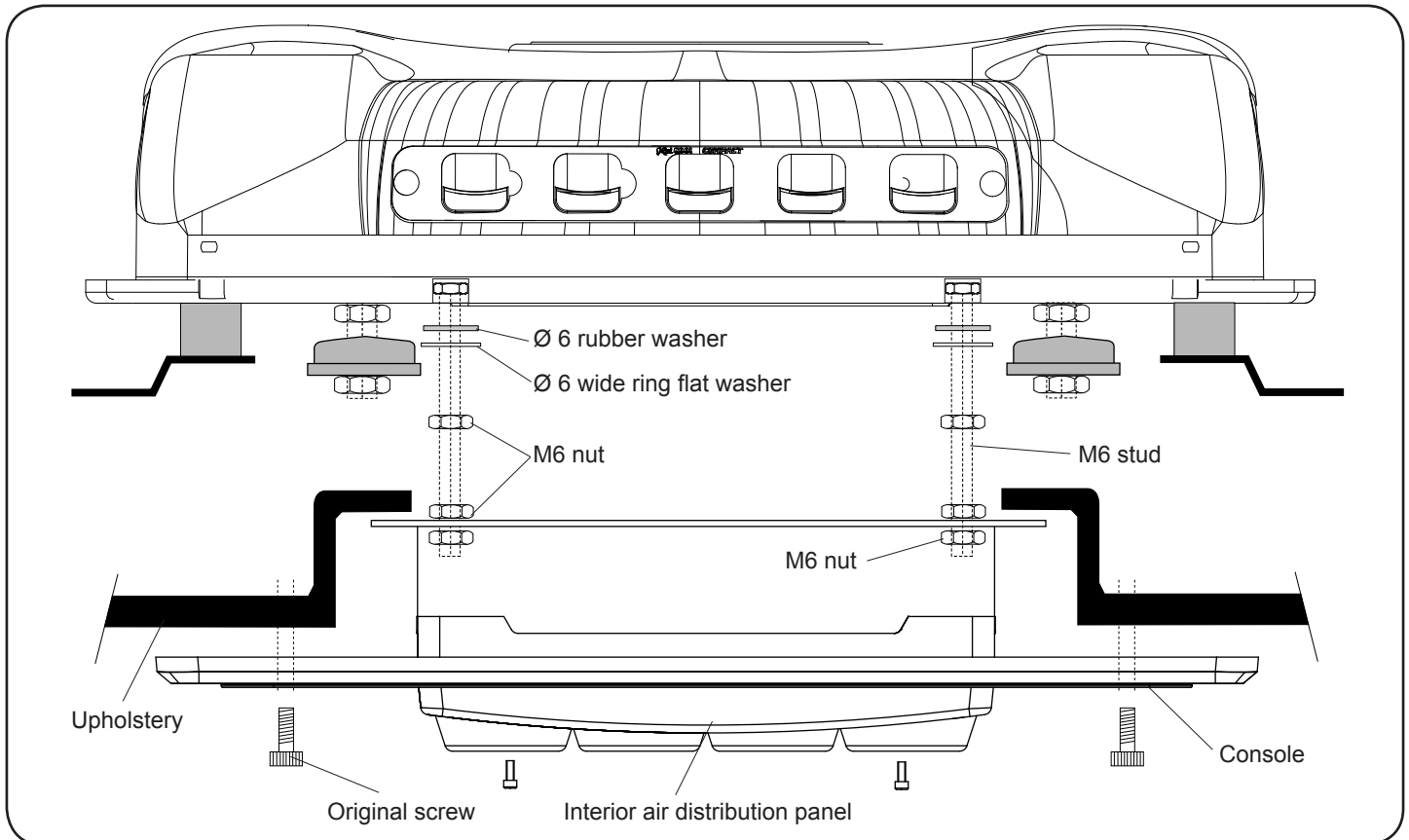

Detailed instructions on the installation of power supply cables

1 Connect the power cable to the unit's cable clamp and pass the cabling behind the input pipe.

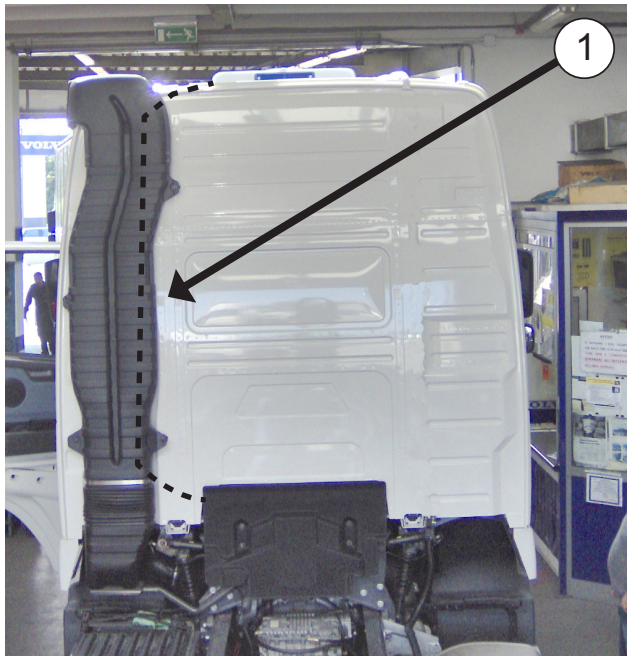
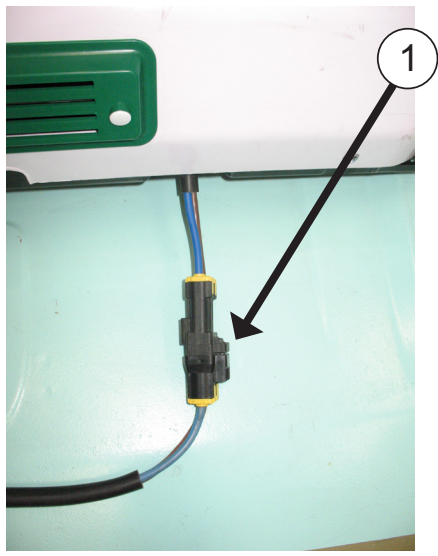

2 Take down the cabin and pass the cable through the indicated place to the positive connection point on the front of the cabin.

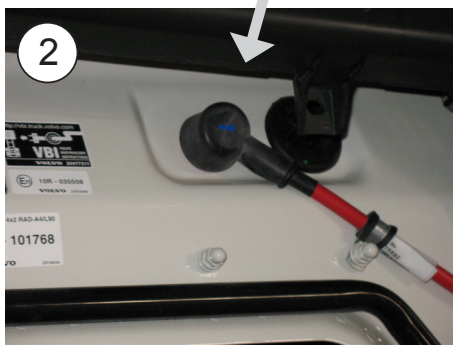
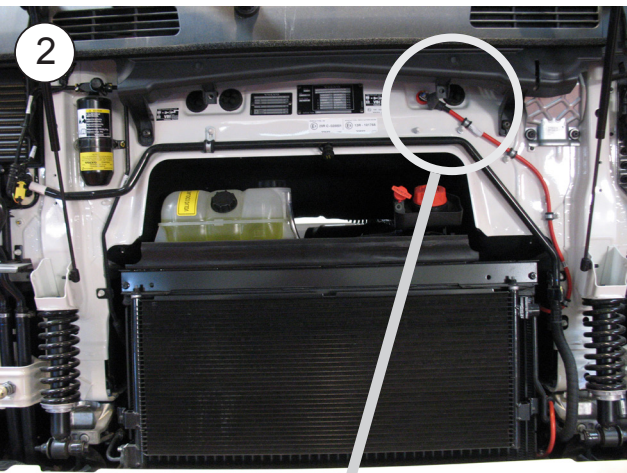
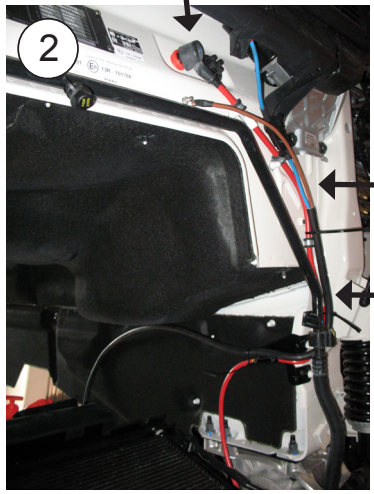
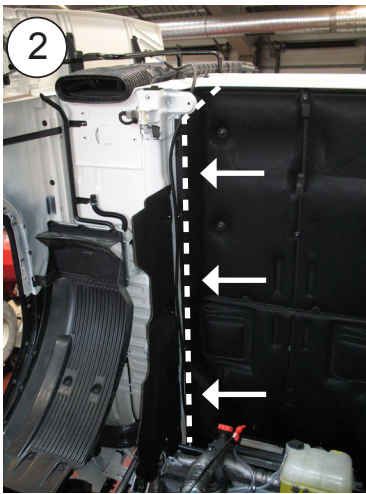

3 Remove the M6 nut and the M8 connection nut (+), and connect the power cable as indicated.

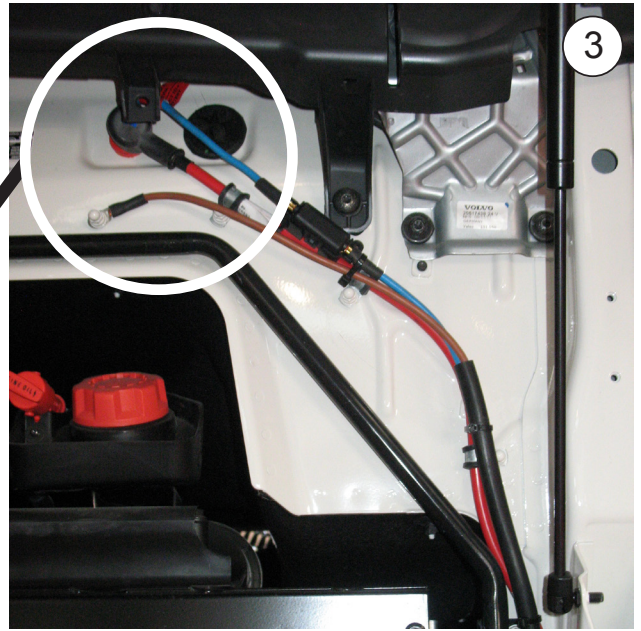
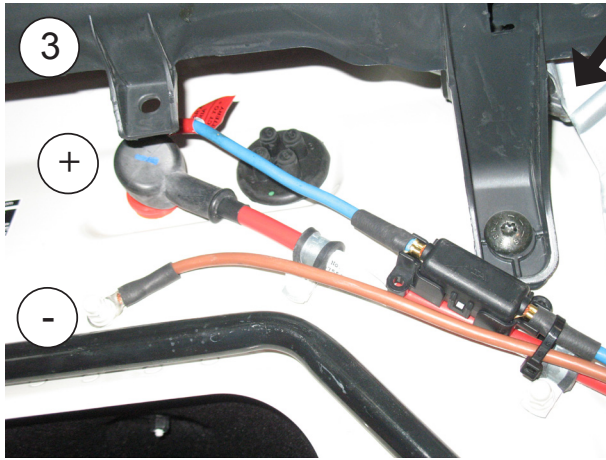

4 Secure the cabling to the original cable with flanges.

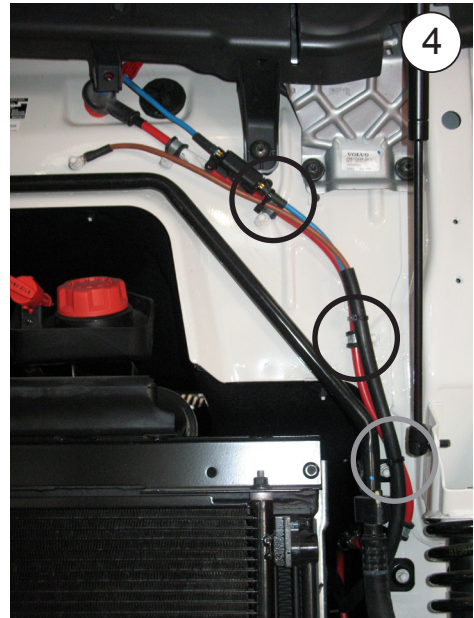

5 In the lower section, secure to the original studs with fasteners.



6 Take down the cabin and leave it in on position, placing any excess cabling behind the input pipe.



Electric wiring

IMPORTANT WARNING!

Take care not to invert polarities when connecting the unit to the power supply. If this were to happen, the unit will not work and irreparable damage will be caused to the compressor modules.

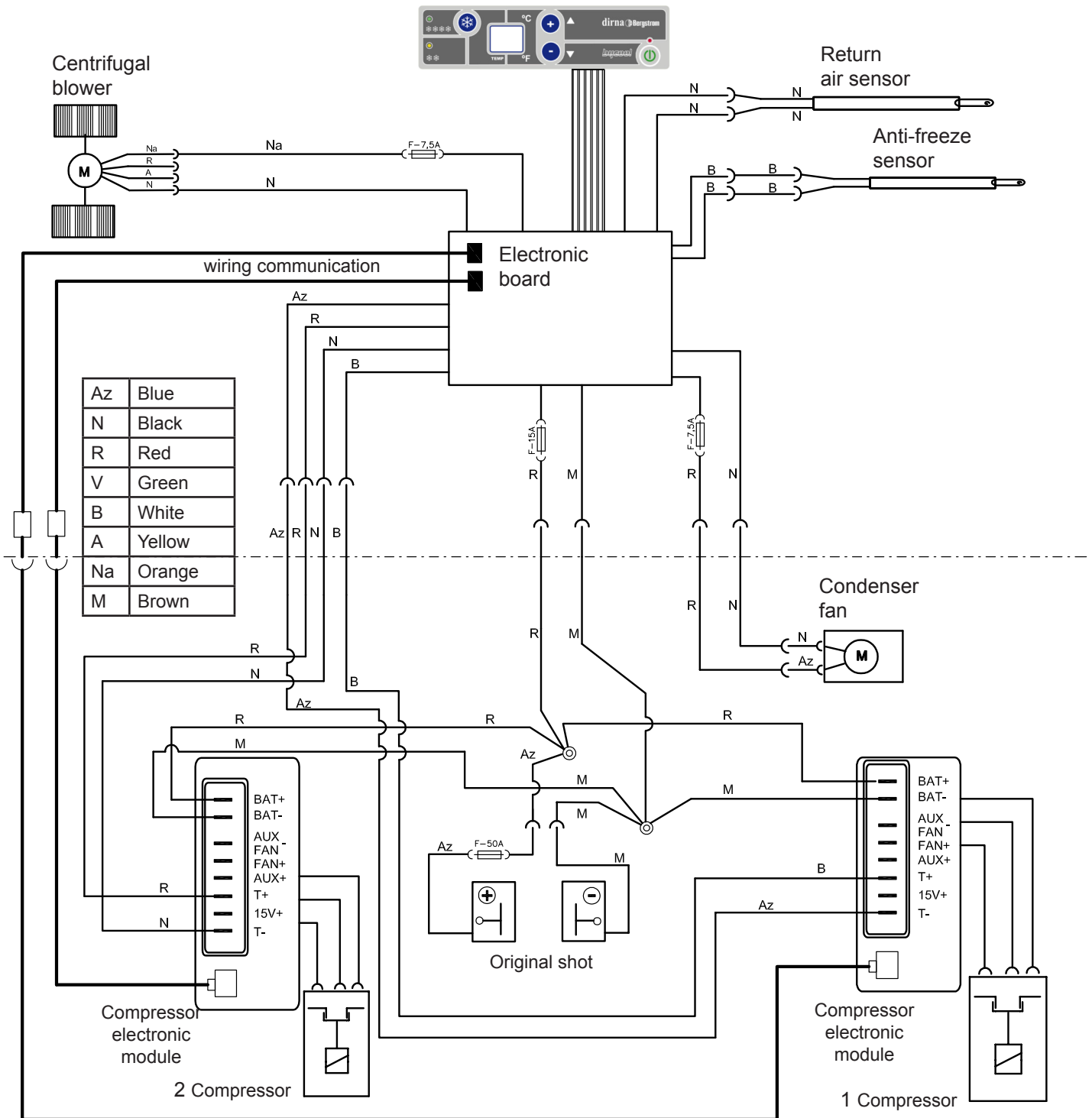

Recommandations Pour Le Montage

- Avant de commencer le montage de l'appareil, prière de lire les instructions et de les suivre attentivement.
- Utiliser les outils convenant à chaque opération.

Electricity

- Déconnecter la clé de contact.
- Déconnecter la batterie avant de commencer le montage.
- Vérifier le câblage des composants électriques et leur correcte installation.

Attention

Si pendant le montage l'équipement est incliné, il faudra attendre au moins 60 minutes avant de le mettre en marche une fois qu'il aura été remis sur sa position horizontale.

Attention

Lors de l'installation de l'appareil d'air conditionné sur le toit, il faudra protéger la partie supérieure de la cabine avec un linge ou une couverture de protection afin d'éviter les éventuelles égratignures.

Durant l'installation du **Compact**, tenir compte du fait que normalement les cabines pourvues d'écoutille possède une structure suffisamment solide pour supporter le poids de l'appareil. Cependant, si ce n'est pas le cas et qu'il est nécessaire de découper le toit ou même si disposant d'écoutille, la structure n'est pas suffisamment rigide (si elle était en fibre, plastique, etc.) il appartiendra à l'installateur de décider s'il faut renforcer le toit pour éviter toute déformation, rupture ou voie d'eau, etc., et prendre les mesures nécessaires à cet effet.

Outils

Jeu de clés Torx
 Jeu de clés Allen
 Clé fixe 10, 13, 14
 Ciseaux
 Mètre

Documentation included

Instructions de montage	1001217164
Guide de l'utilisateur	1001218019
Solution des problèmes	1001218025
Garantie	220AA10017

Symbologie



Fragile



Attention aux coupures !



Risque électrique

Garantie



L'installateur devra posséder la formation pertinente en air conditionné sur véhicules.



dirna Bergstrom, s.l., ne sera pas responsable des dommages ou des bris dérivés d'une installation ou d'une manipulation incorrecte ni des modifications réalisées sans autorisation expresse par écrit.



Appareil pré-chargé de gaz réfrigérant. (Ne pas manipuler le circuit de gaz réfrigérant).



Voir la **procédure de garantie** du produit au **Diagnostic de problèmes**.



Voir le **Guide de l'Usager** de l'appareil pour le fonctionnement correcte de la télécommande et du tableau de commande.



Après l'installation, vous devez fournir à l'utilisateur: Manuel d'utilisation, garantie et diagnostic de pannes.

 Avant de commencer le montage, monter la grille d'entrée d'air frontale.



1 Démontez le couvercle écoutille, cadre intérieur et remettez au clien.

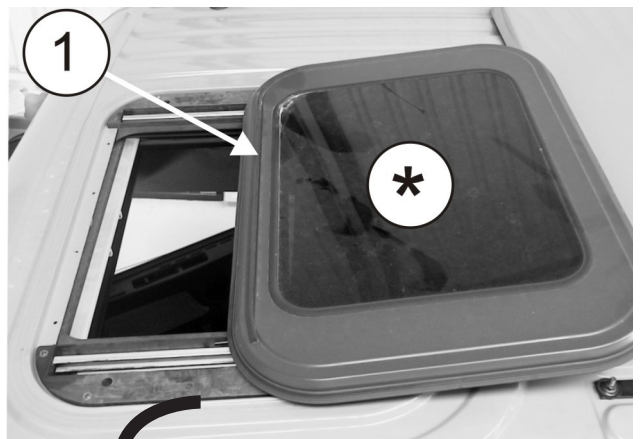

2 Collez le joint EPDM de 30x25mm, autour de la coupure ou du creux de l'écoutille.





COMMENT COUPER LE JOINT EPDM POUR EVITER LES FILTRATIONS DANS LA CABINE

- A- Coller le joint en maintenant une protection en papier de 100 mm de chaque côté.
- B- Retirer les deux morceaux de papier.
- C- Coller en faisant pression sur les deux extrémités.

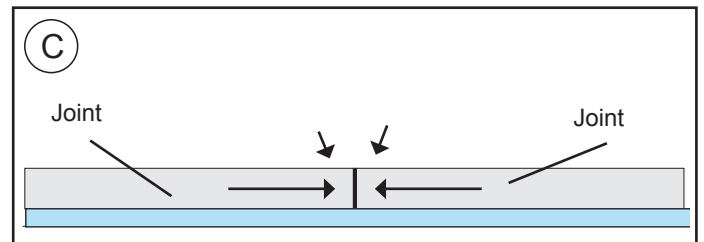
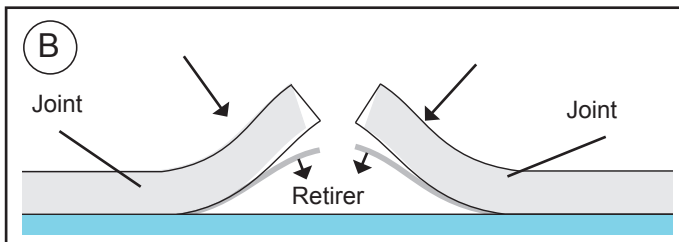
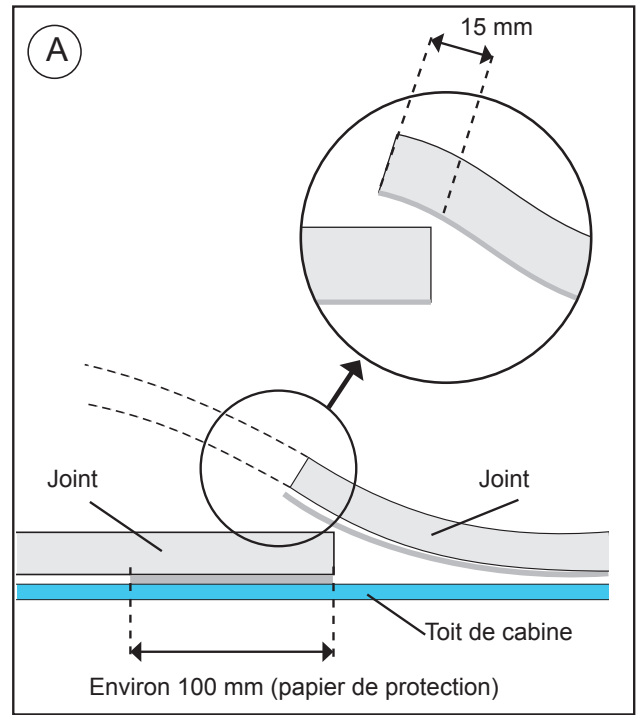

3

EXTÉRIEUR CABINE:

Placer le Compact dans le creux.

Attention ! Avant de placer l'équipement sur le creux de l'écouille, vérifier que les sorties d'écoulement ne soient pas bouchées par le joint EPDM.

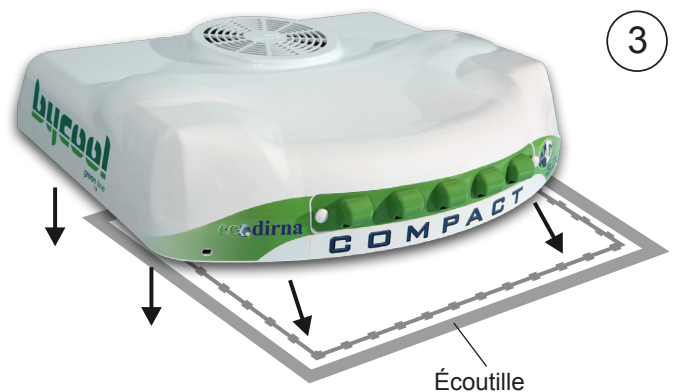

4 Placer le canalisateur en caoutchouc mousse en laissant la partie la plus molle sur la base de l'équipement.

Attention: en fonction de la cabine, il est possible de devoir utiliser les (2) canalisateurs fournis pour que le panneau de distribution d'air reste totalement ajusté avec ces derniers.



5 INTERIEUR CABINE:

Visser 5 mm environ (4) goujons de 8/125x70, 100 ou 120 mm, en fonction de la distance plus ou moins grande de l'appareil jusqu'à ce qu'en positionnant les supports de fixation, il ne reste que 20 mm au-dessous de ces supports.

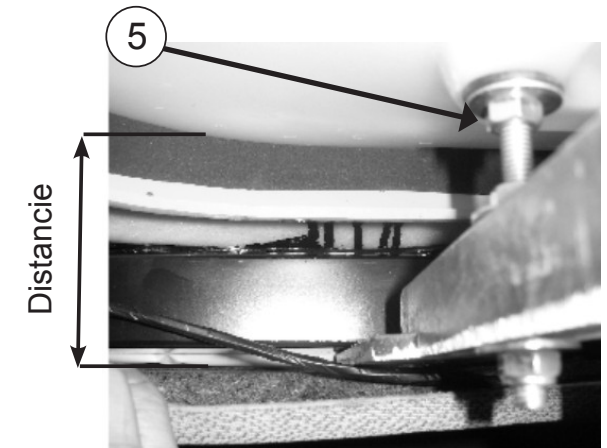
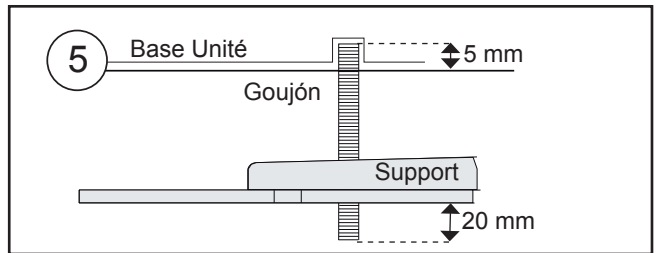

6 en suivant cet ordre :

- rondelle a mousse
- rondelle plain diamètre 8 aile large
- écrou M8
- plain rondelle diamètre 8 aile large

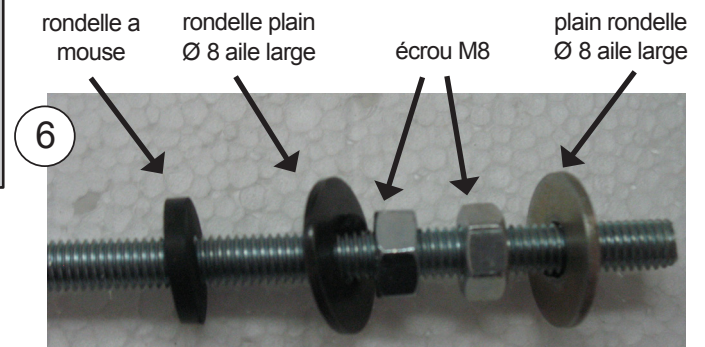

7

Placer les supports de fixation (2), avec une rondelle (1) et un écrou autobloquant (1) M8, sans serrer.

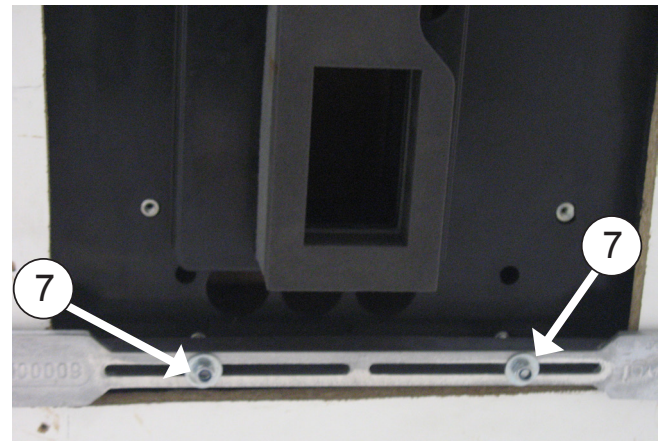

8

Visser 10 mm les goujons (4) M6 x 80, comme indiqué au (D) du schéma point 10.

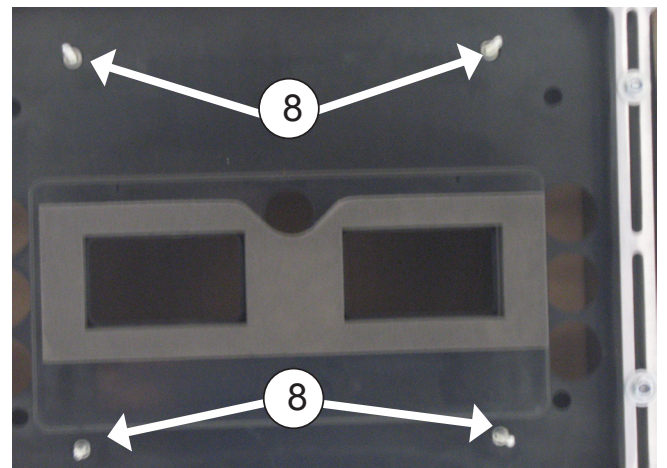
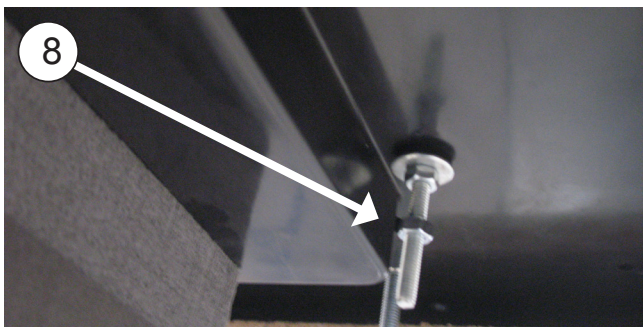

9

Placer (1) rondelle mousse diamètre 6 (1) plain rondelle diamètre 6 aile large et (1) écrou M6 sur chacun des asperges M6. En suivant serrer l'écrou jusqu'à la rondelle à mousse reste un peu pressée.

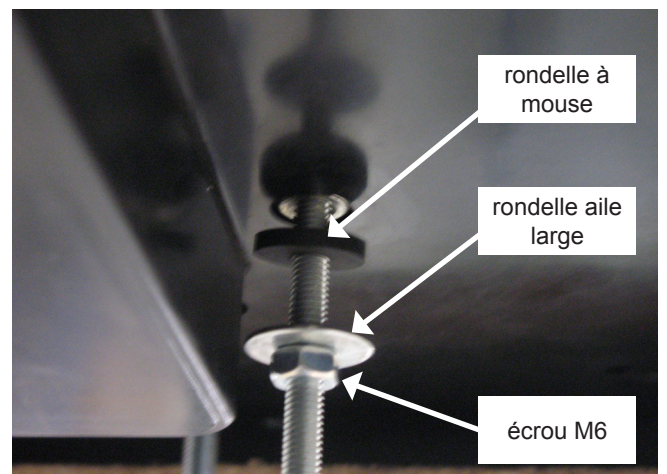

9a Placer l'écrou (1) M6 sans le serrer sur chaque goujon.

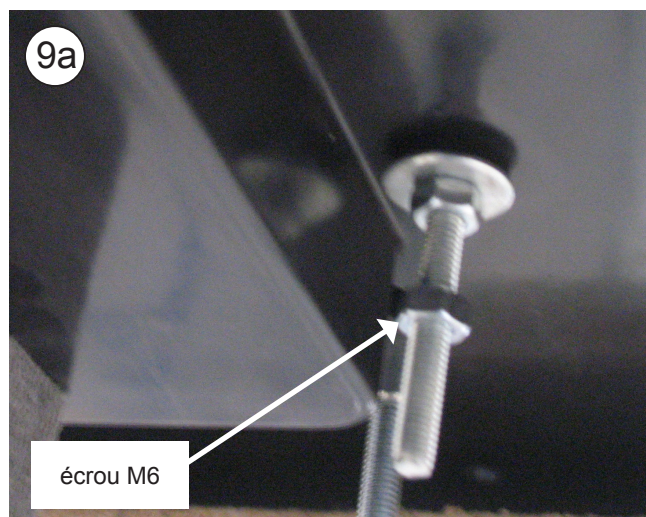

9b Entre la base et le panneau inférieur de distribution d'air, connecter (2) boîtes à deux voies de capteur antigel (câbles blancs) et capteur d'air de retour (câbles noirs), la boîte à 4 voies du souffleur, (2) câbles de communication et la boîte à 8 voies de câblage à la connexion avec contrôle électronique.

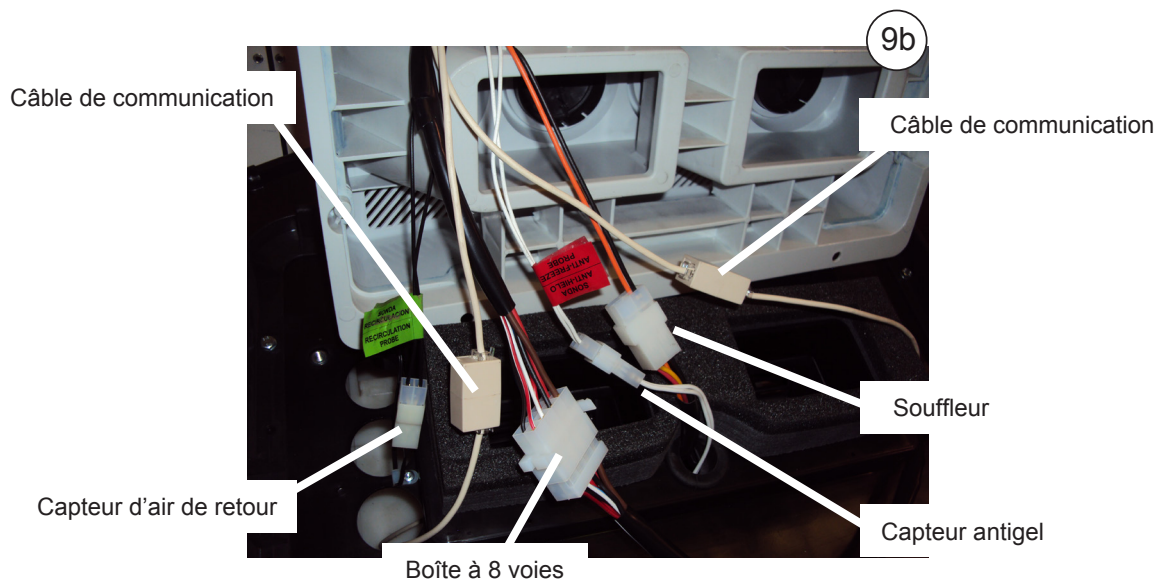

10

Placer le panneau de distribution d'air dans les goujons précédents avec (1) rondelle M6 surface large et (1) écrou M6 sur chaque goujon. Serrer les écrous jusqu'à ce que le canalisateur du panneau de distribution d'air heurte le couplage canalisateur de l'équipement.

Important : les canaliseurs en caoutchouc mousse doivent heurter le caoutchouc mousse supérieur de l'équipement pour éviter des fuites d'air.

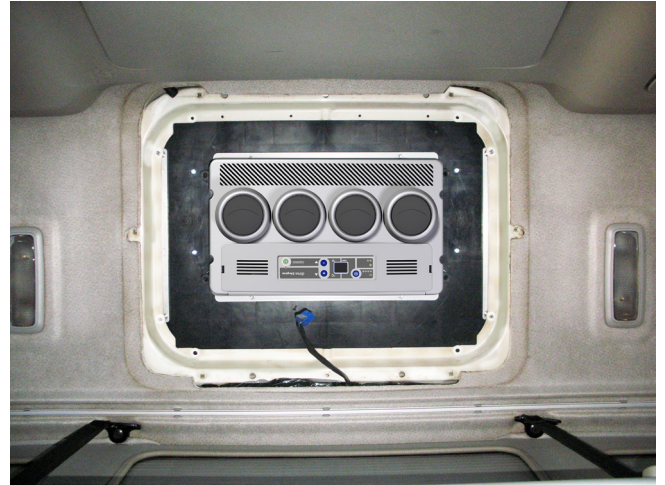

10

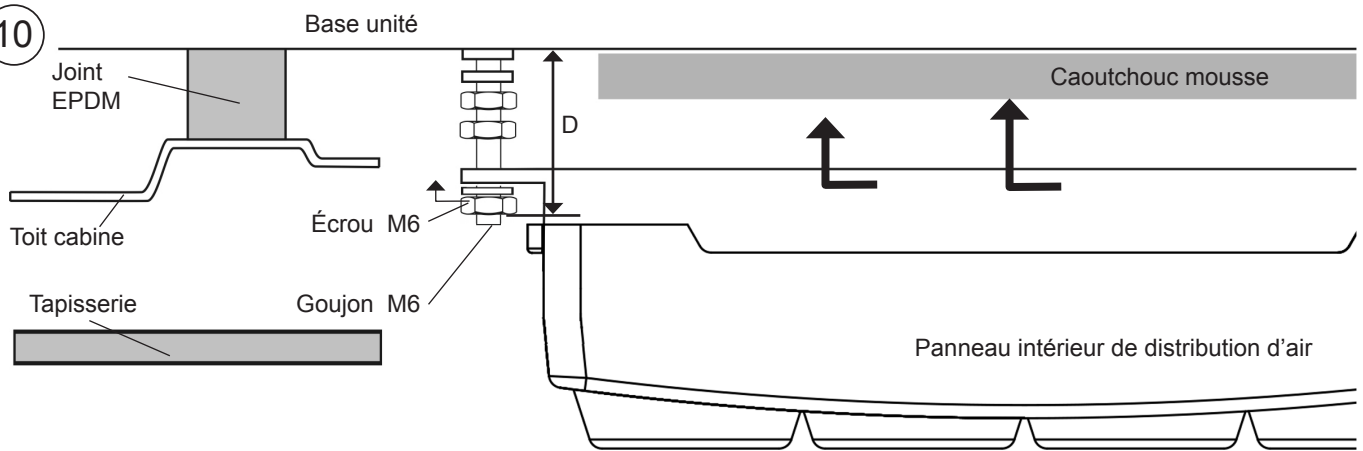

11

Serrer l'écrou du point 9a jusqu'à atteindre la partie supérieure du panneau intérieur de distribution d'air.

11

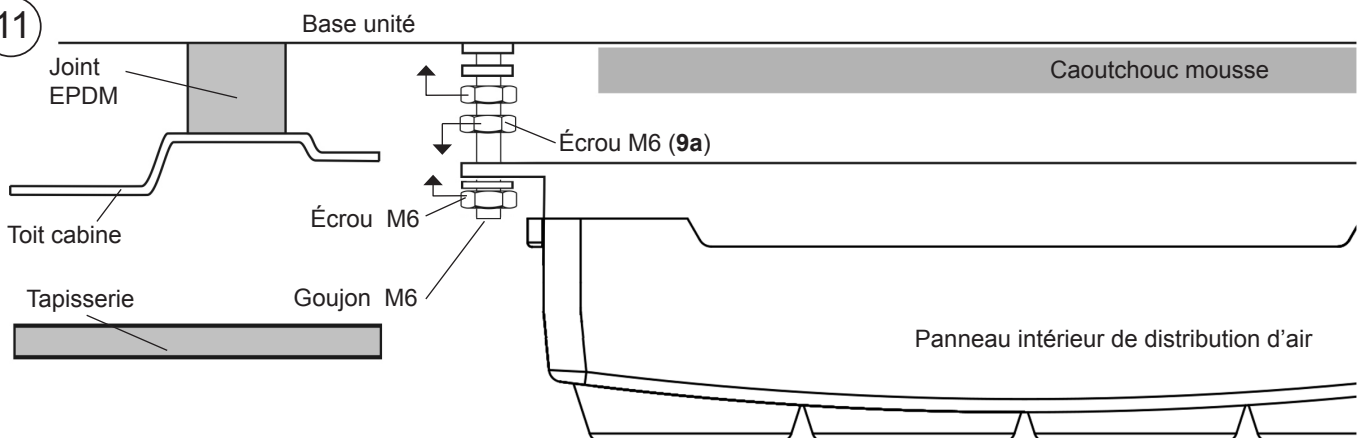

12 Présenter la console avec les vis d'origine et centrer l'équipement sur la position la mieux adaptée, jusqu'à ce que les vis d'origine coïncident dans leur emplacement.



13 Fixer les supports en serrant les écrous jusqu'à serrer le joint EPDM de l'appareil entre 3 et 6 mm.

Important: Pour éviter la filtration d'eau dans la cabine, vérifier le serrage du joint EPDM à la base du Compact, comme indiqué sur le diagramme.



Vérifier la compression du joint EPDM en utilisant un flexomètre dans les quatre coins.

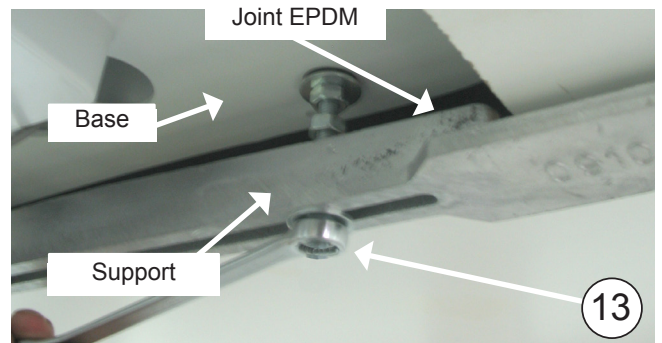
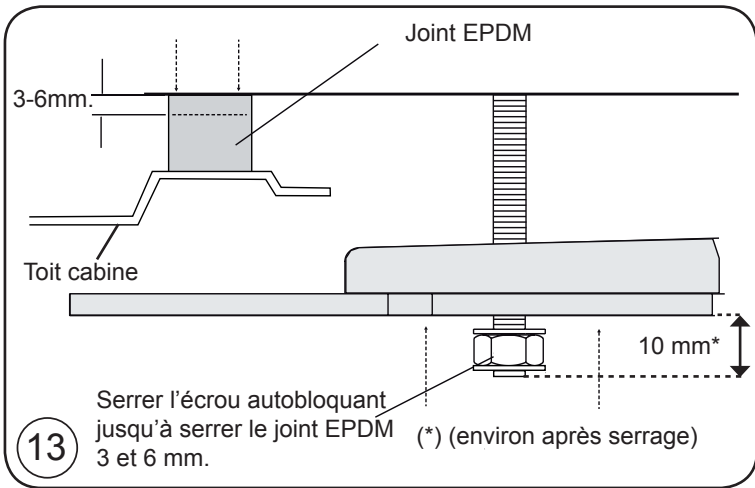

14 Serrer les écrous (4) M8 afin de fixer à (4) l'unité base.

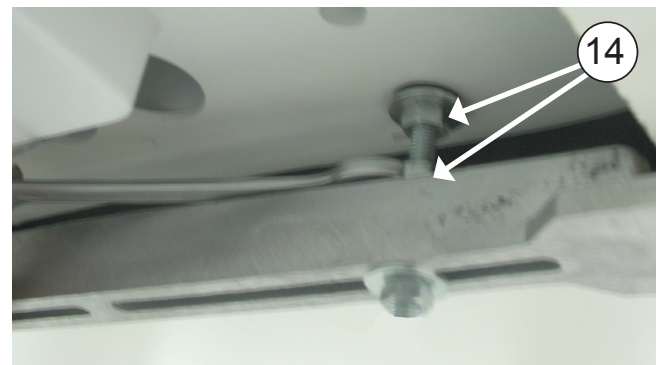

15

Placer la console avec (4) vis originales.



Vue explosée jusqu'à la fixation des supports de fixation

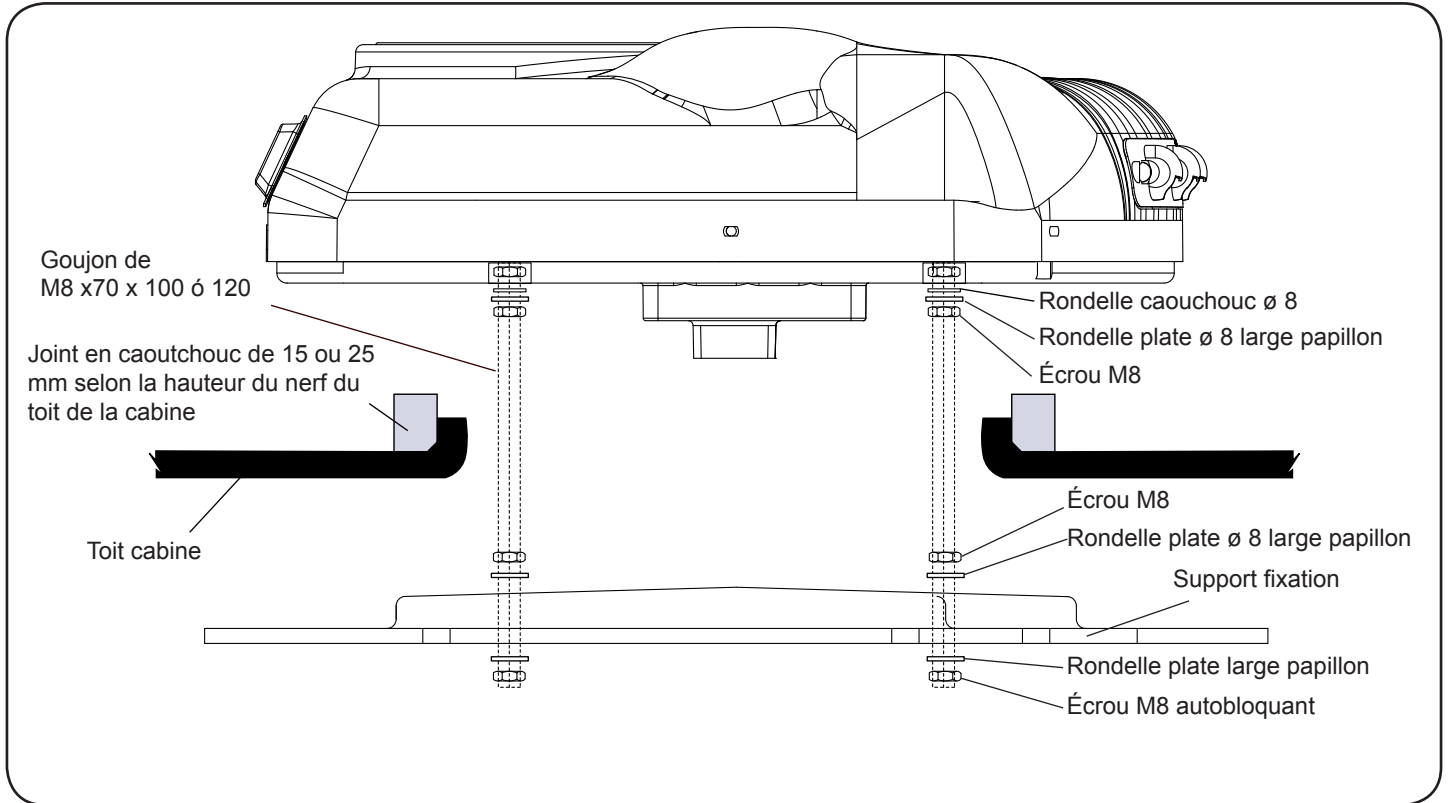

Vue explosée jusqu'à fixation des consoles

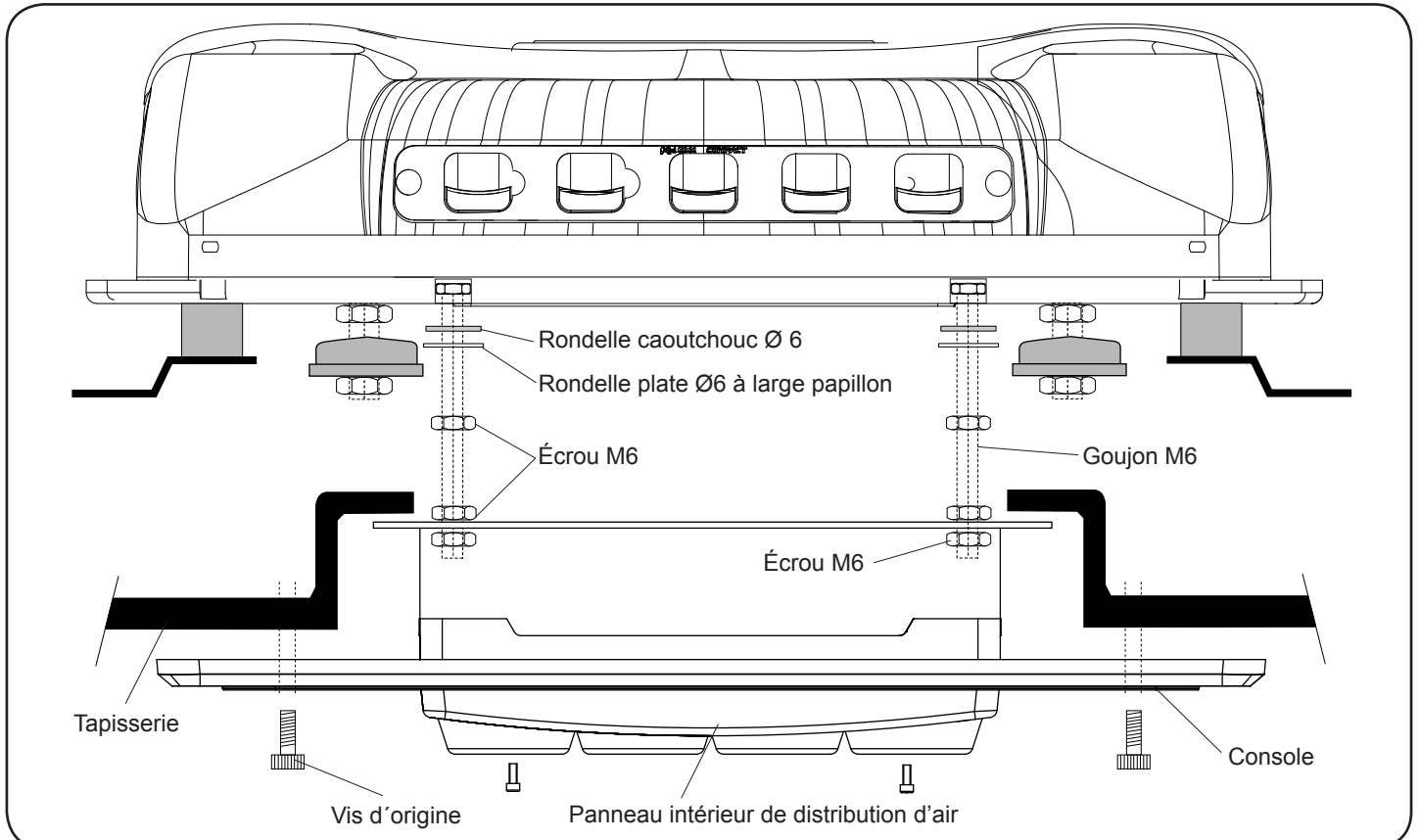

Instructions détaillées sur l'installation du câblage d'alimentation

1 Connecter la borne du câble d'alimentation à la borne de l'équipement et passer le câblage derrière le tuyau d'admission.

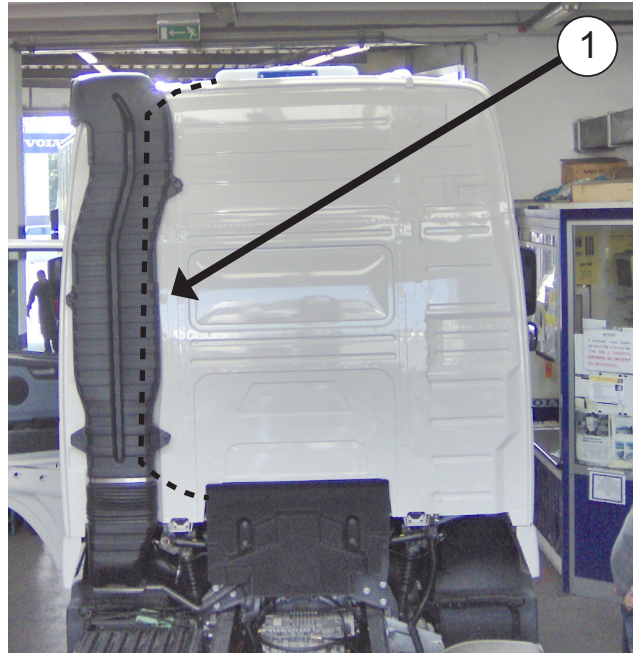
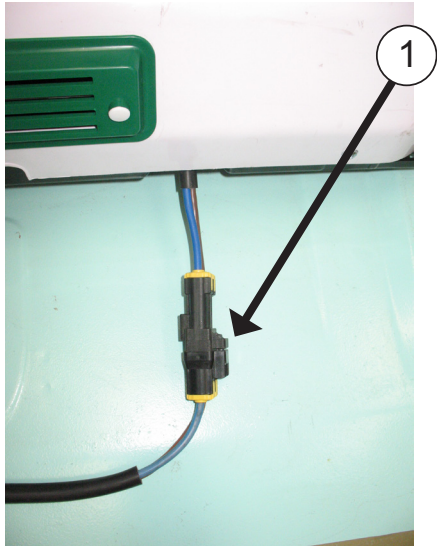

2 Incliner la cabine et mener le câble à travers le lieu indiqué jusqu'à la prise de positif située sur la partie avant de la cabine.

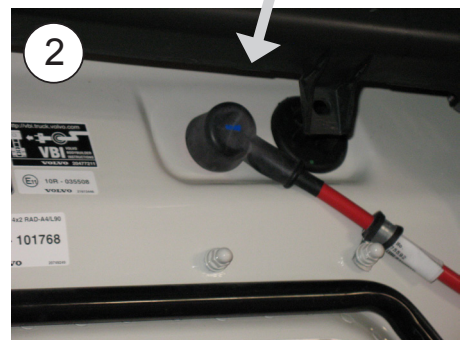
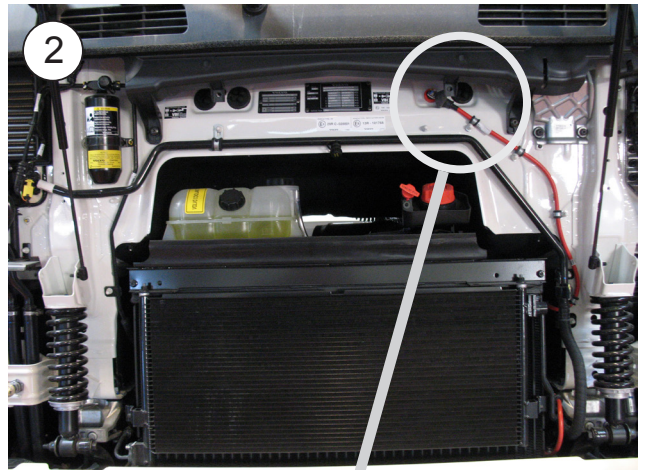
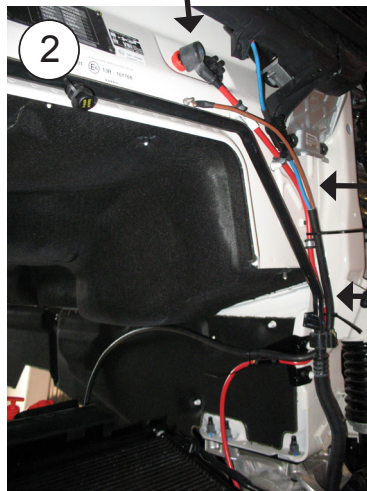
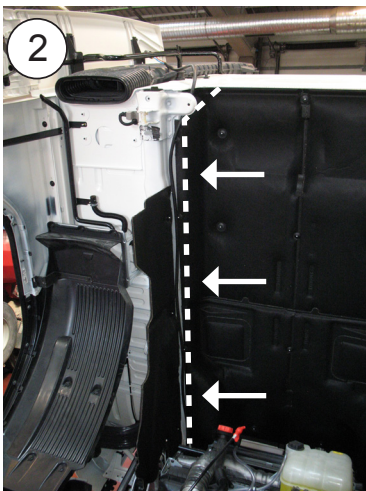

3 Démontez l'écrou M6 et l'écrou M8 de la prise (+) et connectez le câblage d'alimentation comme cela est indiqué.

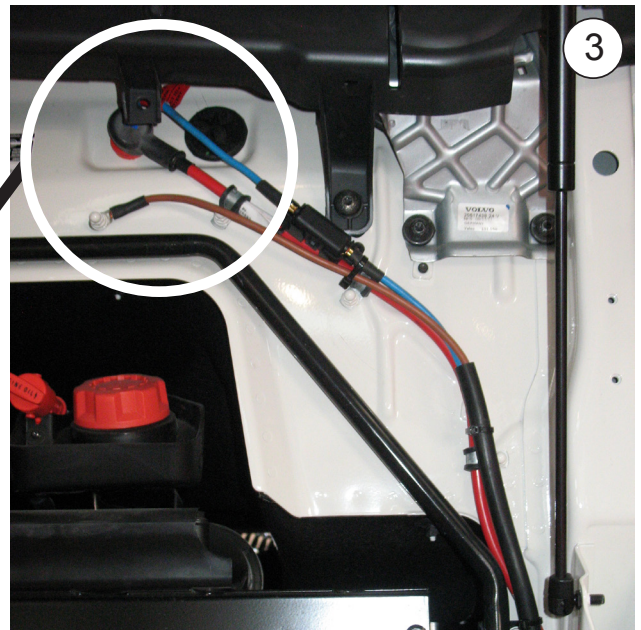
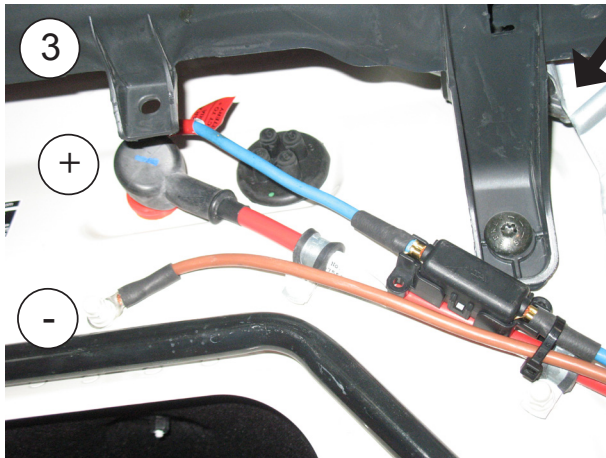
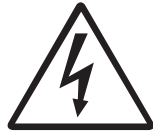

4 Fixer le câblage avec des brides au câble d'origine.



5 Sur la partie inférieure, fixer avec des colliers aux vis sans tête d'origine.

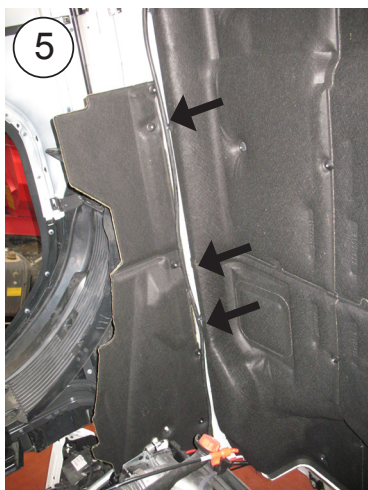

6 Incliner la cabine et laisser sur la position de marche. Placer le câblage restant derrière le tuyau d'admission.

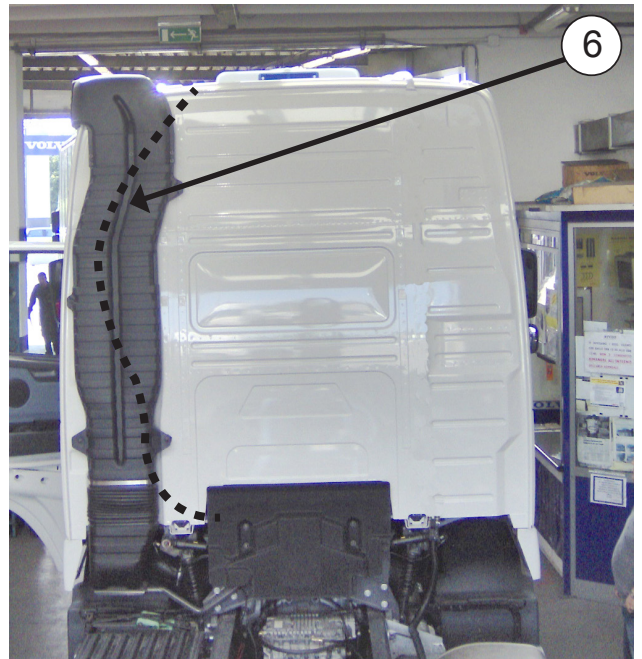

Câblage électrique

AVERTISSEMENT IMPORTANT!

Attention ! Ne pas inverser les polarités dans la connexion de l'alimentation à l'équipement. Si cela se produisait, la plaque ne s'allumerait pas, l'équipement ne fonctionnerait pas et des dommages irréparables se produiraient sur les modules des compresseurs.

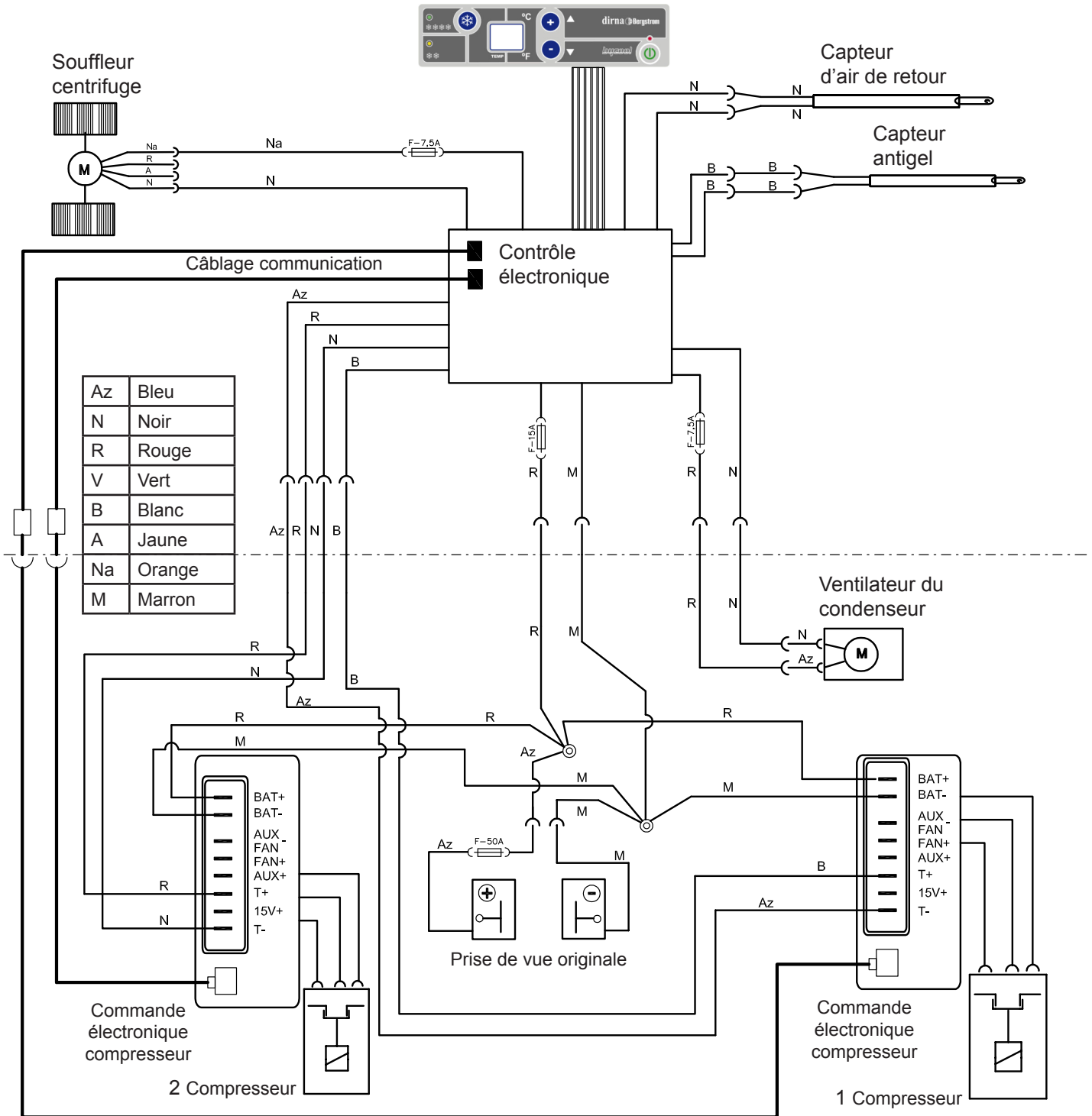

Empfehlungen Zur montage

- Vor und während der Montage bitte diese Anweisungen lesen und beachten.
- Benutzen Sie für jeden Arbeitsschritt die geeigneten Werkzeuge.

Elektrizität

- Zündschlüssel abziehen.
- Vor Montagebeginn die Batterie abklemmen.
- Den ordnungsgemäßen Anschluss und die korrekte Installation der Elektrokomponenten überprüfen.

Achtung

Sollte sich das Gerät während der Montage neigen, muss man mindestens 60 Minuten warten, nachdem es wieder in die horizontale Lage gebracht wurde, um es wieder einzuschalten.

Achtung

Wird die Klimaanlage im Kabinendach installiert, muss der obere Teil der Kabine mit einem Tuch oder einer Decke gegen eventuelle Kratzer geschützt werden. Bei der Installation der **Compact** auf dem Kabinendach muss darauf geachtet werden, dass mit Luken ausgestattete Kabinen über eine ausreichend stabile Struktur verfügen, um das Gewicht des Geräts stand zu halten. Sollte das Fahrzeug über keine Luke verfügen und sollte es notwendig sein, das Kabinendach aufzuschneiden, bzw. sollte die vorhandene Struktur nicht ausreichend stabil sein (z.B. wenn sie aus Faser, Kunststoff usw. hergestellt ist), obliegt es dem Installateur zu entscheiden, ob das Kabinendach zur Vermeidung von Verformungen, Brüchen, undichten Stellen usw. verstärkt werden muss, und die hierfür notwendigen Mittel bereit zu stellen.



Werkzeuge

- Torx-Schraubenschlüssel
- Inbusschraubenschlüssel
- 10er, 13er, 14er Schraubenschlüssel
- Schere
- Metermaß







Mitgelieferte unterlagen

Montageanweisungen	1001217164
Benutzerleitfaden	1001218019
Fehlerdiagnose	1001218025
Garantie	220AA10017

Symbologie

-  Fragile
-  Attention aux coupures !
-  Risque électrique

Warnhinweise

-  Der Installateur muss im Bereich Fahrzeug-Klimaanlagen ausreichend geschult sein.
-  **dirna Bergstrom, s.l.** übernimmt keine Verantwortung für Schäden oder Brüche aufgrund einer nicht ordnungsgemäßen Installation oder Bedienung des Geräts oder den Austausch von Teilen bzw. Umbauten, die ohne die erforderliche schriftliche Genehmigung durchgeführt wurden.
-  **Mit Kältemittel vorgefülltes Gerät. (Kältemittelkreislauf nicht manipulieren).**
-  Siehe **Garantieverfahren** des Produkts in der **Fehlerdiagnose**.
-  Siehe **Benutzerleitfaden** des Geräts für den ordnungsgemäßen Betrieb der Fernbedienung und des Bedienfelds.
-  Die folgenden Unterlagen müssen dem Benutzer nach der Installation ausgehändigt werden: **Benutzerleitfaden, Garantie und Fehlerdiagnose.**

 Vor Montabeginn vorderes Lufteintrittsgitter montieren.



1 Lukendeckel, Innenrahmen ausbauen und dem Kunden übergeben

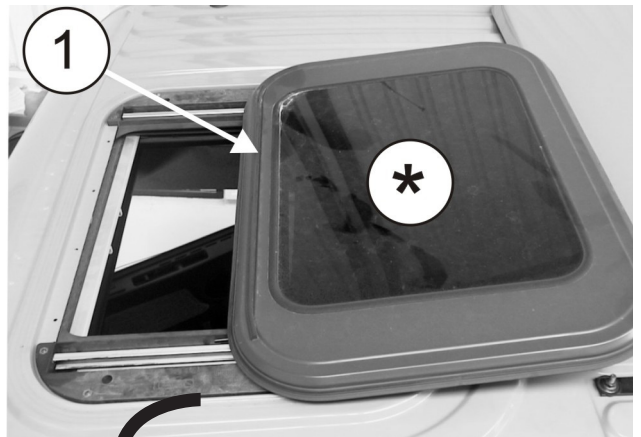

2 Dichtung EPDM 30x25mm um die eingeschnittene Öffnung oder die Lukenöffnung kleben.





WIE DIE EPDM-DICHTUNG GESCHNITTEN WIRD, UM FILTRATIONEN IN DER KABINE ZU VERMEIDEN

A- Dichtung aufkleben und dabei einen Papierschutz von 100 mm auf jeder Seite beibehalten.

B- Die zwei Papierstücke entfernen.

C- Unter Anpressen beider Enden aufkleben.

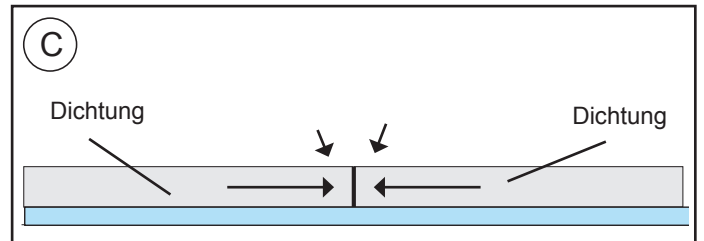
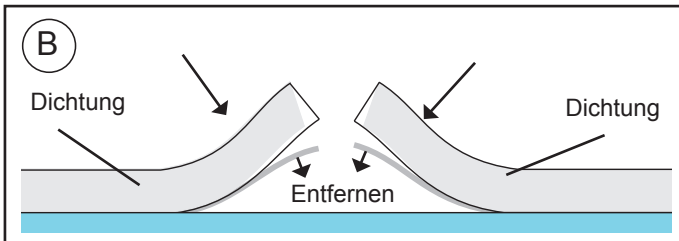
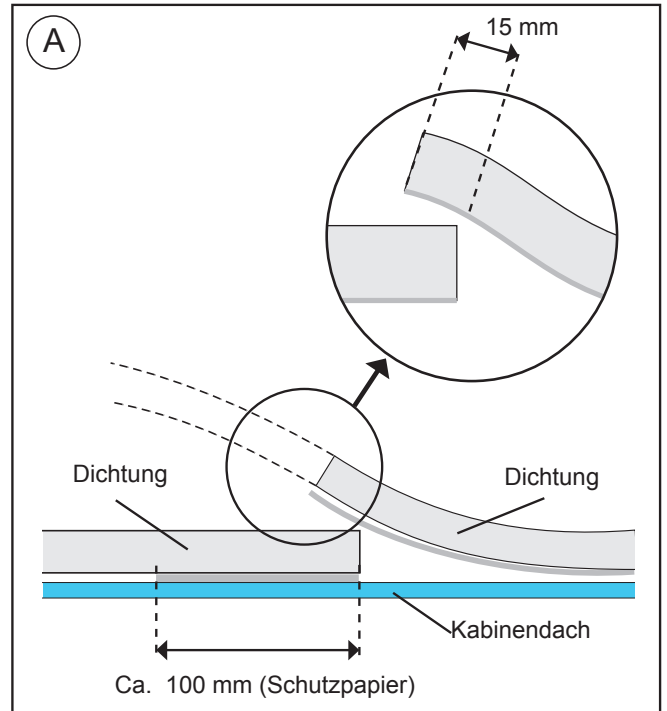

3

FAHRERHAUS AUSSEN:

Compact in der Öffnung positionieren.

Achtung! Beim Auflegen des Geräts auf die Lukenausparung darauf achten, dass die Ablassausgänge nicht von der EPDM-Dichtung zusammengedrückt werden.

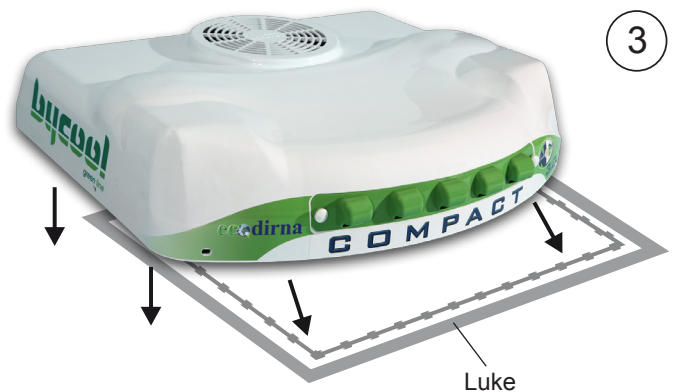

4 Schaumgummidurchführung anbringen, wobei der weichere Teil auf der Gerätegrundplatte aufliegt.

Achtung: Je nach Kabine kann es erforderlich sein, die (2) mitgelieferten Führungen zu verwenden, damit die Luftverteiltertafel ordnungsgemäß ausgerichtet ist.



5 KABINENINNENSEITE:

Ca. 5 mm Gewinde für (4) Stiftschrauben 8/125x70, 100 oder 120 mm schneiden (abhängig vom größeren oder kleineren Abstand vom Gerät bis sie nach Positionierung der Befestigungsauflagen 20 mm unter diesen liegen).

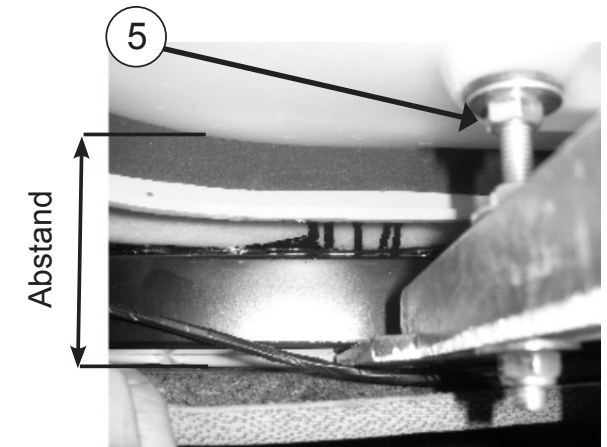
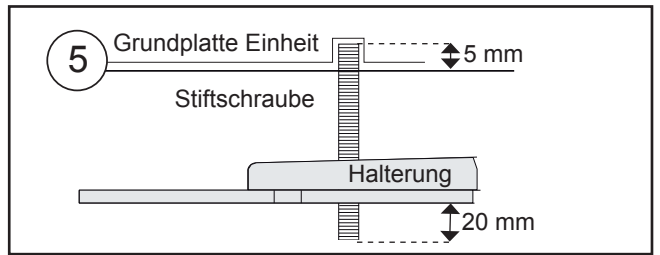

6 Montieren Sie wie folgt:
Gummischeibe / 3D Unterlegscheibe / Mutter / Gewindestange

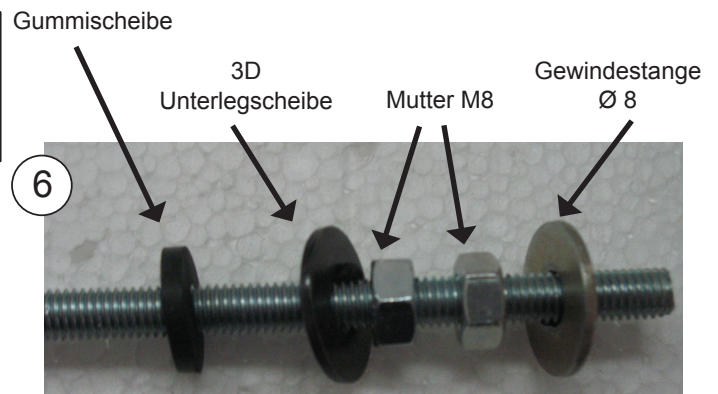

7 Befestigungsauflagen (2) mit einer Unterlegscheibe (1) und einer Autobloc-Mutter (1) M8 einlegen, **jedoch ohne anzuziehen**.

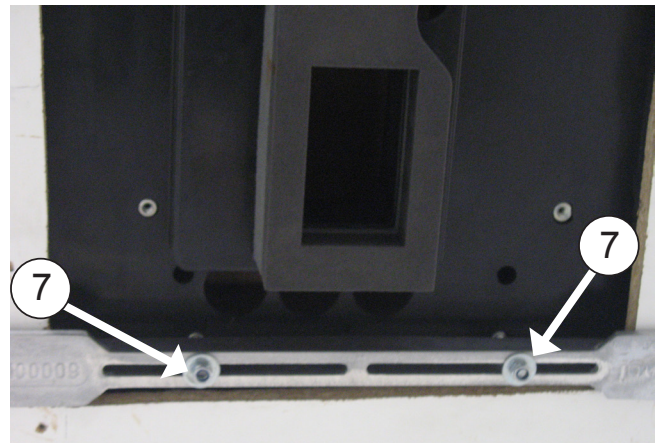

8 10 mm Gewinde für die Stiftschrauben (4) M6 x 80 am angegebenen Punkt schneiden laut Distanz (D) beschrieben in Abbildung 10.

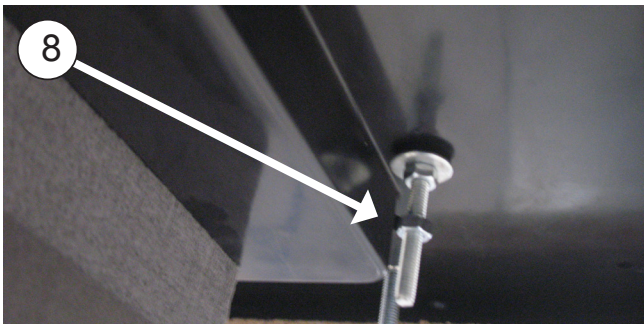
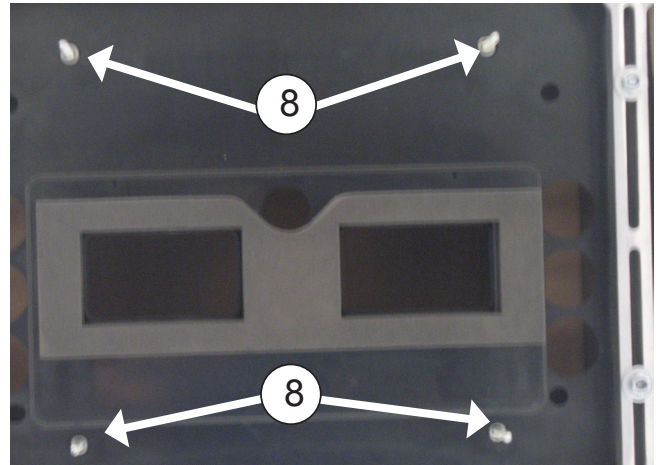

9 Montiere (1) Gummi-Unterlegscheibe, (1) 3D Unterlegscheibe (1) Mutter auf jede Gewindestange. Später ziehen Sie die Mutter an, bis die Gummischeibe ein wenig zusammengepresst ist.

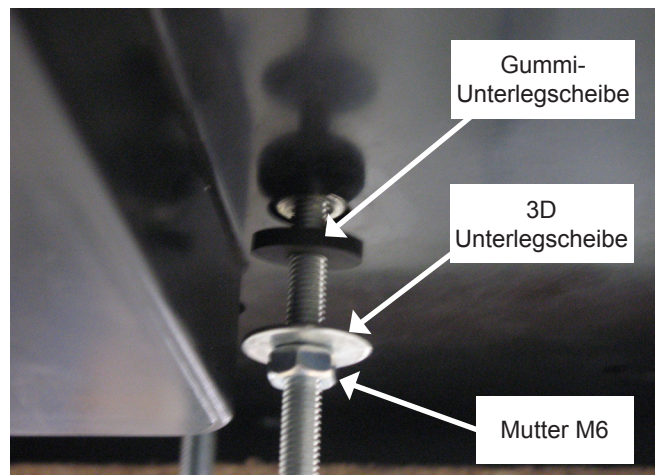

9a Jeweils die Mutter (1) M6 **ohne Anziehen** auf die Stiftschrauben legen.

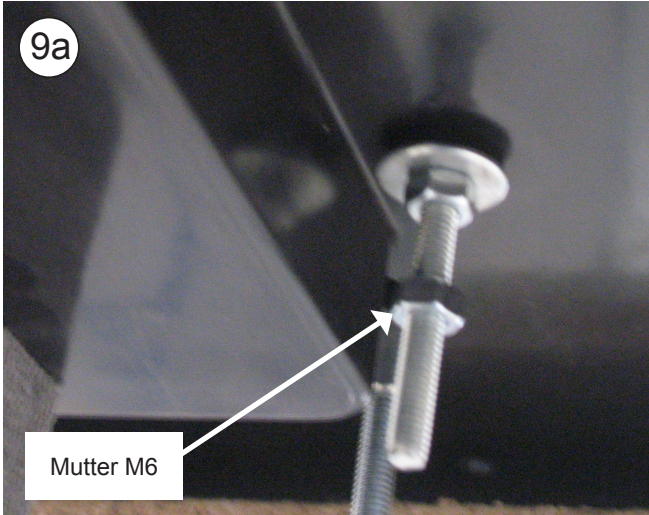

9b Zwischen der Grundplatte und der inneren Luftverteiltertafel (2) 2-Wege-Kästen von Frostschutzfühler (weiße Kabel) und Rückführsonde (schwarze Kabel), 4-Wege-Kasten des Gebläses, (2) Kommunikationskabel und 8-Wege-Kasten der Anschlussverkabelung zur Elektroniksteuerung anschließen.

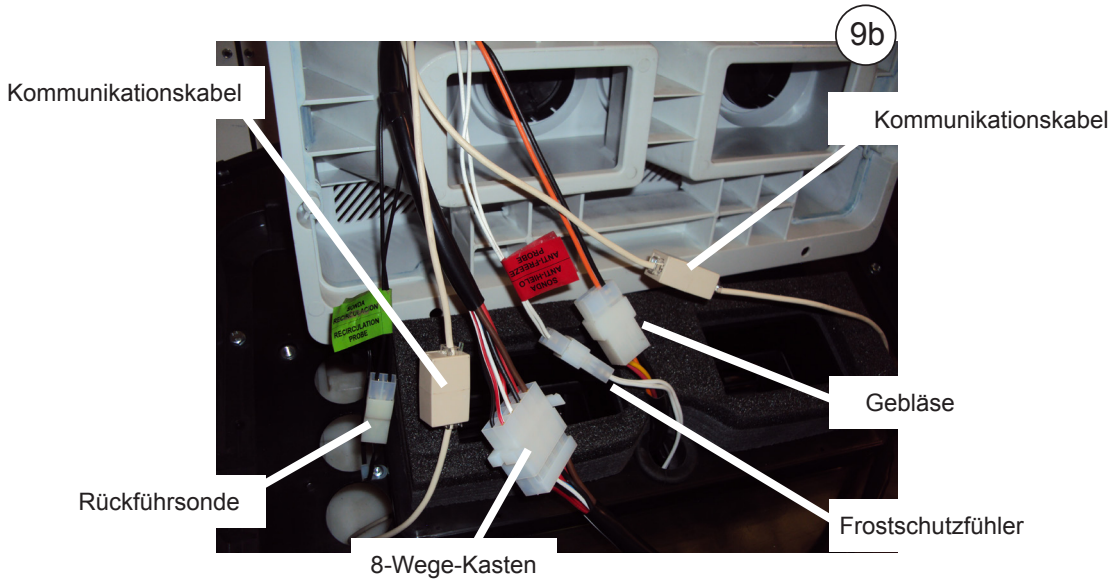

10

Luftverteiltertafel an den vorgenannten Stiftschrauben mit jeweils (1) Breitflansch-Unterlegscheibe M6 und (1) Mutter M6 anbringen. Muttern anziehen, bis die Führung der Luftverteiltertafel an der oberen Führungskupplung der Anlage anliegt.

Wichtiger Hinweis: Die Schaumstoffführung muss an den oberen Schaumstoff der Anlage stoßen, um das Entweichen von Luft zu vermeiden.

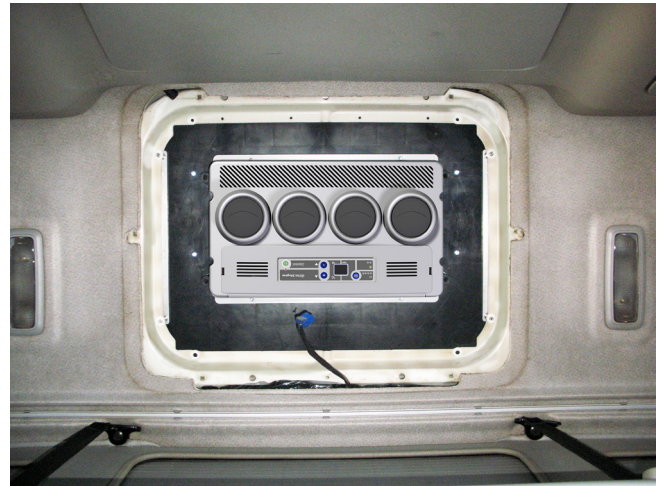

10

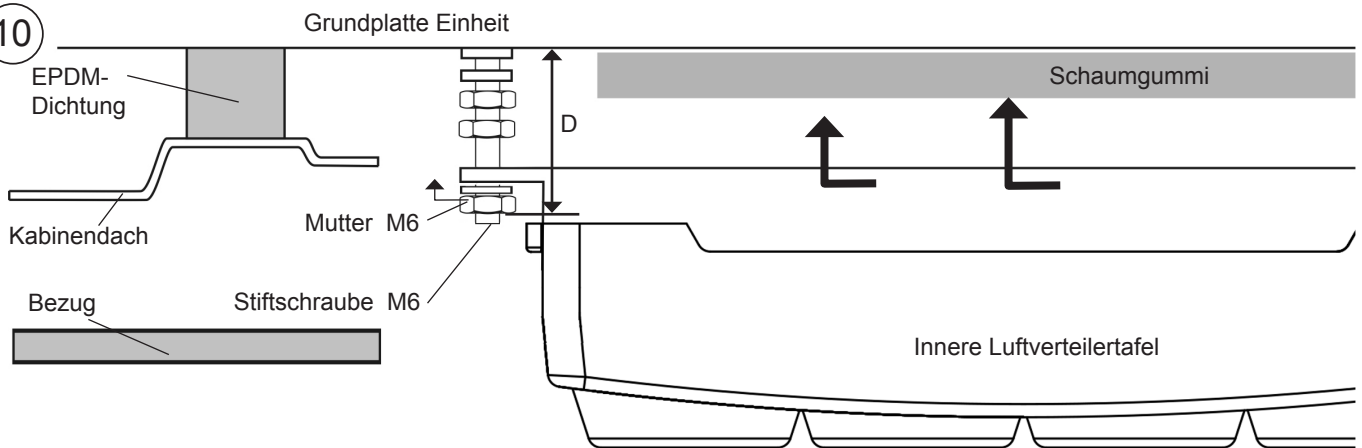

11

Mutter aus Punkt 9a anziehen, bis diese an das Oberteil der Luftverteiltertafel stößt.

11

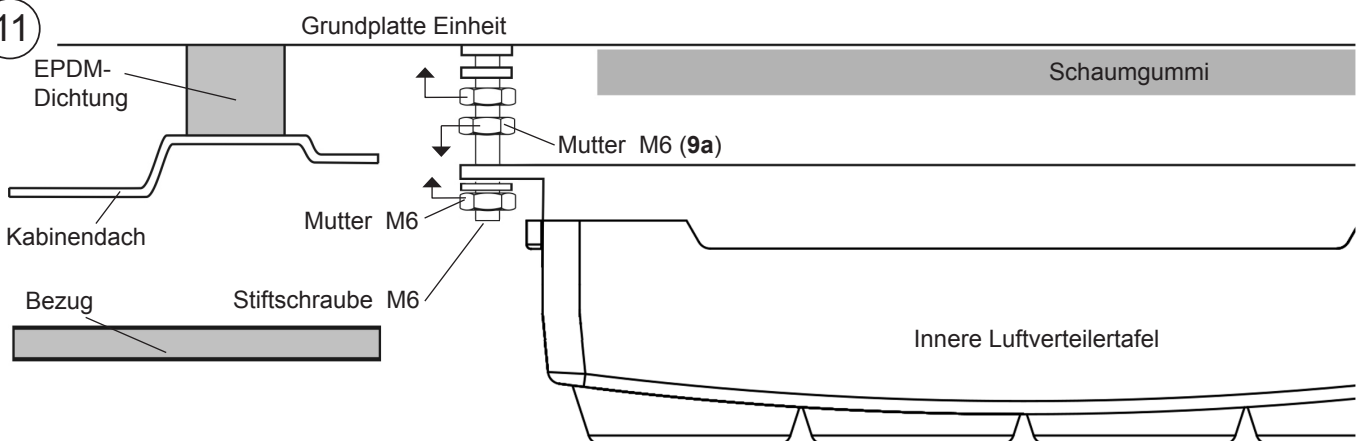

12 Konsole mit Originalschrauben platzieren und auf der Anlage in der geeignetsten Position zentrieren, bis die Originalschrauben in die entsprechenden Löcher passen.



13 Die Halterungen durch Anziehen der Muttern befestigen, bis die EPDM-Dichtung (**Punkt 4a**) des Geräts zwischen 3 und 6 mm komprimiert wird.

Wichtiger Hinweis: Um das Eindringen von Wasser in die Kabine zu verhindern, die die Verbindung der EPDM-Dichtung mit der Grundplatte des Compact wie in **Schema** gezeigt überprüfen.



Die Komprimierung der EPDM-Dichtung überprüfen anhand eines Stahlbaudmaßes in den vier Ecken.

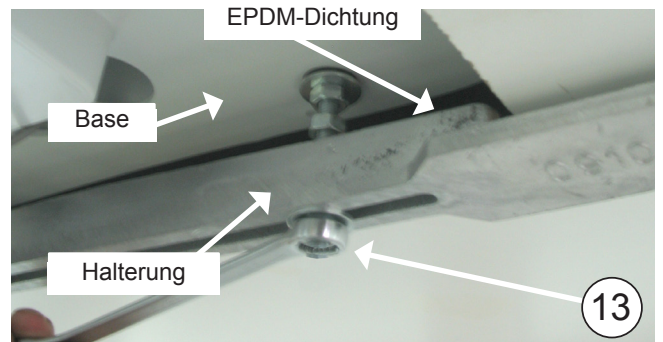
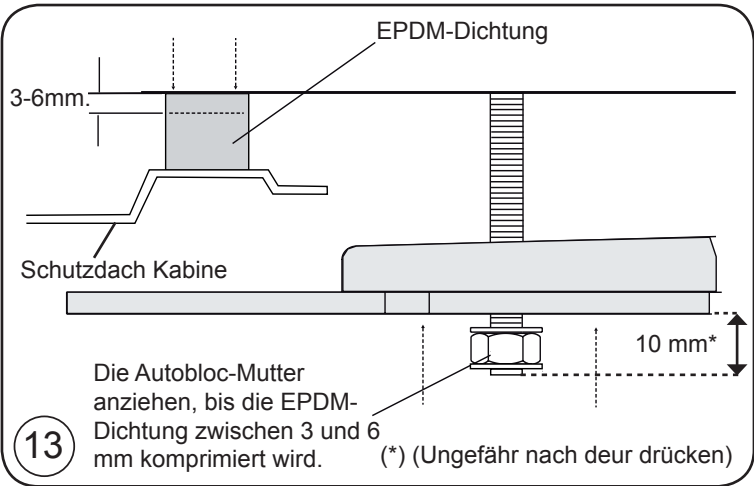

14 Die Muttern (4) M8 anziehen, um sie an der Grundplatte zu befestigen.

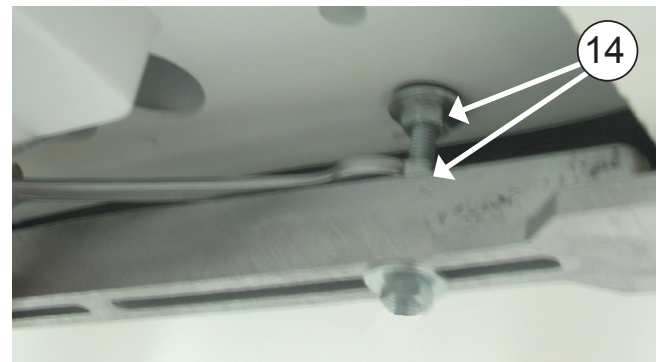

15 Befestigen Sie die Console mit 4 originalen Schrauben.



Explosionszeichnung bis zur befestigung der halter

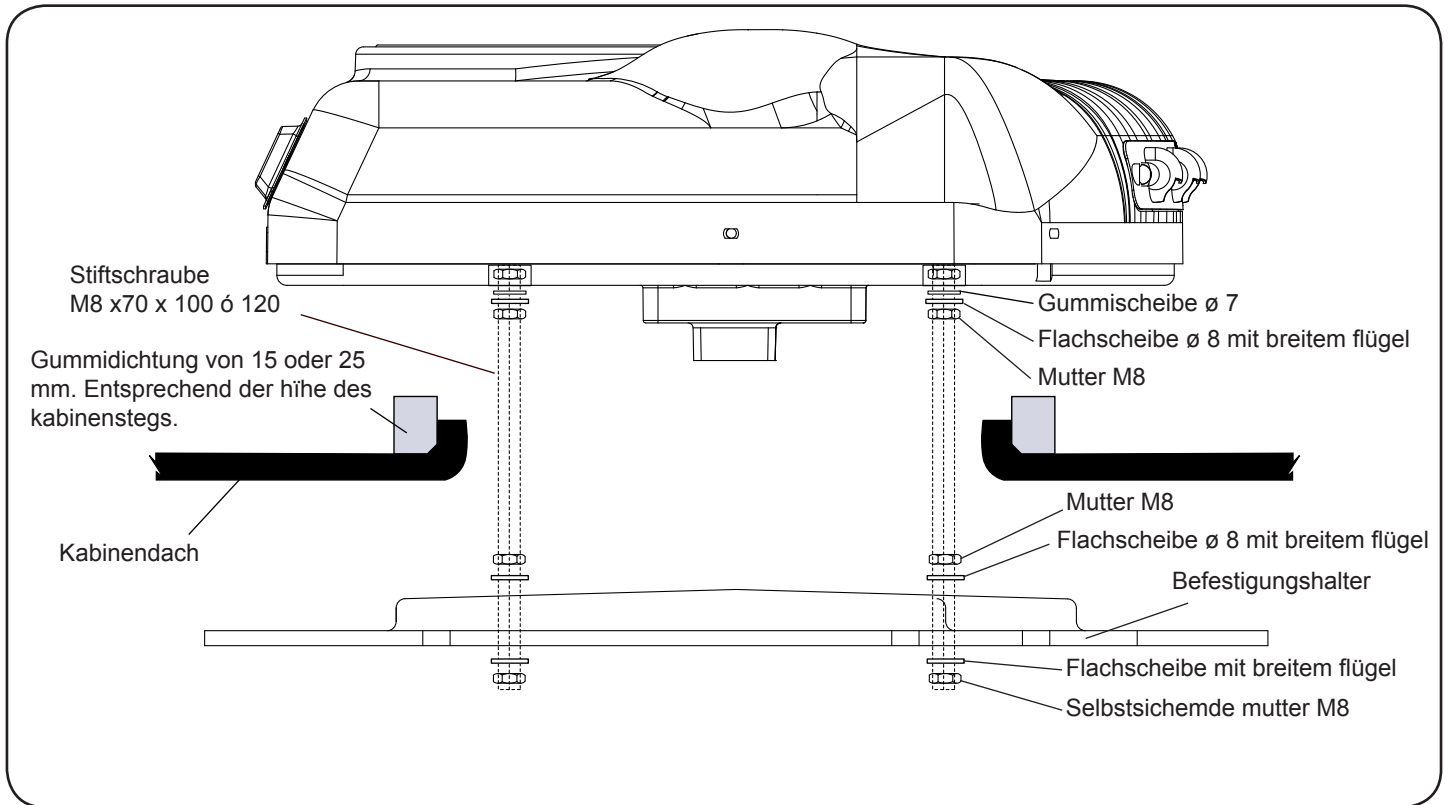

Explosionszeichnung bis zur befestigung der konsole

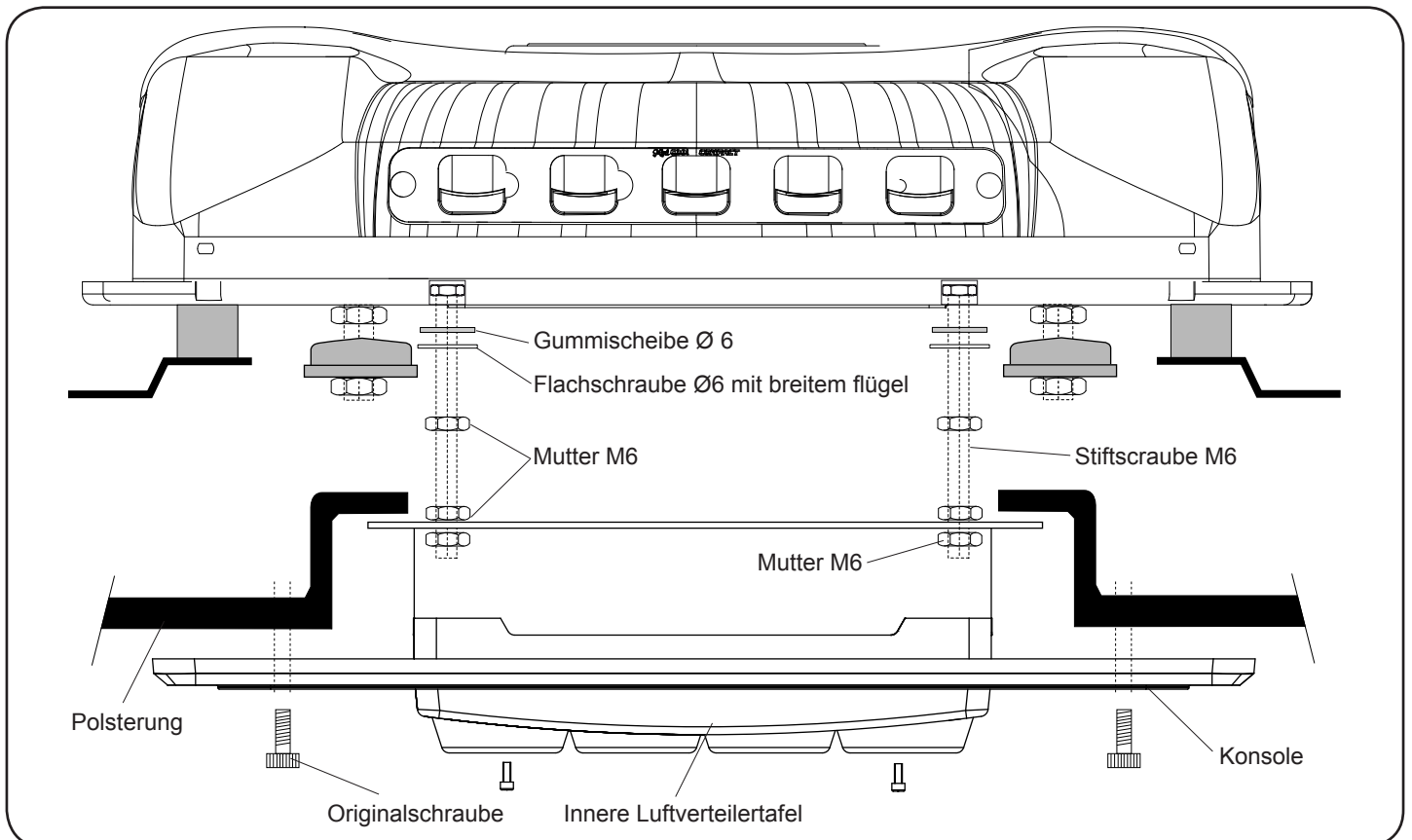

Detaillierte Anleitung für die Installation des Speisekabels

1 Speisekabelklemme an die Geräteklemme anschließen und das Kabel hinter der Zuführleitung durchführen.

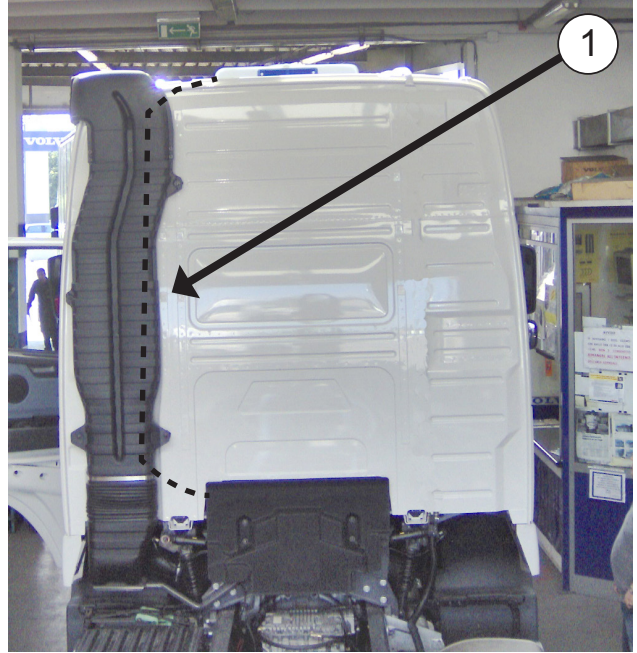
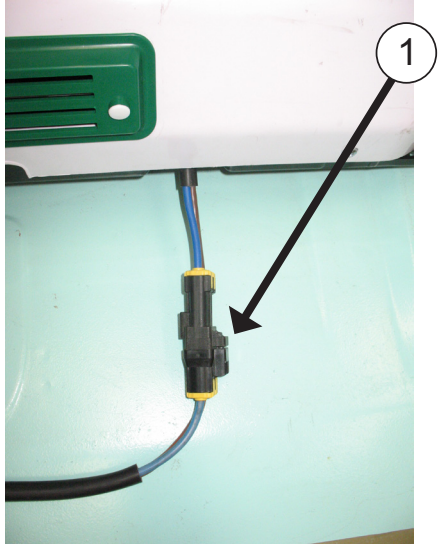

2 Kabine herunterklappen und das Kabel an der gezeigten Stelle bis zum Positivanschluss an der Vorderseite der Kabine entlang führen.

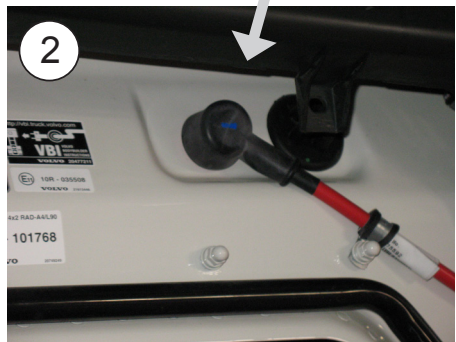
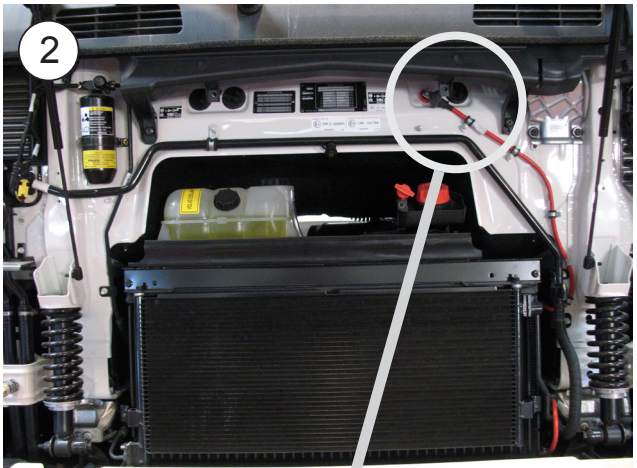
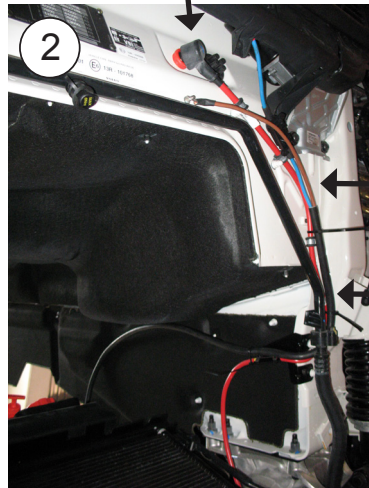
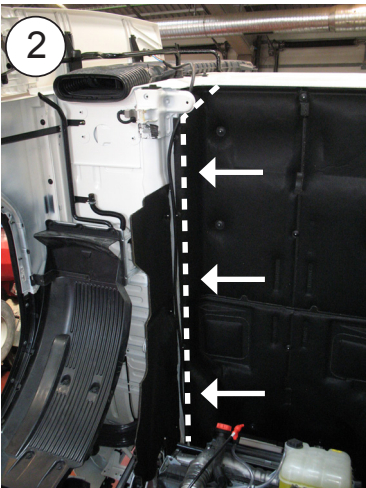

3 Mutter M6 und Mutter M8 des Positivanschlusses (+) abnehmen und Speisekabel wie gezeigt anschließen.

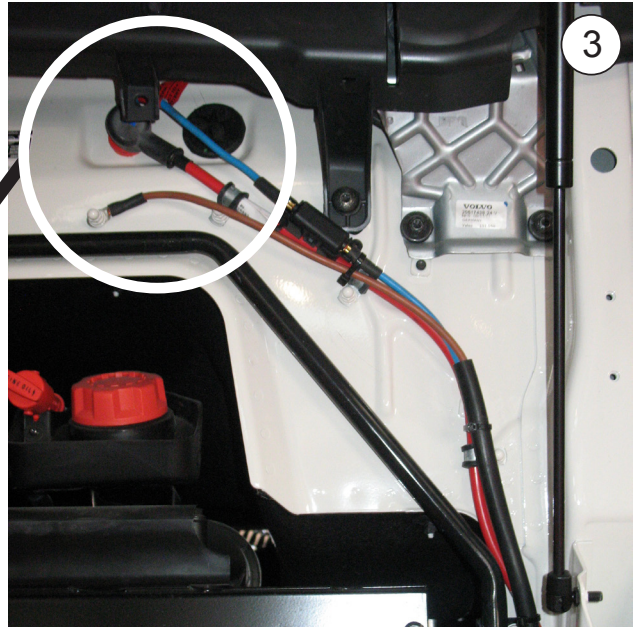
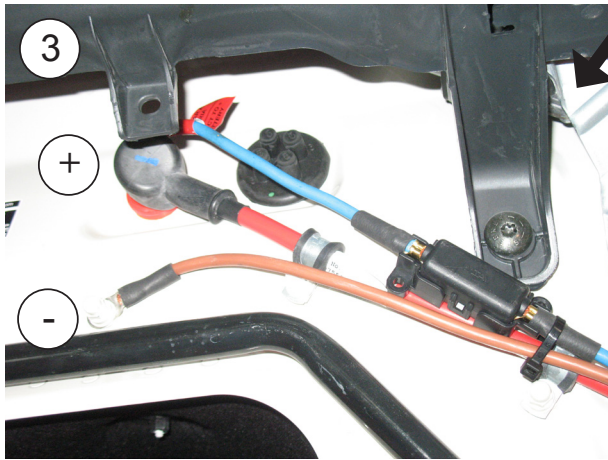

4 Kabel mit Kabelklemmen am Originalkabel befestigen.

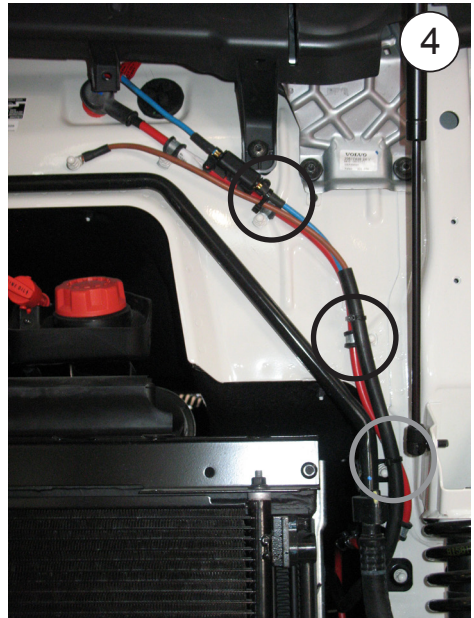

5 An der Unterseite mit Schellen an Original-Stiftschrauben befestigen.



6 Kabine herunterklappen und in Fahrtposition lassen, überschüssiges Kabel hinter die Zuführleitung stecken.



Elektrische Verkabelung

WICHTIGER WARHINWEIS!

Darauf achten, dass die Polaritäten beim Anschluss der Stromversorgung an das Gerät nicht vertauscht werden. Ist dies der Fall, schaltet sich die Elektroniktafel nicht ein, das Gerät funktioniert nicht und es kommt zu irreparablen Schäden an den Kompressormodulen.

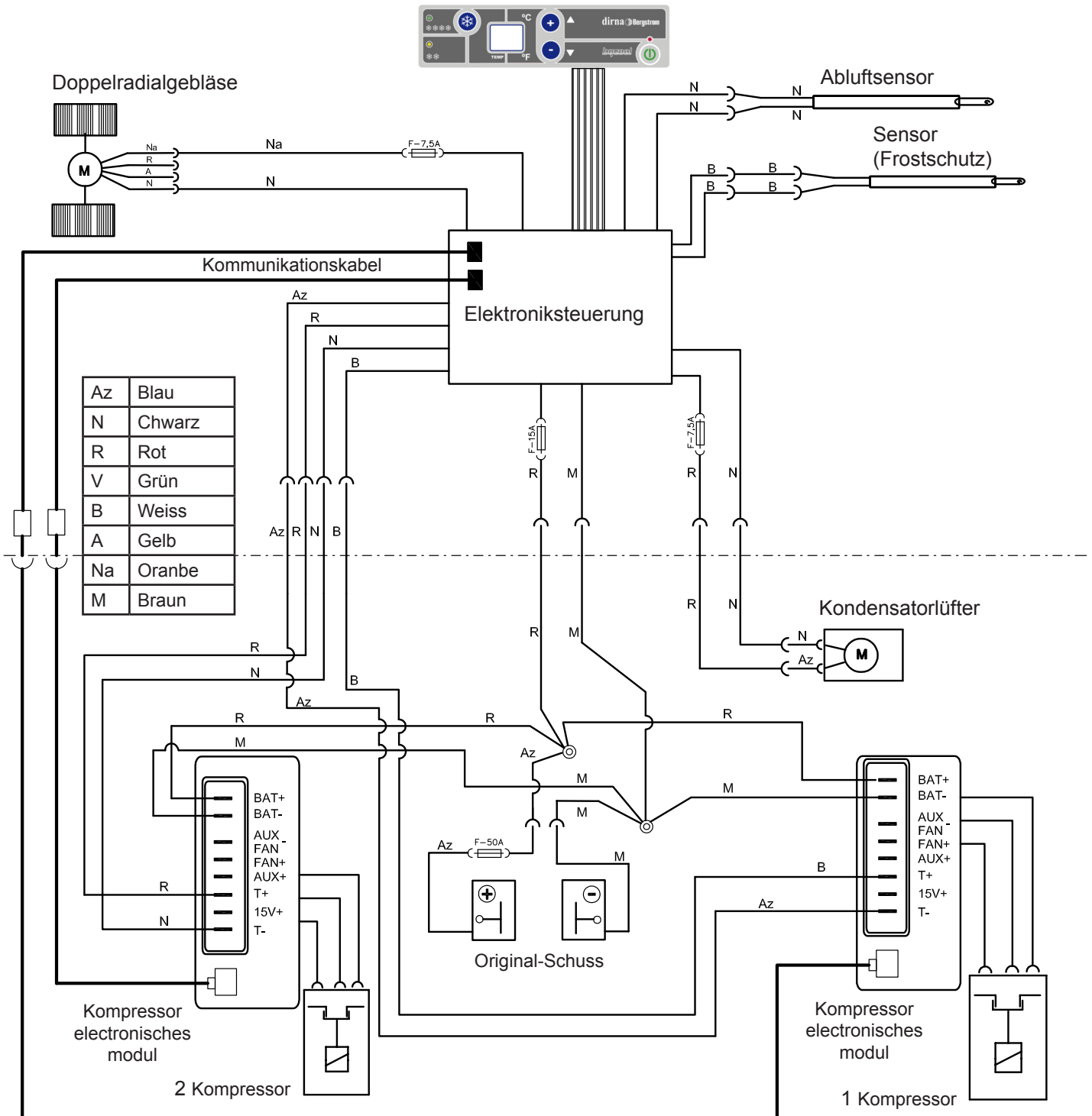

Suggerimenti per il montaggio

- Prima di cominciare il montaggio, leggere attentamente le istruzioni e rispettarle nel corso dello stesso.
- Usare gli attrezzi più adatti ad ogni operazione.

Elettricità

- Scollegare la chiave di contatto.
- Scollegare la batteria prima di cominciare il montaggio.
- Assicurarsi di avere effettuato correttamente l'installazione e il collegamento dei componenti elettrici.

Attenzione

Se durante il montaggio si inclina l'impianto, prima di rimetterlo in funzione occorre attendere almeno 60 minuti dal momento in cui è di nuovo in posizione orizzontale.

Attenzione

Quando si installa l'impianto di aria condizionata sul tettuccio, bisogna proteggere la parte superiore della cabina con uno straccio o una coperta per evitare eventuali graffi. Per l'installazione del **Compact**, tenere presente che normalmente le cabine munite di oblò dispongono di una struttura abbastanza solida per sostenere il peso dell'impianto. Tuttavia, se così non fosse e se fosse necessario tagliare il tettuccio, o se in presenza di oblò la struttura non fosse abbastanza rigida (se fosse di fibra, plastica, ecc.), è responsabilità dell'installatore decidere se occorre rinforzare il tettuccio per evitare qualsiasi deformazione, rottura o penetrazione d'acqua, ecc., prendendo le misure necessarie per evitarlo.



Attrezzi

- Kit di chiavi Torx
- Kit di chiavi Allen
- Chiave fissa 10, 13, 14
- Forbici
- Metro a nastro







Documentazione allegata

Istruzioni di montaggio	1001217164
Guida dell'utente	1001218019
Soluzione dei problemi	1001218025
Garanzia	220AA10017

Simbologia

-  Fragile
-  Attenzione alle mani
-  Tensione elettrica pericolosa

Avvertenze

-  L'installatore deve essere in possesso della formazione necessaria in materia di aria condizionata per veicoli.
-  **dirna Bergstrom, s.l.** declina ogni responsabilità per danni o rotture derivanti dall'errata installazione o dall'errato uso dell'impianto o da sostituzioni o modifiche effettuate senza la necessaria autorizzazione per iscritto.
-  **Impianto precaricato con gas refrigerante. (Non manomettere il circuito di gas refrigerante).**
-  Vedi la **procedura di garanzia** del prodotto in **Diagnosi dei problemi**.
-  Vedi la **Guida dell'utente** dell'impianto per il corretto funzionamento del telecomando e del pannello di controllo.
-  I seguenti documenti devono essere consegnati all'utente una volta conclusa l'installazione: **Guida dell'utente, Garanzia e Diagnosi dei problemi**.

 Prima di iniziare il montaggio, installare la griglia sull'entrata anteriore dell'aria.



1 Desmontar tapa escotilla, marco interior y entregar al cliente

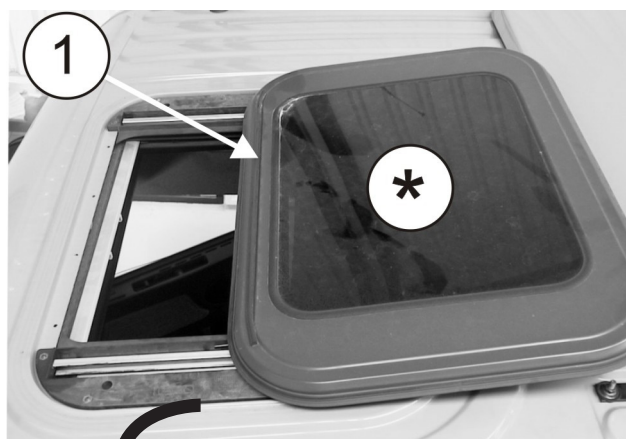

2 Incollare guarnizione EPDM di 30x25mm, intorno al taglio o al vano del tettuccio.





COME TAGLIARE LA GUARNIZIONE EPDM PER EVITARE INFILTRAZIONI NELLA CABINA

A- Incollare la guarnizione mantenendo una protezione di carta di 100 mm su ogni lato.

B- Rimuovere i due pezzi di carta.

C- Incollare premendo su entrambe le estremità.

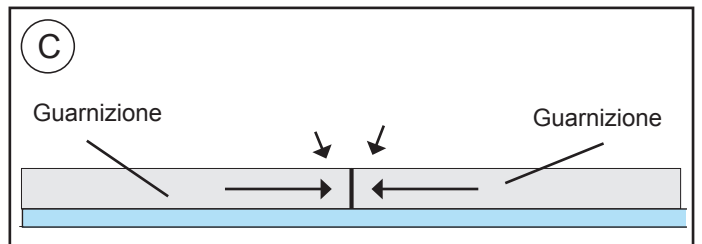
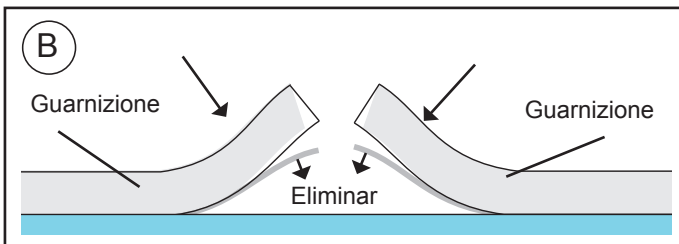
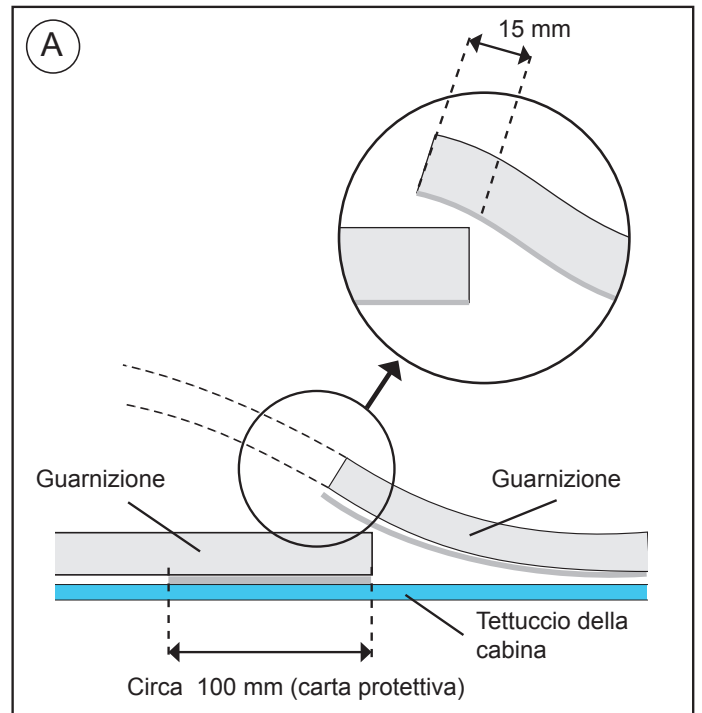

3 **ESTERNO CABINA:**

Collocare il **Compact** nel vano.

Attenzione! Quando si posiziona l'impianto sul vano del tettuccio apribile, controllare che le uscite di scarico non siano ostruite dalla guarnizione EPDM.

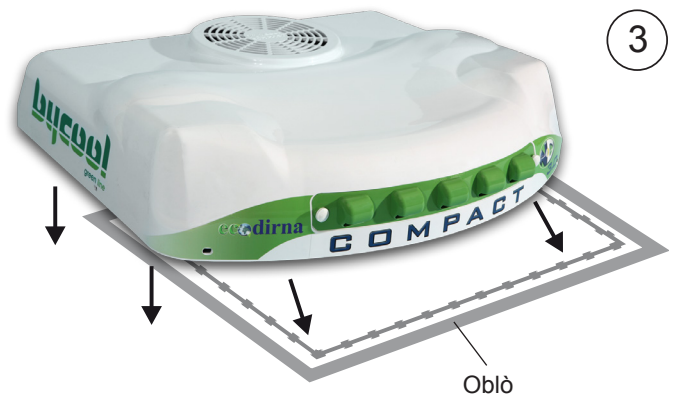

4 Posizionare il canalizzatore di gommapiuma con la parte più morbida sulla base dell'impianto.

Attenzione: A seconda della cabina, può essere necessario usare i (2) canalizzatori in dotazione per la completa adesione del pannello di distribuzione dell'aria ai medesimi.



5 **INTERNO CABINA:**

Avvitare di circa 5 mm le (4) viti prigioniera da 8/125x70, 100 o 120 mm, a seconda della distanza (maggiore o minore) dall'impianto finché, posizionando i supporti di fissaggio, le viti non sporgono di 20 mm dagli stessi.

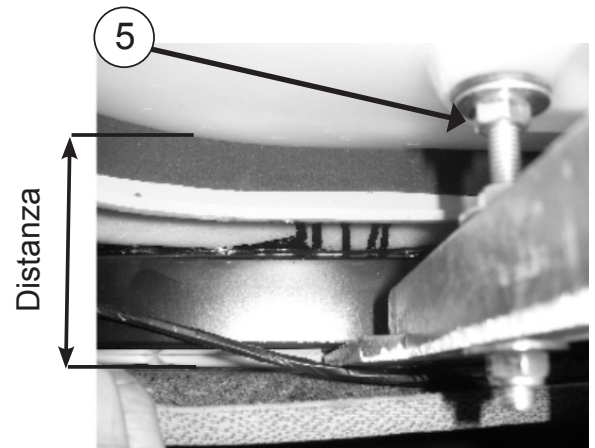
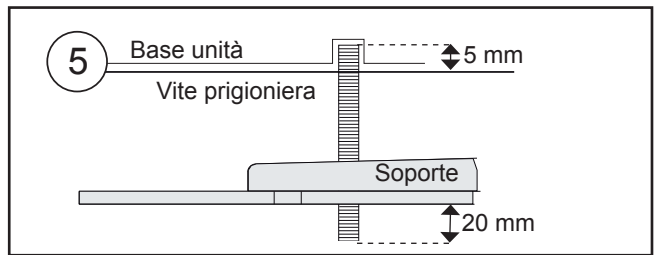

6 Inserire (8) rondella di gomma Ø 7, (1) rondella piana Ø 1 a testa larga, (2) dadi M8 e (1) rondella piana Ø 8 a testa larga, su ciascuna vite prigioniera precedente, seguendo questo ordine.

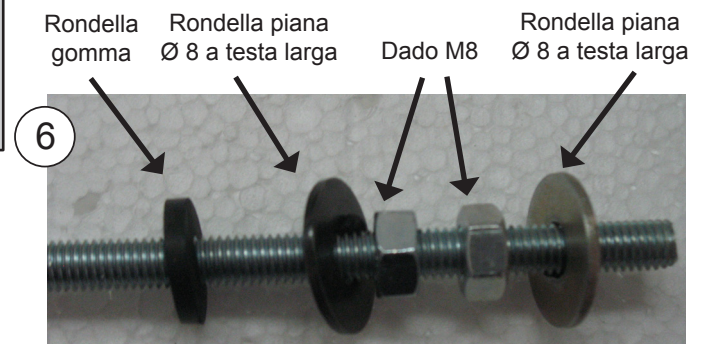

7

Fissare i supporti di fissaggio (2), con una rondella (1) e un dado autobloccante (1) M8, senza stringere.

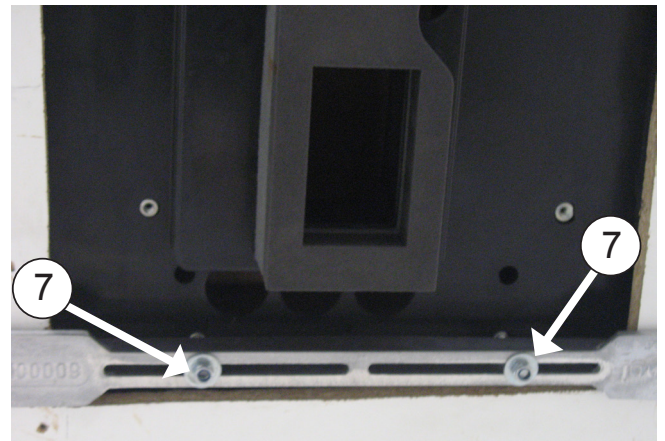

8

Avvitare di 10 mm i perni (4) M6 x 80, dove indicato distanza (A) segun nella a figura 10.

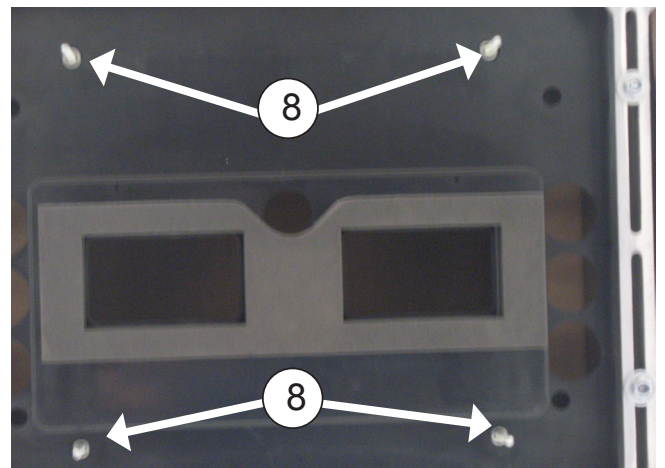
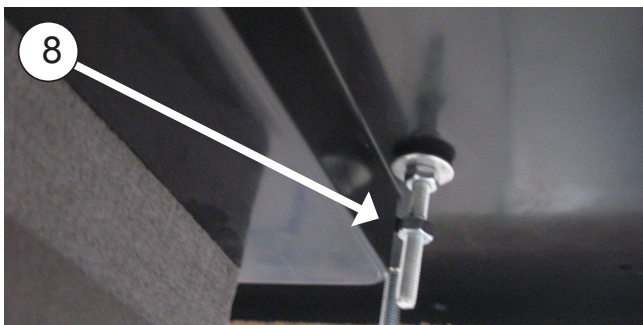

9

Inserire (1) rondella Ø 6 di gomma, (1) rondella piana Ø 6 a testa larga e (1) dado M6 su ogni vite prigioniera M6. Quindi stringere il dado fino a premere leggermente la rondella di gomma.

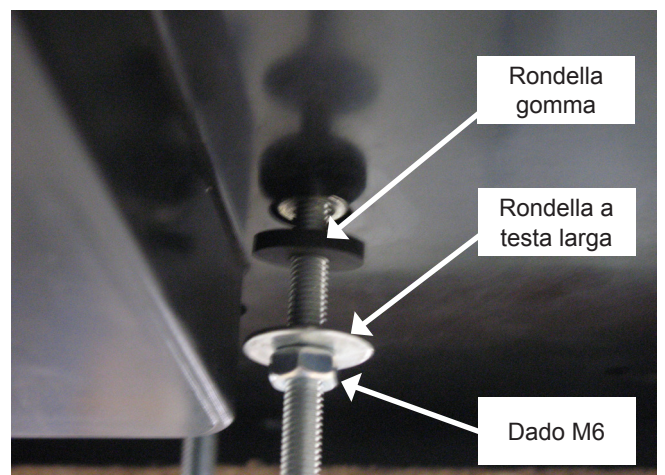

9a Inserire il dado (1) M6 **senza stringere** in ogni vite prigioniera.

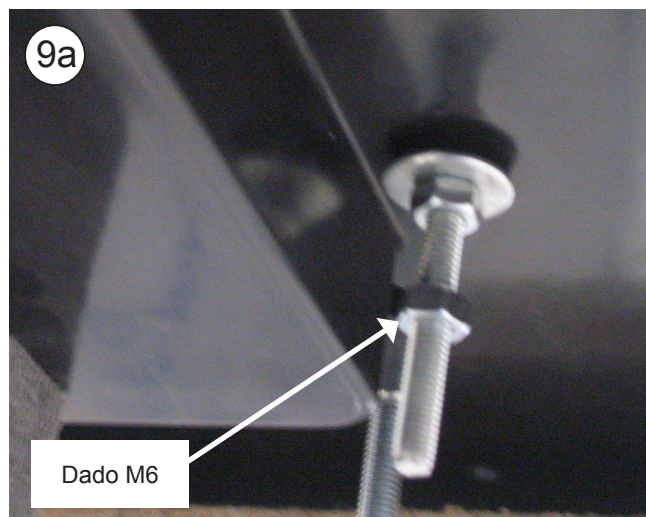

9b Tra la base e il pannello interno di distribuzione dell'aria, collegare (2) scatole a due vie del sensore antigelo (cavi bianchi) e del sensore dell'aria di ritorno (cavi neri), la scatola a 4 vie del ventilatore, (2) cavi di comunicazione e la scatola a 8 vie del cablaggio di connessione con il controllo elettronico.

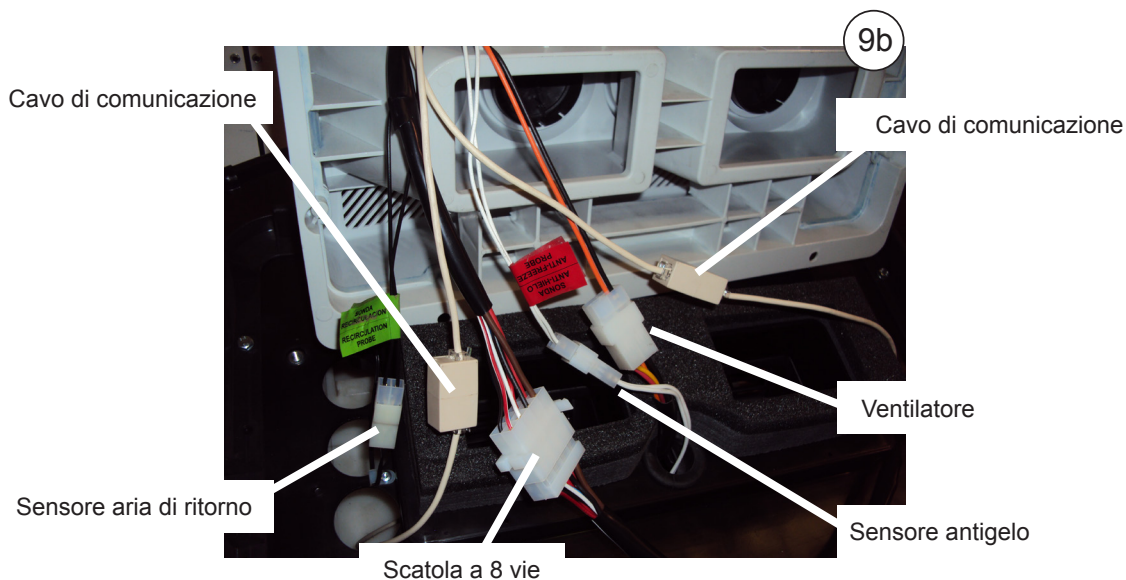

10 Posizionare il pannello di distribuzione dell'aria sulle viti prigioniera anteriori con (1) rondella M6 a testa larga e (1) dado M6 su ogni vite prigioniera. Stringere i dadi finché il canalizzatore del pannello di distribuzione dell'aria non è a battuta sulla sede del canalizzatore presente sull'impianto.

Nota bene: il canalizzatore di gommapiuma deve essere a battuta sulla gommapiuma superiore dell'impianto per evitare perdite d'aria.

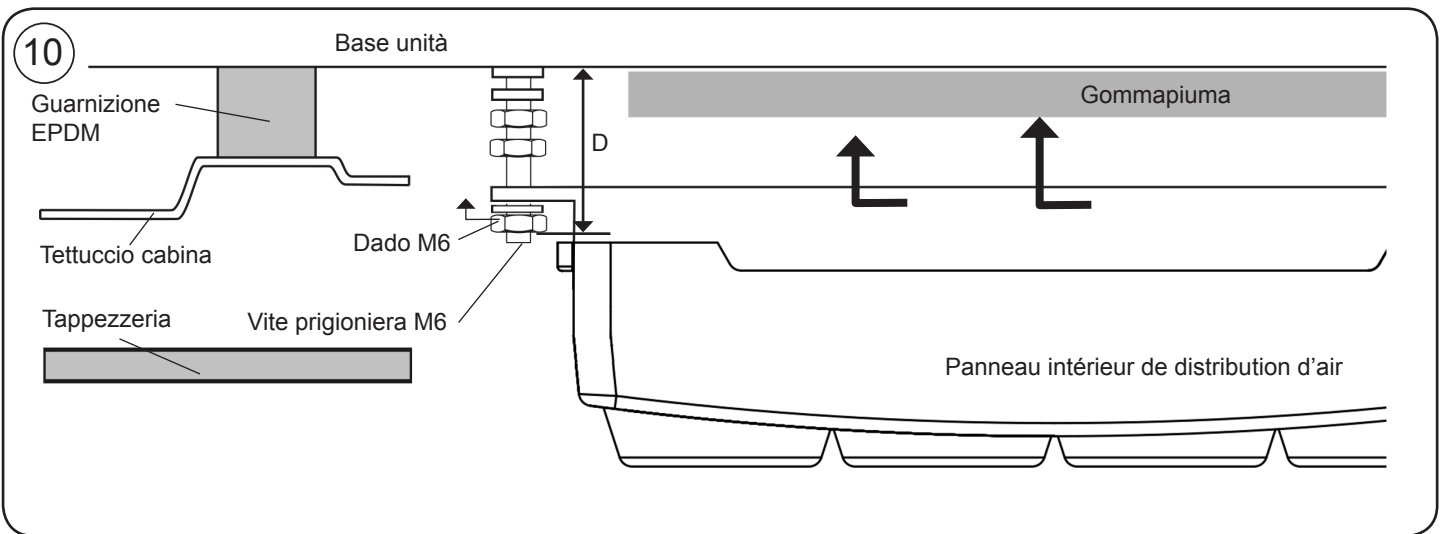
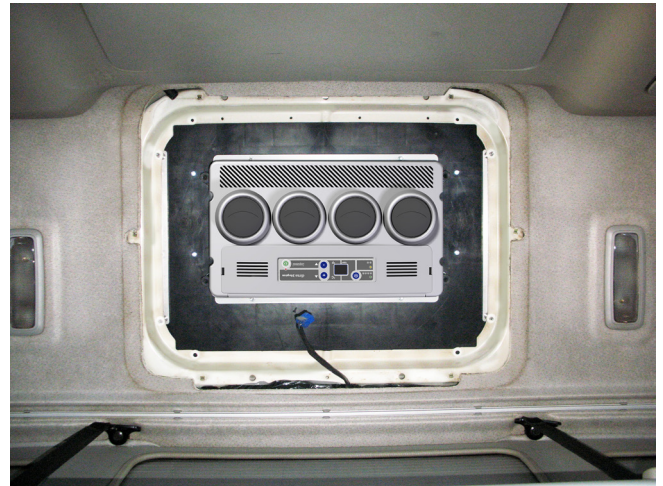

11 Stringere il dado del punto 9a fino a battuta con la parte superiore del pannello interno di distribuzione dell'aria.

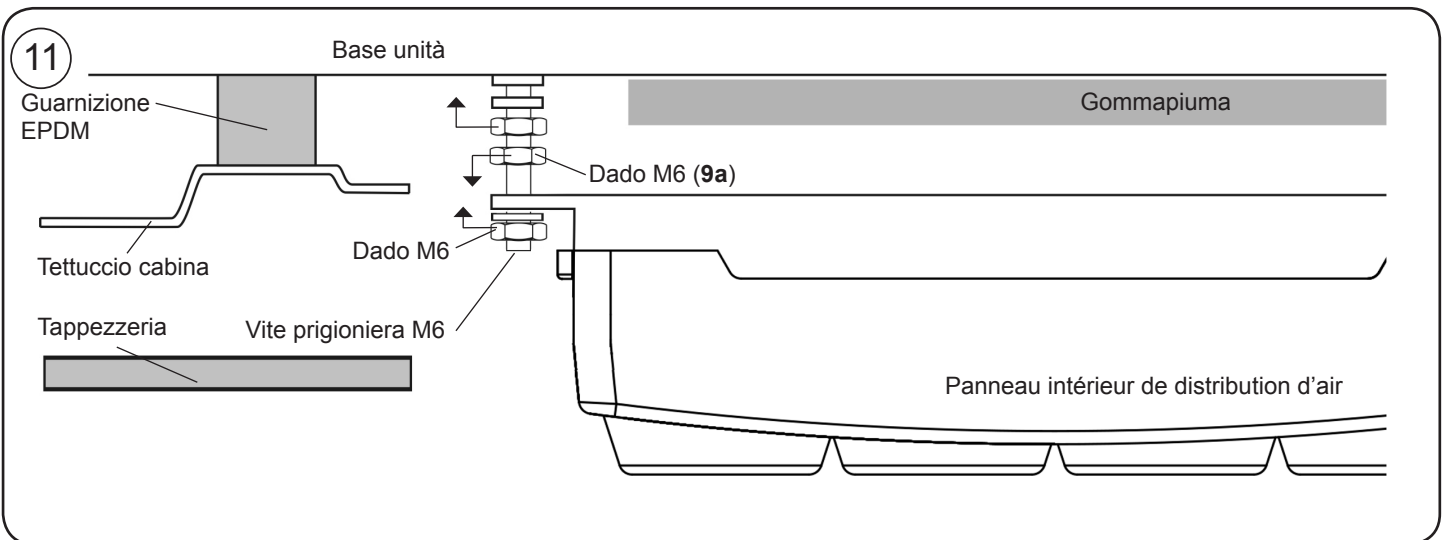

12 Posizionare provvisoriamente la console con le viti originali e centrare l'impianto nella posizione più adatta fino a far coincidere le viti originali con la loro ubicazione.



13 Fissare i supporti stringendo i dadi fino a comprimere, tra 3 e 6 mm, la guarnizione EPDM dell'impianto.

Nota bene: Per evitare che infiltrazioni d'acqua nella cabina, verificare il serraggio della guarnizione EPDM con la base Compact base, come illustrato nel Diagramma.



Comprovare la compressione della guarnizione EPDM usando un flexómetro nelle quattro angoli.

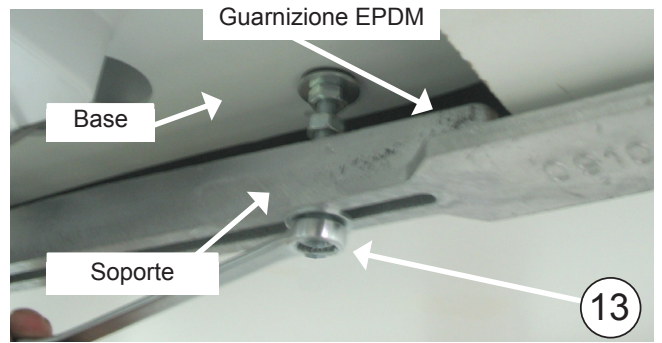
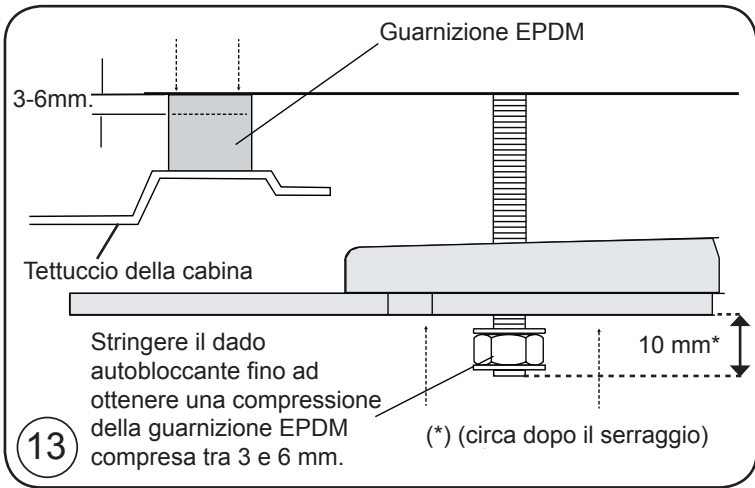

14 Stringere i dadi (4) M8 per fissare a (4) l'unità base.

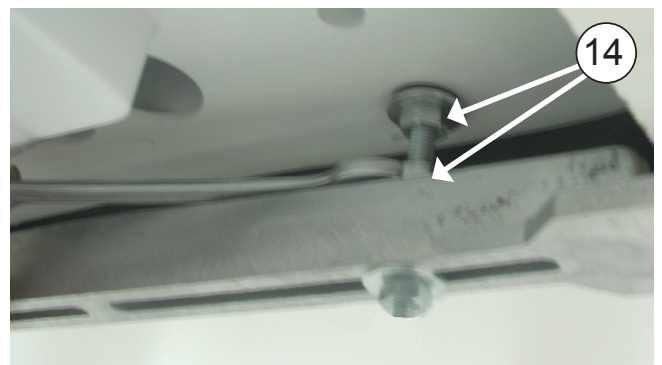

15 Luogo console con 4 viti originale.



Vista dettagliata fino al fissaggio dei supporti

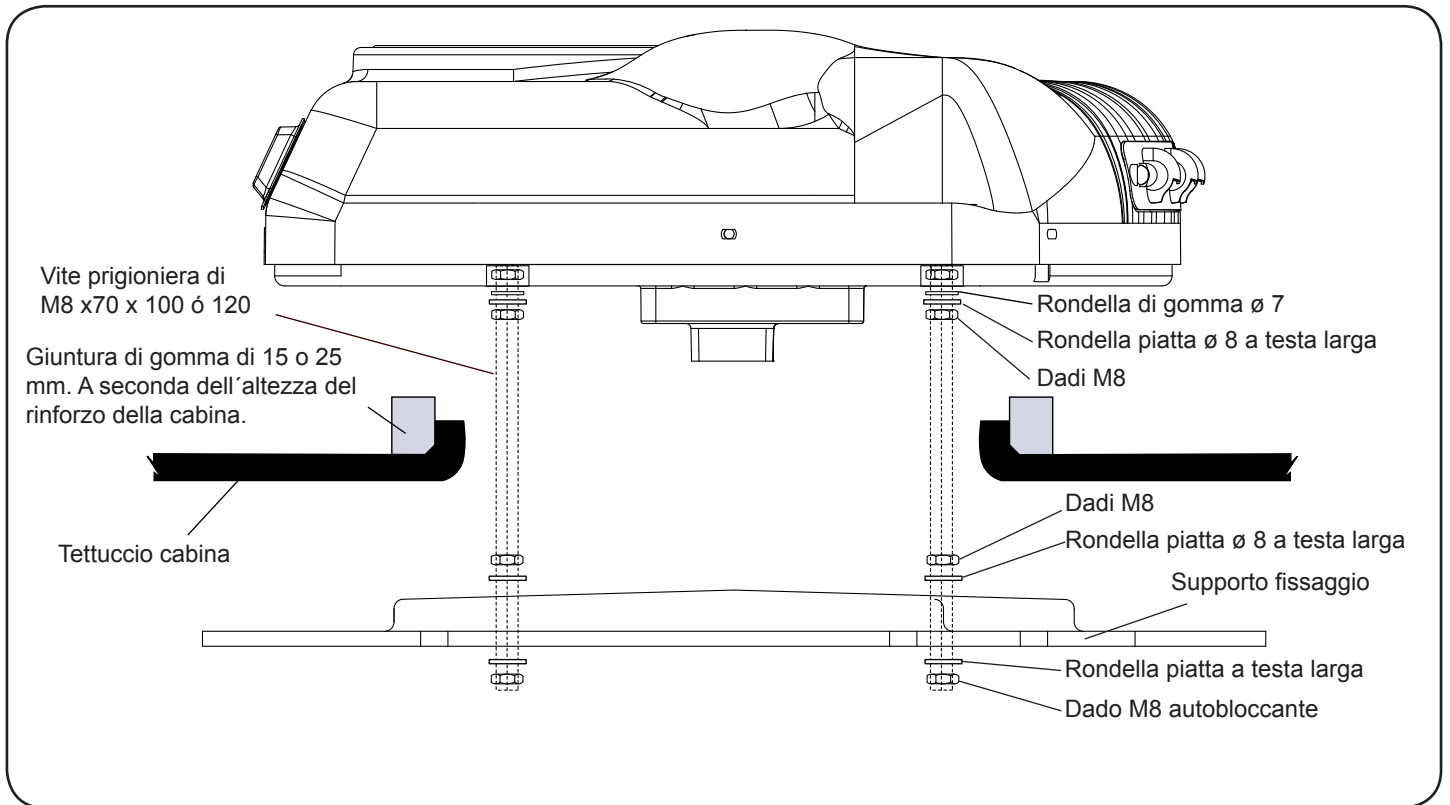

Vista dettagliata fino al fissaggio della consolle

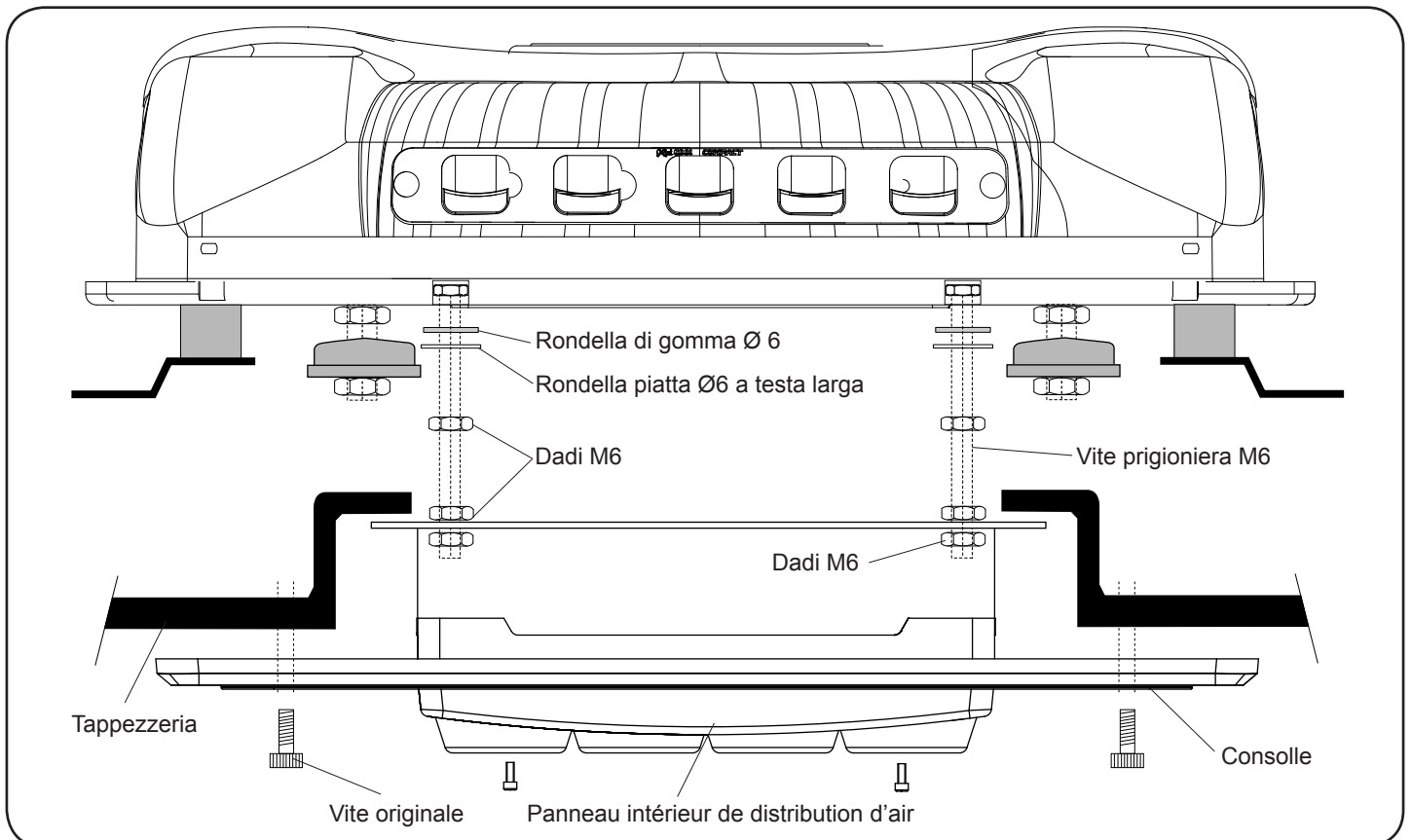

Istruzioni particolareggiate per l'installazione del cavo di alimentazione

1 Collegare il morsetto del cavo di alimentazione con il morsetto dell'impianto e fare passare il cablaggio dietro il tubo di aspirazione.

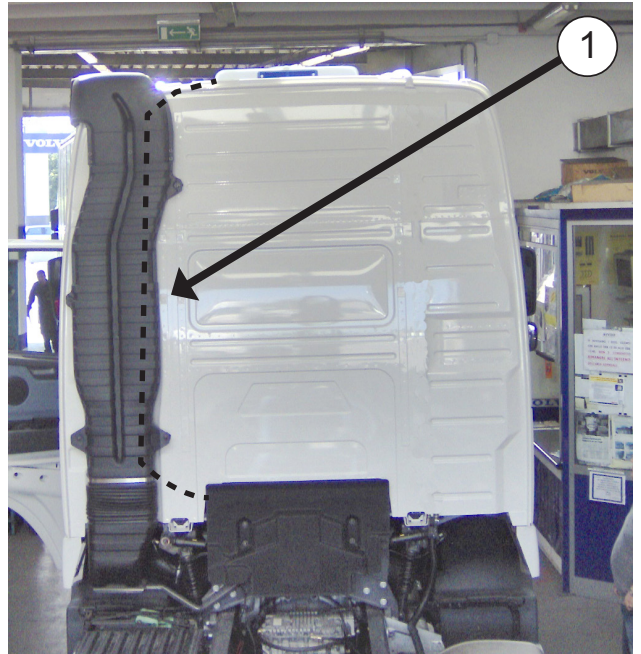
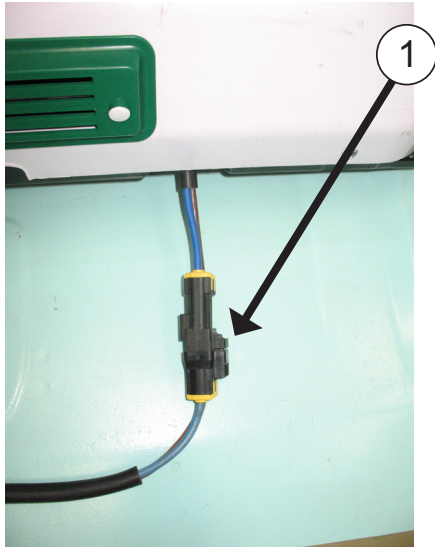

2 Ribaltare la cabina e condurre il cavo dal sito indicato fino alla presa (+) situata nella parte anteriore della cabina.

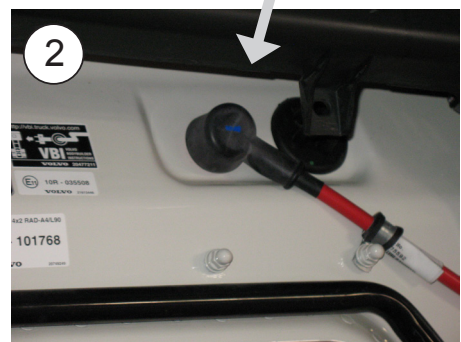
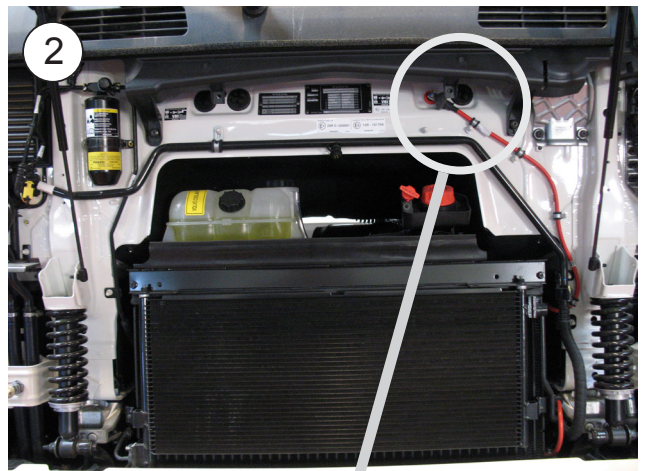
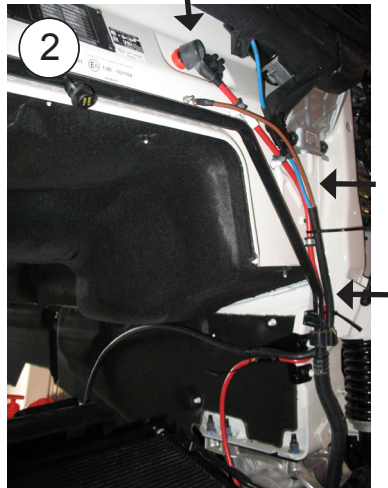
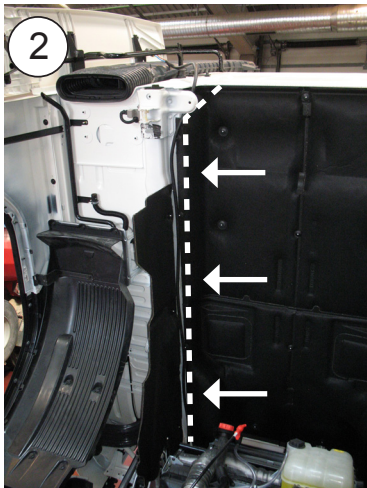

3 Smontare il dado M6 e il dado M8 della presa (+) e collegare il cavo di alimentazione come indicato.

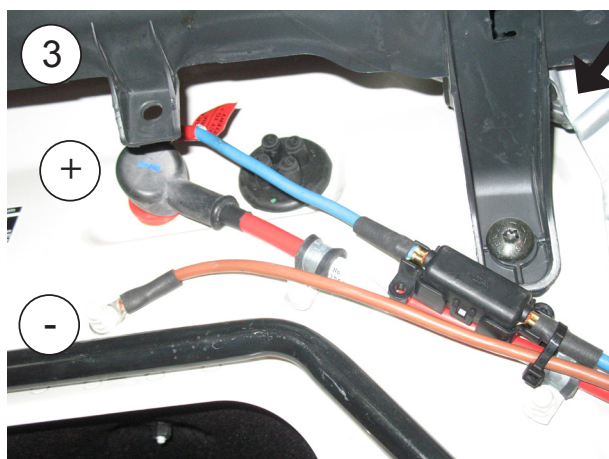
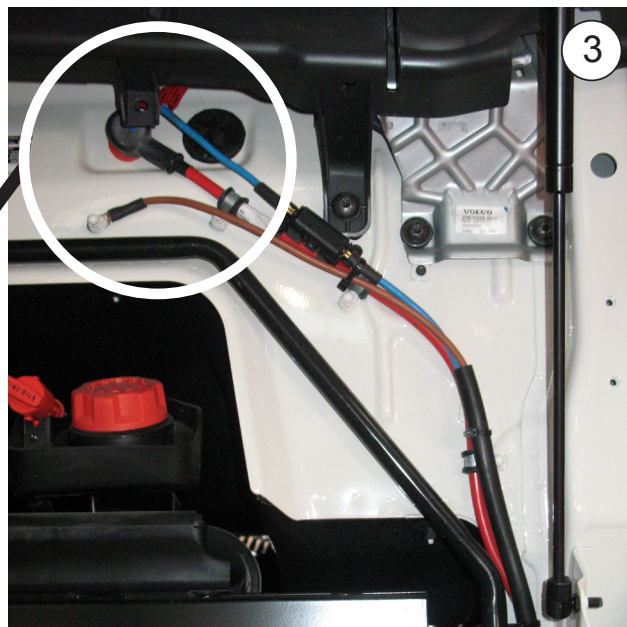

4 Con le flange fissare il cavo a quello originale.



5 Nella parte inferiore, fissare con fascette alle viti prigioniere originali.

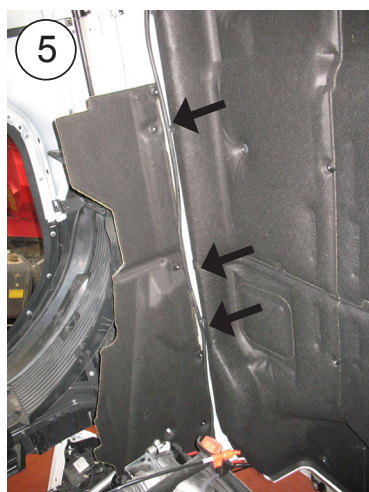

6 Ribaltare la cabina e lasciare in posizione di avvio, nascondere il cavo che avanza dietro il tubo di aspirazione.



Cablaggio elettrico

AVVISO IMPORTANTE!

Fare attenzione a non invertire le polarità effettuando la connessione dell'alimentazione all'impianto, altrimenti il quadro comandi non si accende, l'impianto non funziona e si potrebbero verificare danni irreparabili ai moduli dei compressori.

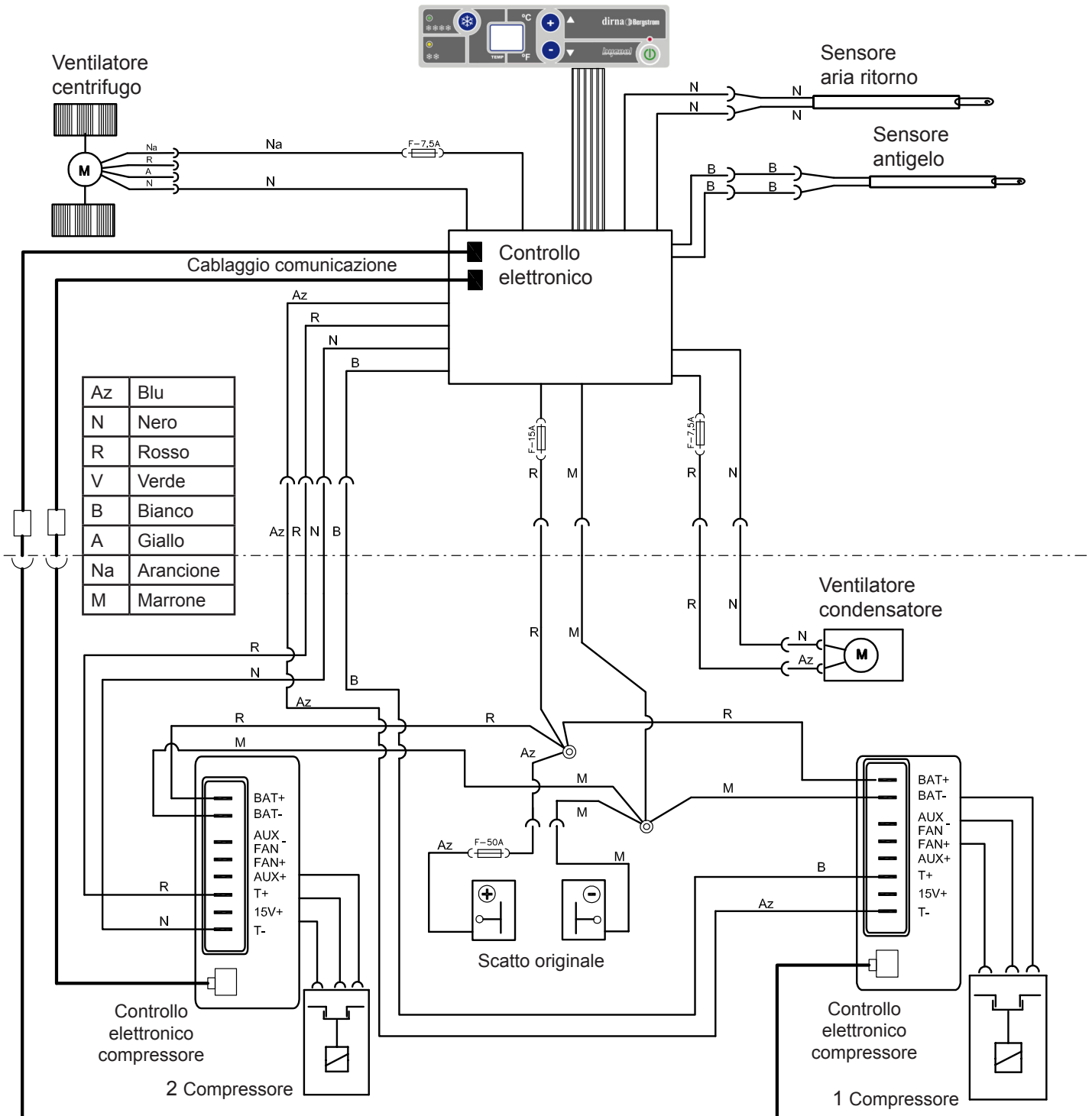

Ed:	20/01/2016
Md:	05/11/2018

a



Francisco Alonso, 6
28806 Alcalá de Henares, Madrid
SPAIN

Contact	Phone	Fax	E-Mail
Sales (Ventas Internacional)	+34 91 8770510	+34 91 8771158	sales@dirna.bergstrominc.com
Comercial Nacional	+34 91 8775841	+34 91 8836321	ventas@dirna.bergstrominc.com
Orders & Deliveries (Logística internacional)	+34 91 8775846	+34 91 8771158	export@dirna.bergstrominc.com
Orders & Deliveries (Logística nacional)	+34 91 8775840	+34 91 8836321	comercial@dirna.bergstrominc.com
Technical Assistance (Internacional)	+49 511 86679681	+49 511 86679710	technicalassistance@dirna.bergstrominc.com
Technical Assistance (Nacional)	+34 91 8775845	+34 91 883 6321	oblanco@dirna.bergstrominc.com

www.dirna.com

	ATENCIÓN:	Dirna Bergstrom se reserva el derecho de efectuar modificaciones en cualquier momento de los datos contenidos en esta publicación, por razones técnicas o comerciales.
	NOTE:	<i>For technical and commercial reasons, Dirna Bergstrom reserves the right to change the data contained in this brochure.</i>
	ATTENTION:	Dirna Bergstrom se réserve le droit d'effectuer à tout moment des modifications des données reprises sur cette publication, pour des raisons techniques ou commerciales.
	HIWEIS:	<i>Dirna Bergstrom behält sich vor, aus technischen oder kaufmännischen Gründen jederzeit Änderungen der Angaben dieser Veröffentlichung vorzunehmen.</i>
	ATTENZIONE:	Dirna Bergstrom si riserva il diritto di effettuare modifiche in qualsiasi momento ai dati contenuti in questa pubblicazione, per motivi tecnici o commerciali.